

174197-1 ✓ ACTIVE

FASTIN-FASTON | FASTIN-FASTON 250

TE Internal #: 174197-1

Crimp Terminal Housings, Tab, Tab Housing, 2 Position, Straight,
UL 94V-2, Natural, Nylon, Mating Alignment, FASTIN-FASTON 250

[View on TE.com >](#)



Terminals & Splices > Terminal Housings, Insulation Sleeves & Blocks > Crimp Terminal Housings

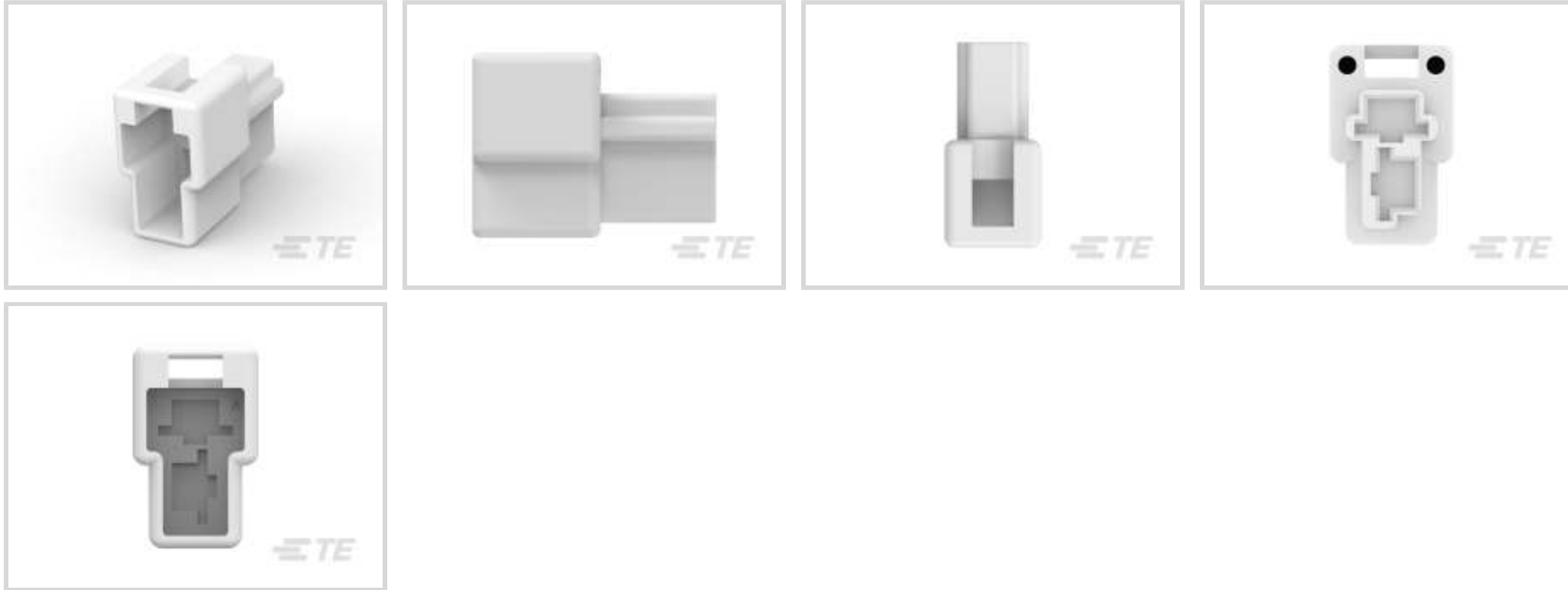

Terminal Type: **Tab**

Connector & Housing Type: **Tab Housing**

Number of Positions: **2**

Terminal Orientation: **Straight**

UL Flammability Rating: **UL 94V-2**

Features

Product Type Features

Sealable	No
Connector & Contact Terminates To	Wire & Cable
Connector & Housing Type	Tab Housing

Configuration Features

Number of Positions	2
---------------------	---

Body Features

Primary Product Color	Natural
-----------------------	---------

Contact Features

Terminal Type	Tab
Terminal Orientation	Straight
Contact Mating Retention	Without

Mechanical Attachment

Mating Alignment	With
Connector Mounting Type	Cable Mount (Free-Hanging)

Housing Features

Housing Material	Nylon
------------------	-------

Dimensions

Product Length	28.5 mm[1.12 in]
----------------	------------------

Usage Conditions

Operating Temperature Range	-40 – 105 °C[-40 – 221 °F]
-----------------------------	----------------------------

Industry Standards

UL Flammability Rating	UL 94V-2
------------------------	----------

Packaging Features

Packaging Quantity	500
--------------------	-----

Product Compliance

[For compliance documentation, visit the product page on TE.com>](#)

EU RoHS Directive 2011/65/EU	Compliant
EU ELV Directive 2000/53/EC	Compliant
China RoHS 2 Directive MIIT Order No 32, 2016	No Restricted Materials Above Threshold
EU REACH Regulation (EC) No. 1907/2006	Current ECHA Candidate List: JUNE 2023 (235) Candidate List Declared Against: JAN 2023 (233) Does not contain REACH SVHC
Halogen Content	Low Halogen - Br, Cl, F, I < 900 ppm per homogenous material. Also BFR/CFR/PVC Free
Solder Process Capability	Not reviewed for solder process capability

Product Compliance Disclaimer

This information is provided based on reasonable inquiry of our suppliers and represents our current actual knowledge based on the information they provided. This information is subject to change. The part numbers that TE has identified as EU RoHS compliant have a maximum concentration of 0.1% by weight in homogenous materials for lead, hexavalent chromium, mercury, PBB, PBDE, DBP, BBP, DEHP, DIBP, and 0.01% for cadmium, or qualify for an exemption to these limits as defined in the Annexes of Directive 2011/65/EU (RoHS2). Finished electrical and electronic equipment products will be CE marked as required by Directive 2011/65/EU. Components may not be CE marked. Additionally, the part numbers that TE has identified as EU ELV compliant have a maximum concentration of 0.1% by weight in homogenous materials for lead, hexavalent chromium, and mercury, and 0.01% for cadmium, or qualify for an exemption to these limits as defined in the Annexes of Directive 2000/53/EC (ELV). Regarding the REACH Regulation, the information TE provides on SVHC in articles for this part number is based on the latest European Chemicals Agency (ECHA) 'Guidance on requirements for substances in articles' posted at this URL: <https://echa.europa.eu/guidance-documents/guidance-on-reach>

Compatible Parts



TE Part # 170340-1
FF 250 TAB 20-14AWG BR WITHOUT LATCH



TE Part # 170341-3
FF 250 TAB 14-12AWG PTBR WITHOUT LATCH



TE Part # 170349-2
FF 250 TAB 22-20AWG TPBR WITHOUT LATCH



TE Part # 170340-3
FF 250 TAB 20-14AWG PTBR WITHOUT LATCH



TE Part # 170341-1
FF 250 TAB 14-12AWG BR WITHOUT LATCH



TE Part # 927357-2
FF 110 2P HOUSING PA66 BLACK



TE Part # 170349-1
FF 250 TAB 22-20AWG BR WITHOUT LATCH



TE Part # 2348943-1
FF 187&250 TAB HSG 9P NYLON NAT



TE Part # 927357-1
FF 110 2P HOUSING PA66 NATURAL



TE Part # 174198-1
FASTON .250 SERIES (6.3 MM) HOUSING

Also in the Series | FASTIN-FASTON 250

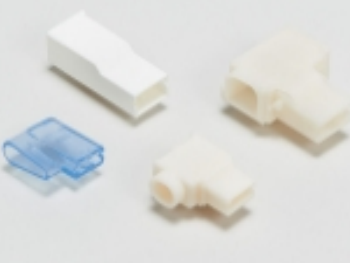

Crimp Terminal Housings(211)



Insertion & Extraction Tools(2)



PCB Terminals(2)



Quick Disconnects(254)

Customers Also Bought

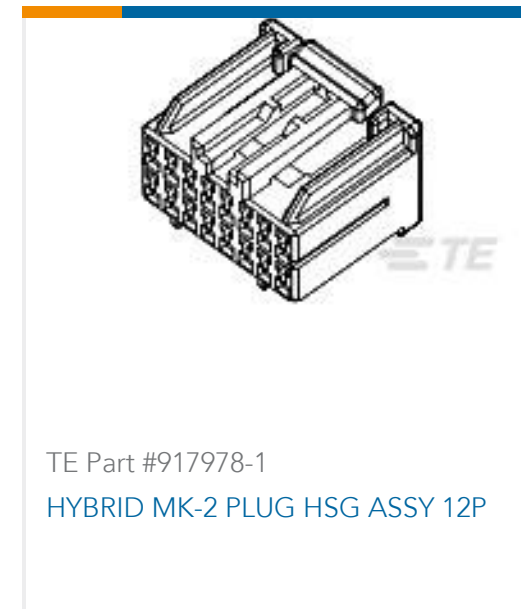
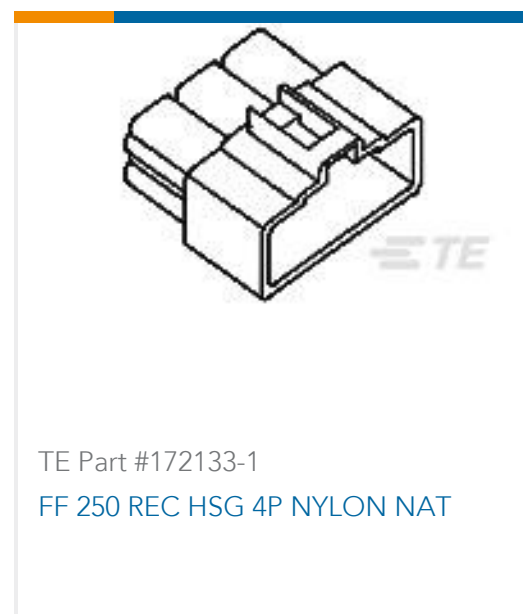

Documents

Product Drawings

FASTON .250 SERIES (6.3 MM) HOUSING

English

CAD Files

Customer View Model

[ENG_CVM_CVM_174197-1_O.2d_dxf.zip](#)

English

3D PDF

3D

Customer View Model

[ENG_CVM_CVM_174197-1_O.3d_igs.zip](#)

English

Customer View Model

[ENG_CVM_CVM_174197-1_O.3d_stp.zip](#)

English

By downloading the CAD file I accept and agree to the [Terms and Conditions](#) of use.

Agency Approvals



[CSA Certificate](#)

English

[CSA Certificate](#)

English