

General information

| | |
|-------------------|---------------------|
| Part number | K20KAC-P02LJG0-400S |
| Termination | solder |
| Size | 0 |
| Locking principle | break , push |
| Coding | a_key |
| Cable Diameter | cable_mini_40 |
| Cable outlet | bend_relief |

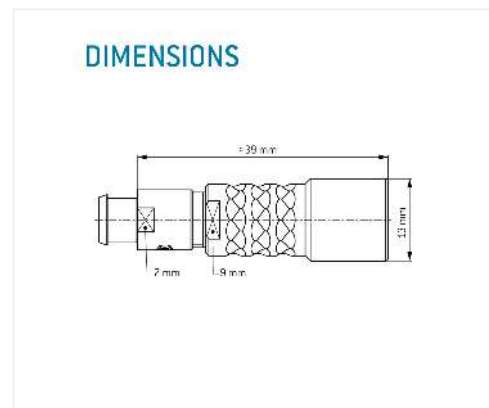

Contact insert description

| | |
|----------------------|---------|
| Number of contacts | 2 |
| Contact type | sockets |
| Contact diameter | 09mm |
| Insulator material | peek |
| Wire cross section | 22_awg |
| Termination | solder |
| Termination diameter | 085mm |

reverse_gender_on_request

Technical information

| | | |
|--|----------|---------------|
| Max. creepage and air clearance distance | 10_mm | 09_mm |
| Nominal current single contact | 075_a | iec_60512_5_2 |
| Nominal current insert | 7,5 A | vde_0298_4 |
| Test voltage | 15_kv_ac | sae_13441 |

safety_text

Mechanical and environmental data

| | |
|-----------------------|----------|
| Degree of protection* | ip68 |
| Operating temperature | 40_120_c |
| Mating cycles | 5000 |

mated

Material and surface treatments

| | |
|---------|---------------|
| Housing | m_chrome |
| Contact | cu_alloy_gold |

safety_text_2
ul_text
illustrative_text