

Single/One Axis Narrow Range Electrolytic Tilt Sensor

Part Number: 0711-0768-99 and 0719-1143-99

Operating Specifications

Operating range	±3°
Linear Range	±0.25°
Axes of Measurement	1
Repeatability	±0.0008° (±3")
Resolution	≤0.0003° (≤1")
Null Offset (PN 0719-3703-99 only)	±0.003° (±10")
Long Term Stability/Drift	±0.0008° (±3")
Operating Temperature	-20 °C to 50 °C
Storage Temperature	-55 °C to +125 °C
Null Impedance	14 kΩ
Null Temperature Coefficient	±0.0001° (±0.5") per °C
Time Constant (63.2% of final output)	≤500 ms
Materials	Non-magnetic
Maximum Current at Null	0.2 mA (continuous)

Physical Characteristics

0711-0768-99 (sensor)	
Length	32 mm (1.25")
Diameter	7.1 mm (0.281")
Lead Length	3.2 mm (0.125")
Weight	5 g

0719-1143-99 (encapsulated sensor)	
Length	41 mm (1.63")
Width	13 mm (0.50")
Height	15.9 mm (0.625")
Post Diameter	2.2 mm (0.086")
Post Height	9 mm (0.37")
Lead Length	381 mm (14.0")
Wire Gauge	30 AWG
Weight	20 g

Benefits

- Extremely high accuracy, resolution, and repeatability
- Very low power consumption
- Extremely long life
- Minimal drift over lifetime compared to MEMS devices
- Excellent customer support
- Manufactured in the United States of America

Functional Diagram

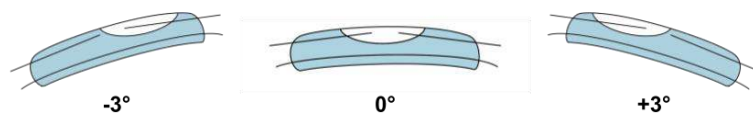

Description

The 0711-0768-99 and 0719-1143-99 single/one axis narrow-range electrolytic tilt sensor is a high accuracy solution for extremely high resolution and repeatability position measurements in one axis over an angle range of ±3°. This sensor can also be encapsulated (PN 0719-1143-99) to simplify integration into a larger system.

This is a passive sensor that requires signal conditioning electronics to provide an output. For a list of compatible signal conditioners, see the Related Products section on page 2.

Applications

- Geotechnical and geophysical monitoring
- Structural monitoring
- Tilt meters, tilt beams, and horizontal inclinometers
- Railway track monitoring
- Machine tool leveling
- Zero reference

View a full list of applications for our sensors on our website at www.frederickscompany.com.

Linear and Operating Range Behavior

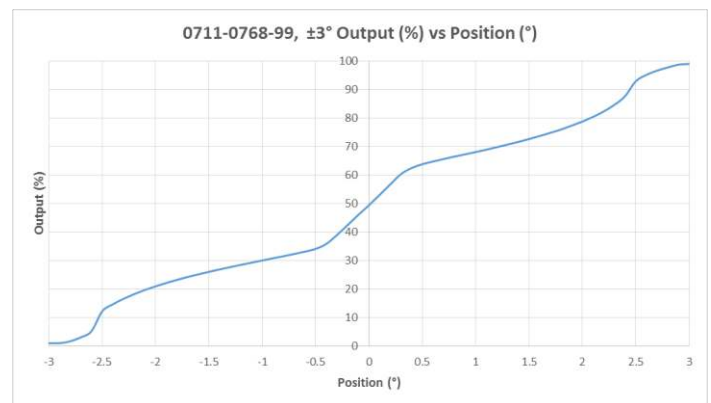



Single/One Axis Narrow Range Electrolytic Tilt Sensor

Part Number: 0711-0768-99 and 0719-1143-99

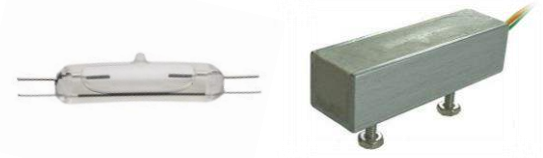

Certifications and Ratings

- RoHS Compliant

Notes

When using an excitation circuit not designed by The Fredericks Company, ensure that no direct current passes through the sensor. Direct current will lead to sensor damage, output drift, and general instability. For a description of hardware and software design for this sensor, see application note AN1000.

The 0711-0768-99 and 0719-1143-99 must be mounted horizontally (parallel to the surface of the earth and perpendicular to the force of gravity). For best performance, isolate the sensor from vibrations when mounting it.

Further information on electrolytic tilt sensor basics is provided on our website at www.frederickscompany.com.

Test Circuit

All data was acquired with a Fredericks Company Dual Axis 6200 Series Signal Conditioner in single axis mode at 20° C. A general schematic of our signal conditioners is provided below. Further information on sensor excitation and excitation circuitry is provided on The Fredericks Company website and in the application note AN1000.

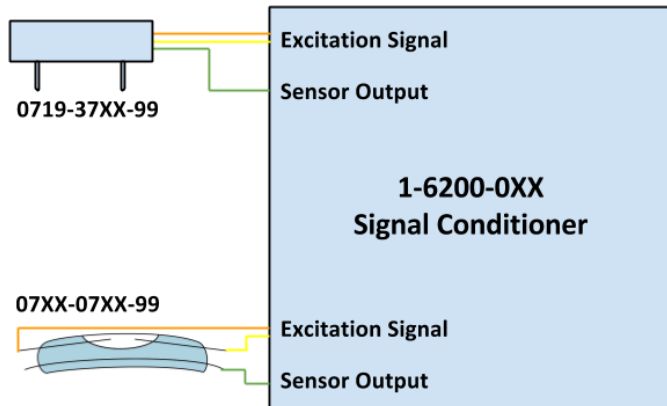

Dimensional Drawings

0711-0768-99

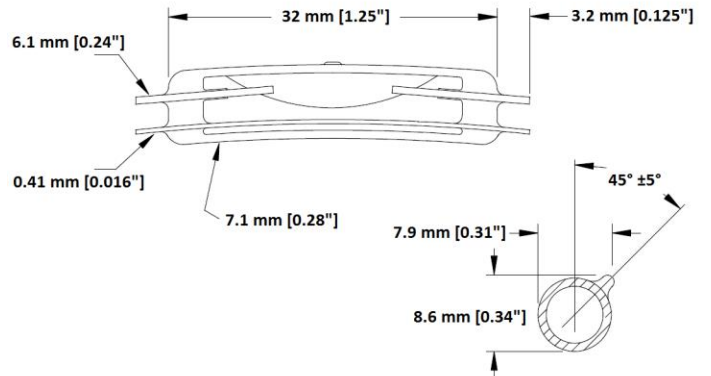

0719-1143-99

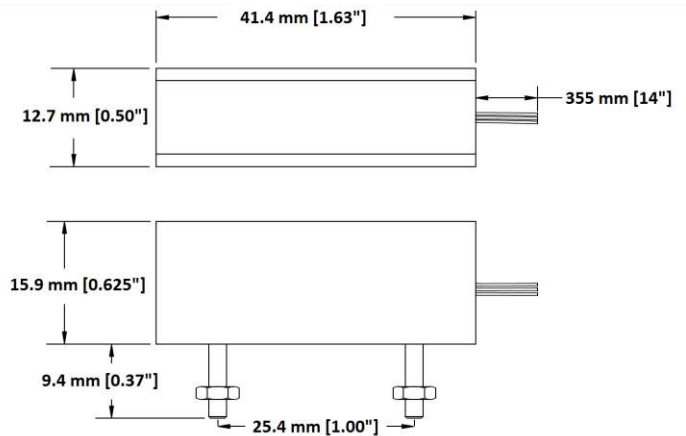

Related Products

Signal Conditioners (PCB, no sensors)

- 1-6200-005 SPI interface
- 1-6200-006 RS-232 interface
- 1-6200-007 Analog/PWM interface
- 1-6200-008 RS-485 interface
- 1-6200-012 Analog/RS-232 interface, high accuracy

Contact Us

The Fredericks Company
 2400 Philmont Avenue
 Huntingdon Valley, PA 19006
 tel: +1 215 947 2500
 fax: +1 215 947 7464
 email: sales@frederickscompany.com
 web: www.frederickscompany.com

Disclaimer: Specifications subject to change without notice. The Fredericks Company assumes no responsibility for inaccuracies in product specifications or any liability arising from product use. © 2017 The Fredericks Company

Visit our website at www.frederickscompany.com for a full list of products.