

FEATURES

High Accuracy, Supports 50 Hz/60 Hz IEC 687/1036
Less than 0.1% Error Over a Dynamic Range of 500 to 1

The AD7755 Supplies Average Real Power on the Frequency Outputs F1 and F2

The High Frequency Output CF Is Intended for Calibration and Supplies Instantaneous Real Power

The Logic Output REVP Can Be Used to Indicate a Potential Miswiring or Negative Power

Direct Drive for Electromechanical Counters and Two Phase Stepper Motors (F1 and F2)

A PGA in the Current Channel Allows the Use of Small Values of Shunt and Burden Resistance

Proprietary ADCs and DSP Provide High Accuracy over Large Variations in Environmental Conditions and Time

On-Chip Power Supply Monitoring

On-Chip Creep Protection (No Load Threshold)

On-Chip Reference 2.5 V 6 8% (30 ppm/8C Typical) with External Overdrive Capability

Single 5 V Supply, Low Power (15 mW Typical)

Low Cost CMOS Process

GENERAL DESCRIPTION

The AD7755 is a high accuracy electrical energy measurement IC. The part specifications surpass the accuracy requirements as quoted in the IEC1036 standard. See Analog Devices' Application Note AN-559 for a description of an IEC1036 watt-hour meter reference design.

The only analog circuitry used in the AD7755 is in the ADCs and reference circuit. All other signal processing (e.g., multiplication and filtering) is carried out in the digital domain. This approach provides superior stability and accuracy over extremes in environmental conditions and over time.

The AD7755 supplies average real power information on the low frequency outputs F1 and F2. These logic outputs may be used to directly drive an electromechanical counter or interface to an MCU. The CF logic output gives instantaneous real power information. This output is intended to be used for calibration purposes, or interfacing to an MCU.

The AD7755 includes a power supply monitoring circuit on the AV_{DD} supply pin. The AD7755 will remain in a reset condition until the supply voltage on AV_{DD} reaches 4 V. If the supply falls below 4 V, the AD7755 will also be reset and no pulses will be issued on F1, F2 and CF.

Internal phase matching circuitry ensures that the voltage and current channels are phase matched whether the HPF in Channel 1 is on or off. An internal no-load threshold ensures that the AD7755 does not exhibit any creep when there is no load.

The AD7755 is available in 24-lead DIP and SSOP packages.

FUNCTIONAL BLOCK DIAGRAM

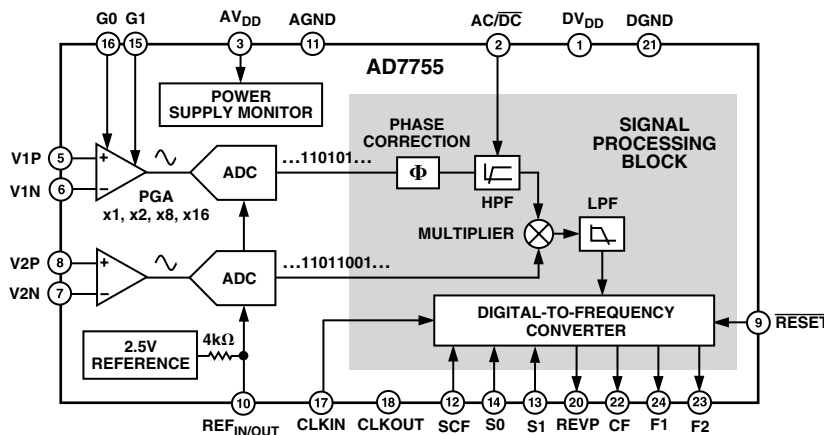

*U.S. Patents 5,745,323, 5,760,617, 5,862,069, 5,872,469.

REV. B

Information furnished by Analog Devices is believed to be accurate and reliable. However, no responsibility is assumed by Analog Devices for its use, nor for any infringements of patents or other rights of third parties which may result from its use. No license is granted by implication or otherwise under any patent or patent rights of Analog Devices.

AD7755—SPECIFICATIONS

($V_{DD} = DV_{DD} = 5\text{ V} \pm 5\%$, $AGND = DGND = 0\text{ V}$, On-Chip Reference, $CLKIN = 3.58\text{ MHz}$,
 T_{MIN} to $T_{MAX} = -40^{\circ}\text{C}$ to $+85^{\circ}\text{C}$)

Parameter	A Version	B Version	Unit	Test Conditions/Comments
ACCURACY^{1, 2}				
Measurement Error ¹ on Channel 1				Channel 2 with Full-Scale Signal ($\pm 660\text{ mV}$), 25°C
Gain = 1	0.1	0.1	% Reading typ	Over a Dynamic Range 500 to 1
Gain = 2	0.1	0.1	% Reading typ	Over a Dynamic Range 500 to 1
Gain = 8	0.1	0.1	% Reading typ	Over a Dynamic Range 500 to 1
Gain = 16	0.1	0.1	% Reading typ	Over a Dynamic Range 500 to 1
Phase Error ¹ Between Channels				Line Frequency = 45 Hz to 65 Hz
V1 Phase Lead 37° (PF = 0.8 Capacitive)	± 0.1	± 0.1	Degrees($^{\circ}$) max	$AC/\overline{DC} = 0$ and $AC/\overline{DC} = 1$
V1 Phase Lag 60° (PF = 0.5 Inductive)	± 0.1	± 0.1	Degrees($^{\circ}$) max	$AC/\overline{DC} = 0$ and $AC/\overline{DC} = 1$
AC Power Supply Rejection ¹				$AC/\overline{DC} = 1$, $S_0 = S_1 = 1$, $G_0 = G_1 = 0$
Output Frequency Variation (CF)	0.2	0.2	% Reading typ	V1 = 100 mV rms, V2 = 100 mV rms, @ 50 Hz Ripple on AV_{DD} of 200 mV rms @ 100 Hz
DC Power Supply Rejection ¹				$AC/\overline{DC} = 1$, $S_0 = S_1 = 1$, $G_0 = G_1 = 0$
Output Frequency Variation (CF)	± 0.3	± 0.3	% Reading typ	V1 = 100 mV rms, V2 = 100 mV rms, $AV_{DD} = DV_{DD} = 5\text{ V} \pm 250\text{ mV}$
ANALOG INPUTS				
Maximum Signal Levels	± 1	± 1	V max	See Analog Inputs Section
Input Impedance (DC)	390	390	k Ω min	V1P, V1N, V2N and V2P to AGND
Bandwidth (-3 dB)	14	14	kHz typ	CLKIN = 3.58 MHz
ADC Offset Error ^{1, 2}	± 25	± 25	mV max	CLKIN/256, CLKIN = 3.58 MHz
Gain Error ¹	± 7	± 7	% Ideal typ	Gain = 1, See Terminology and Performance Graphs
Gain Error Match ¹	± 0.2	± 0.2	% Ideal typ	External 2.5 V Reference, Gain = 1 V1 = 470 mV dc, V2 = 660 mV dc External 2.5 V Reference
REFERENCE INPUT				
REF _{IN/OUT} Input Voltage Range	2.7	2.7	V max	2.5 V + 8%
	2.3	2.3	V min	2.5 V - 8%
Input Impedance	3.2	3.2	k Ω min	
Input Capacitance	10	10	pF max	
ON-CHIP REFERENCE				
Reference Error	± 200	± 200	mV max	Nominal 2.5 V
Temperature Coefficient	± 30	± 30	ppm/ $^{\circ}\text{C}$ typ	
		± 60	ppm/ $^{\circ}\text{C}$ max	
CLKIN				
Input Clock Frequency	4	4	MHz max	Note All Specifications for CLKIN of 3.58 MHz
	1	1	MHz min	
LOGIC INPUTS³				
SCF, S0, S1, AC/\overline{DC} , $\overline{\text{RESET}}$, G0 and G1				
Input High Voltage, V_{INH}	2.4	2.4	V min	$DV_{DD} = 5\text{ V} \pm 5\%$
Input Low Voltage, V_{INL}	0.8	0.8	V max	$DV_{DD} = 5\text{ V} \pm 5\%$
Input Current, I_{IN}	± 3	± 3	μA max	Typically 10 nA, $V_{IN} = 0\text{ V}$ to DV_{DD}
Input Capacitance, C_{IN}	10	10	pF max	
LOGIC OUTPUTS³				
F1 and F2				
Output High Voltage, V_{OH}	4.5	4.5	V min	$I_{SOURCE} = 10\text{ mA}$ $DV_{DD} = 5\text{ V}$
Output Low Voltage, V_{OL}	0.5	0.5	V max	$I_{SINK} = 10\text{ mA}$ $DV_{DD} = 5\text{ V}$
CF and REVP				
Output High Voltage, V_{OH}	4	4	V min	$I_{SOURCE} = 5\text{ mA}$ $DV_{DD} = 5\text{ V}$
Output Low Voltage, V_{OL}	0.5	0.5	V max	$I_{SINK} = 5\text{ mA}$ $DV_{DD} = 5\text{ V}$

Parameter	A Version	B Version	Unit	Test Conditions/Comments
POWER SUPPLY				
AV_{DD}	4.75	4.75	V min	For Specified Performance 5 V - 5%
	5.25	5.25	V max	5 V + 5%
DV_{DD}	4.75	4.75	V min	5 V - 5%
	5.25	5.25	V max	5 V + 5%
AI_{DD}	3	3	mA max	Typically 2 mA
DI_{DD}	2.5	2.5	mA max	Typically 1.5 mA

NOTES

¹See Terminology section for explanation of specifications.

²See Plots in Typical Performance Graphs.

³Sample tested during initial release and after any redesign or process change that may affect this parameter.

Specifications subject to change without notice.

TIMING CHARACTERISTICS^{1, 2} ($AV_{DD} = DV_{DD} = 5 V \pm 5\%$, $AGND = DGND = 0 V$, On-Chip Reference, $CLKIN = 3.58 MHz$, T_{MIN} to $T_{MAX} = -40^{\circ}C$ to $+85^{\circ}C$)

Parameter	A/B Versions	Unit	Test Conditions/Comments
t_1 ³	275	ms	F1 and F2 Pulswidth (Logic Low)
t_2	See Table III	sec	Output Pulse Period. See Transfer Function Section
t_3	$1/2 t_2$	sec	Time Between F1 Falling Edge and F2 Falling Edge
t_4 ^{3, 4}	90	ms	CF Pulswidth (Logic High)
t_5	See Table IV	sec	CF Pulse Period. See Transfer Function Section
t_6	$CLKIN/4$	sec	Minimum Time Between F1 and F2 Pulse

NOTES

¹Sample tested during initial release and after any redesign or process change that may affect this parameter.

²See Figure 1.

³The pulswidths of F1, F2 and CF are not fixed for higher output frequencies. See Frequency Outputs Section.

⁴The CF pulse is always 18 μs in the high frequency mode. See Frequency Outputs section and Table IV.

Specifications subject to change without notice.

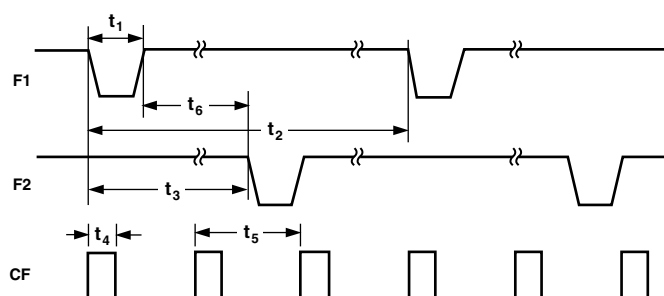

Figure 1. Timing Diagram for Frequency Outputs

ORDERING GUIDE

Model	Package Description	Package Options
AD7755AAN	Plastic DIP	N-24
AD7755AARS	Shrink Small Outline Package	RS-24
AD7755ABRS	Shrink Small Outline Package	RS-24
EVAL-AD7755EB	AD7755 Evaluation Board	
AD7755AAN-REF	AD7755 Reference Design PCB (See AN-559)	

AD7755

ABSOLUTE MAXIMUM RATINGS*

(T_A = +25°C unless otherwise noted)

AV _{DD} to AGND	−0.3 V to +7 V
DV _{DD} to DGND	−0.3 V to +7 V
DV _{DD} to AV _{DD}	−0.3 V to +0.3 V
Analog Input Voltage to AGND	
V1P, V1N, V2P and V2N	−6 V to +6 V
Reference Input Voltage to AGND	−0.3 V to AV _{DD} + 0.3 V
Digital Input Voltage to DGND	−0.3 V to DV _{DD} + 0.3 V
Digital Output Voltage to DGND	−0.3 V to DV _{DD} + 0.3 V
Operating Temperature Range	
Industrial (A, B Versions)	−40°C to +85°C
Storage Temperature Range	−65°C to +150°C
Junction Temperature	150°C

24-Lead Plastic DIP, Power Dissipation	450 mW
θ _{JA} Thermal Impedance	105°C/W
Lead Temperature, (Soldering 10 sec)	260°C
24-Lead SSOP, Power Dissipation	450 mW
θ _{JA} Thermal Impedance	112°C/W
Lead Temperature, Soldering	
Vapor Phase (60 sec)	215°C
Infrared (15 sec)	220°C

*Stresses above those listed under Absolute Maximum Ratings may cause permanent damage to the device. This is a stress rating only; functional operation of the device at these or any other conditions above those listed in the operational sections of this specification is not implied. Exposure to absolute maximum rating conditions for extended periods may affect device reliability.

CAUTION

ESD (electrostatic discharge) sensitive device. Electrostatic charges as high as 4000 V readily accumulate on the human body and test equipment and can discharge without detection. Although the AD7755 features proprietary ESD protection circuitry, permanent damage may occur on devices subjected to high-energy electrostatic discharges. Therefore, proper ESD precautions are recommended to avoid performance degradation or loss of functionality.



TERMINOLOGY

MEASUREMENT ERROR

The error associated with the energy measurement made by the AD7755 is defined by the following formula:

$$\text{Percentage Error} = \frac{\text{Energy Registered by the AD7755} - \text{True Energy}}{\text{True Energy}} \times 100\%$$

PHASE ERROR BETWEEN CHANNELS

The HPF (High Pass Filter) in Channel 1 has a phase lead response. To offset this phase response and equalize the phase response between channels, a phase correction network is also placed in Channel 1. The phase correction network matches the phase to within ±0.1° over a range of 45 Hz to 65 Hz and ±0.2° over a range 40 Hz to 1 kHz. See Figures 22 and 23.

POWER SUPPLY REJECTION

This quantifies the AD7755 measurement error as a percentage of reading when the power supplies are varied.

For the ac PSR measurement a reading at nominal supplies (5 V) is taken. A 200 mV rms/100 Hz signal is then introduced onto the supplies and a second reading obtained under the same input signal levels. Any error introduced is expressed as a percentage of reading—see Measurement Error definition.

For the dc PSR measurement a reading at nominal supplies (5 V) is taken. The supplies are then varied ±5% and a second reading is obtained with the same input signal levels. Any error introduced is again expressed as a percentage of reading.

ADC OFFSET ERROR

This refers to the dc offset associated with the analog inputs to the ADCs. It means that with the analog inputs connected to AGND, the ADCs still see a small dc signal (offset). The offset decreases with increasing gain in channel V1. This specification is measured at a gain of 1. At a gain of 16, the dc offset is typically less than 1 mV. However, when the HPF is switched on, the offset is removed from the current channel and the power calculation is not affected by this offset.

GAIN ERROR

The gain error of the AD7755 is defined as the difference between the measured output frequency (minus the offset) and the ideal output frequency. It is measured with a gain of 1 in channel V1. The difference is expressed as a percentage of the ideal frequency. The ideal frequency is obtained from the AD7755 transfer function—see Transfer Function section.

GAIN ERROR MATCH

The gain error match is defined as the gain error (minus the offset) obtained when switching between a gain of 1 and a gain of 2, 8, or 16. It is expressed as a percentage of the output frequency obtained under a gain of 1. This gives the gain error observed when the gain selection is changed from 1 to 2, 8 or 16.

PIN FUNCTION DESCRIPTIONS

Pin No.	Mnemonic	Description
1	DV _{DD}	Digital Power Supply. This pin provides the supply voltage for the digital circuitry in the AD7755. The supply voltage should be maintained at $5\text{ V} \pm 5\%$ for specified operation. This pin should be decoupled with a $10\ \mu\text{F}$ capacitor in parallel with a ceramic $100\ \text{nF}$ capacitor.
2	AC/ $\overline{\text{DC}}$	High Pass Filter Select. This logic input is used to enable the HPF in Channel 1 (the current channel). A logic one on this pin enables the HPF. The associated phase response of this filter has been internally compensated over a frequency range of $45\ \text{Hz}$ to $1\ \text{kHz}$. The HPF filter should be enabled in power metering applications.
3	AV _{DD}	Analog Power Supply. This pin provides the supply voltage for the analog circuitry in the AD7755. The supply should be maintained at $5\text{ V} \pm 5\%$ for specified operation. Every effort should be made to minimize power supply ripple and noise at this pin by the use of proper decoupling. This pin should be decoupled to AGND with a $10\ \mu\text{F}$ capacitor in parallel with a ceramic $100\ \text{nF}$ capacitor.
4, 19 5, 6	NC V1P, V1N	No Connect. Analog Inputs for Channel 1 (Current Channel). These inputs are fully differential voltage inputs with a maximum differential signal level of $\pm 470\ \text{mV}$ for specified operation. Channel 1 also has a PGA and the gain selections are outlined in Table I. The maximum signal level at these pins is $\pm 1\ \text{V}$ with respect to AGND. Both inputs have internal ESD protection circuitry and in addition an overvoltage of $\pm 6\ \text{V}$ can be sustained on these inputs without risk of permanent damage.
7, 8	V2N, V2P	Negative and Positive Inputs for Channel 2 (Voltage Channel). These inputs provide a fully differential input pair. The maximum differential input voltage is $\pm 660\ \text{mV}$ for specified operation. The maximum signal level at these pins is $\pm 1\ \text{V}$ with respect to AGND. Both inputs have internal ESD protection circuitry and an overvoltage of $\pm 6\ \text{V}$ can also be sustained on these inputs without risk of permanent damage.
9	$\overline{\text{RESET}}$	Reset Pin for the AD7755. A logic low on this pin will hold the ADCs and digital circuitry in a reset condition. Bringing this pin logic low will clear the AD7755 internal registers.
10	REF _{IN/OUT}	This pin provides access to the on-chip voltage reference. The on-chip reference has a nominal value of $2.5\ \text{V} \pm 8\%$ and a typical temperature coefficient of $30\ \text{ppm}/^\circ\text{C}$. An external reference source may also be connected at this pin. In either case this pin should be decoupled to AGND with a $1\ \mu\text{F}$ ceramic capacitor and $100\ \text{nF}$ ceramic capacitor.
11	AGND	This provides the ground reference for the analog circuitry in the AD7755, i.e., ADCs and reference. This pin should be tied to the analog ground plane of the PCB. The analog ground plane is the ground reference for all analog circuitry, e.g., antialiasing filters, current and voltage transducers, etc. For good noise suppression the analog ground plane should only connected to the digital ground plane at one point. A star ground configuration will help to keep noisy digital currents away from the analog circuits.
12	SCF	Select Calibration Frequency. This logic input is used to select the frequency on the calibration output CF. Table IV shows how the calibration frequencies are selected.
13, 14	S1, S0	These logic inputs are used to select one of four possible frequencies for the digital-to-frequency conversion. This offers the designer greater flexibility when designing the energy meter. See Selecting a Frequency for an Energy Meter Application section.
15, 16	G1, G0	These logic inputs are used to select one of four possible gains for Channel 1, i.e., V1. The possible gains are 1, 2, 8 and 16. See Analog Input section.
17	CLKIN	An external clock can be provided at this logic input. Alternatively, a parallel resonant AT crystal can be connected across CLKIN and CLKOUT to provide a clock source for the AD7755. The clock frequency for specified operation is $3.579545\ \text{MHz}$. Crystal load capacitance of between $22\ \text{pF}$ and $33\ \text{pF}$ (ceramic) should be used with the gate oscillator circuit.
18	CLKOUT	A crystal can be connected across this pin and CLKIN as described above to provide a clock source for the AD7755. The CLKOUT pin can drive one CMOS load when an external clock is supplied at CLKIN or by the gate oscillator circuit.
20	REVP	This logic output will go logic high when negative power is detected, i.e., when the phase angle between the voltage and current signals is greater than 90° . This output is not latched and will be reset when positive power is once again detected. The output will go high or low at the same time as a pulse is issued on CF.

AD7755

Pin No.	Mnemonic	Description
21	DGND	This provides the ground reference for the digital circuitry in the AD7755, i.e., multiplier, filters and digital-to-frequency converter. This pin should be tied to the analog ground plane of the PCB. The digital ground plane is the ground reference for all digital circuitry, e.g., counters (mechanical and digital), MCUs and indicator LEDs. For good noise suppression the analog ground plane should only be connected to the digital ground plane at one point only, e.g., a star ground.
22	CF	Calibration Frequency Logic Output. The CF logic output gives instantaneous real power information. This output is intended to be used for calibration purposes. Also see SCF pin description.
23, 24	F2, F1	Low Frequency Logic Outputs. F1 and F2 supply <i>average real power</i> information. The logic outputs can be used to directly drive electromechanical counters and two phase stepper motors. See Transfer Function section.

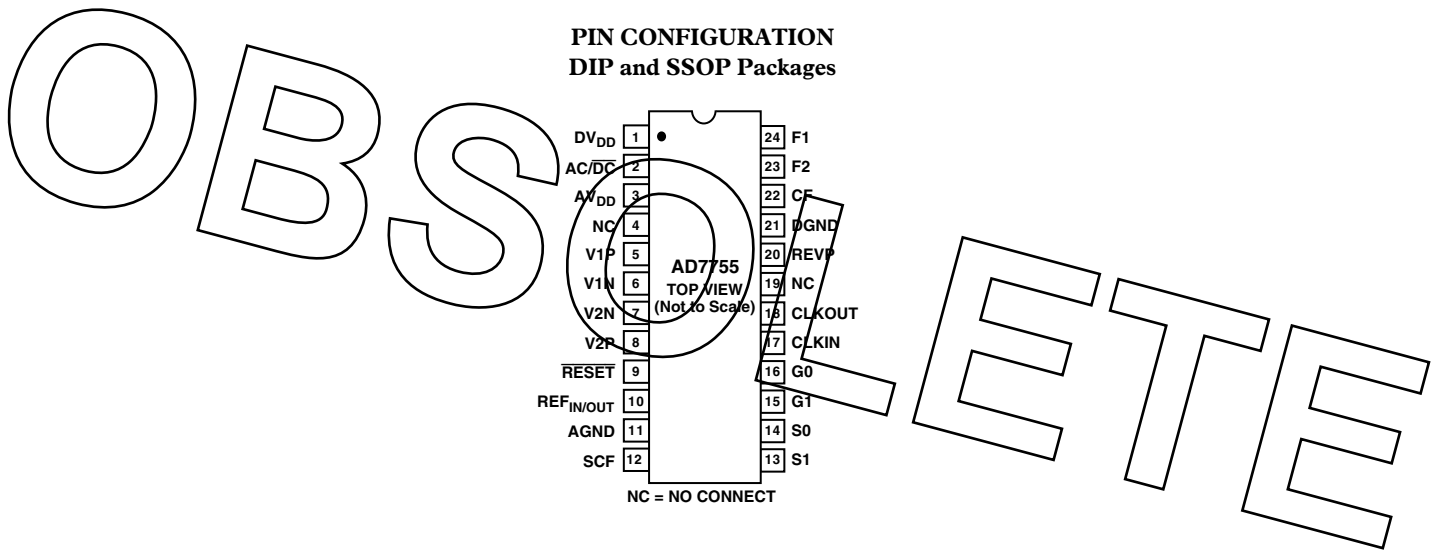

Typical Performance Characteristics—AD7755

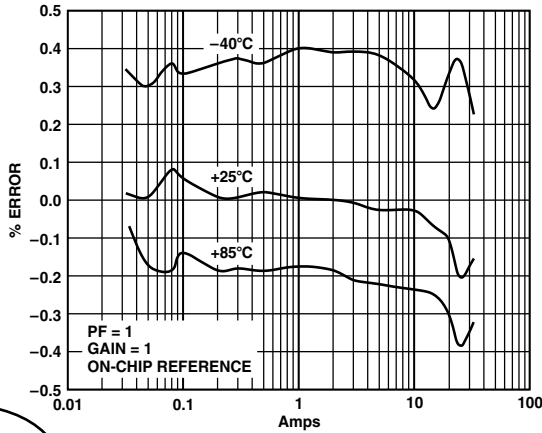

Figure 2. Error as a % of Reading (Gain = 1)

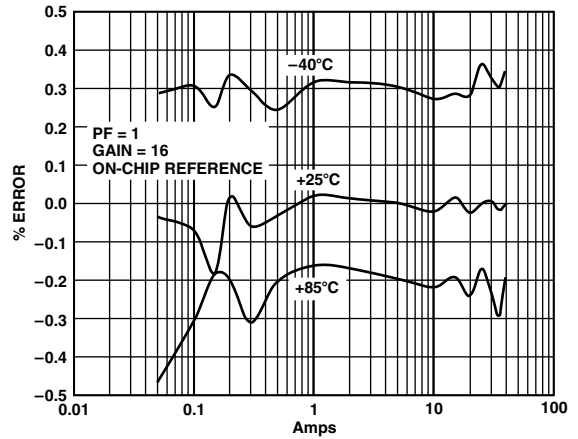

Figure 5. Error as a % of Reading (Gain = 16)

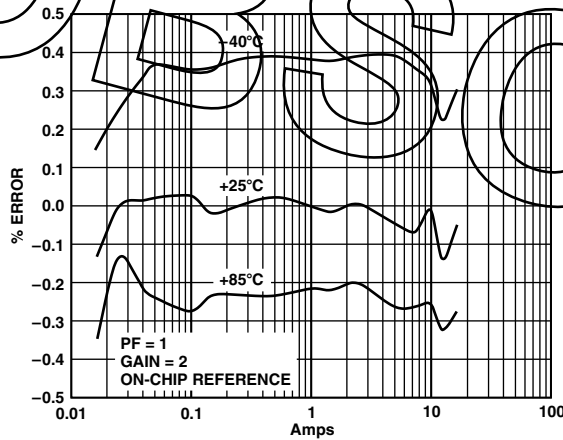

Figure 3. Error as a % of Reading (Gain = 2)

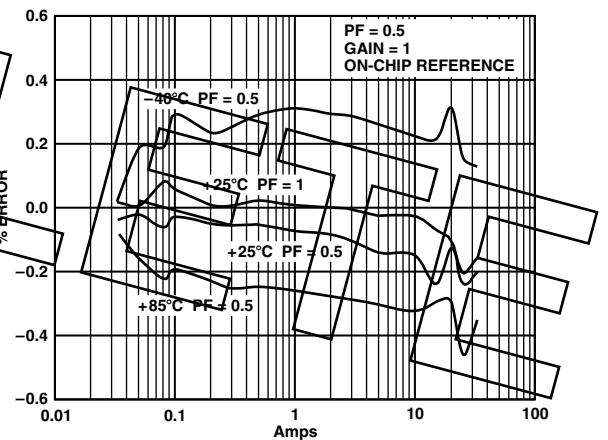

Figure 6. Error as a % of Reading (Gain = 1)

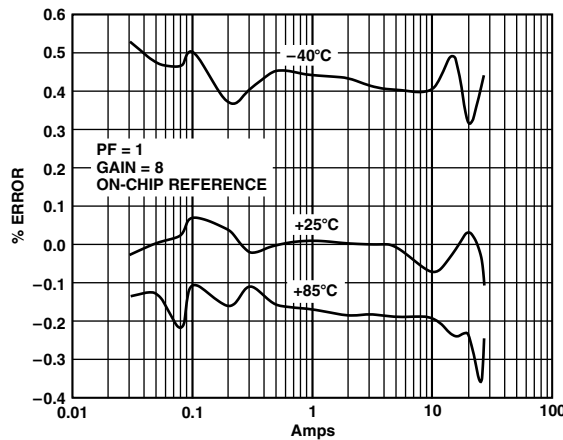

Figure 4. Error as a % of Reading (Gain = 8)

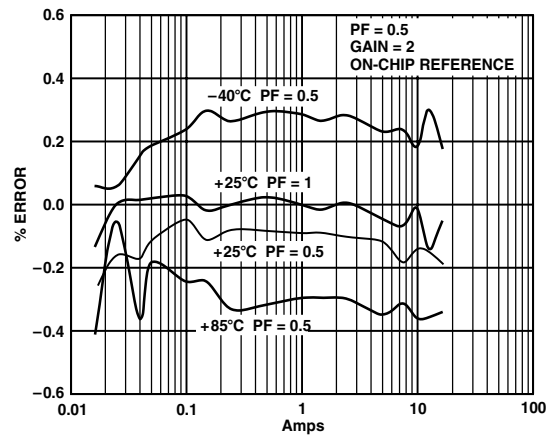

Figure 7. Error as a % of Reading (Gain = 2)

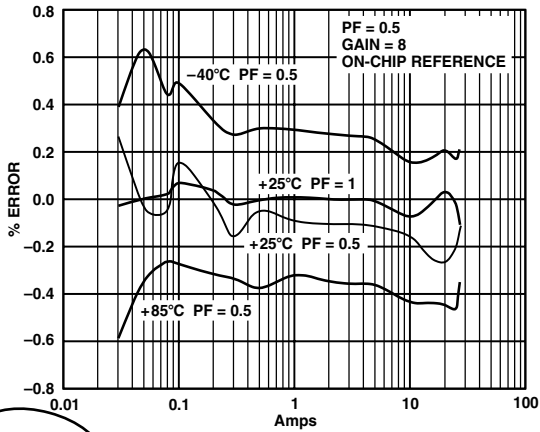

Figure 8. Error as a % of Reading (Gain = 8)

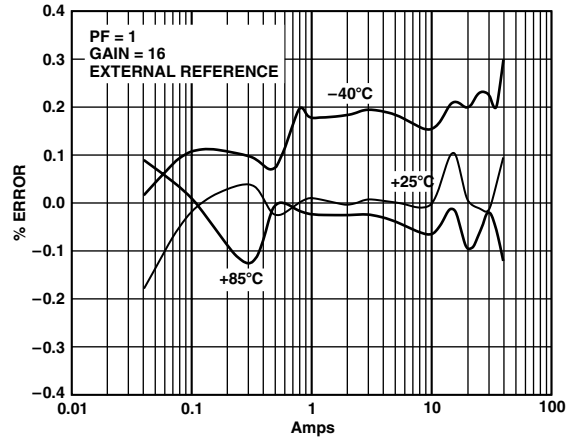

Figure 11. Error as a % of Reading over Temperature with an External Reference (Gain = 16)

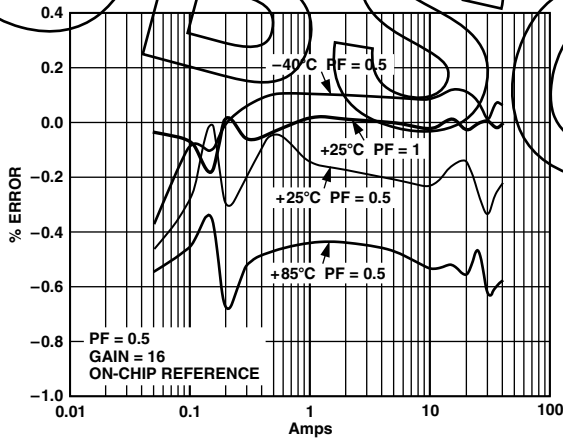

Figure 9. Error as a % of Reading (Gain = 16)

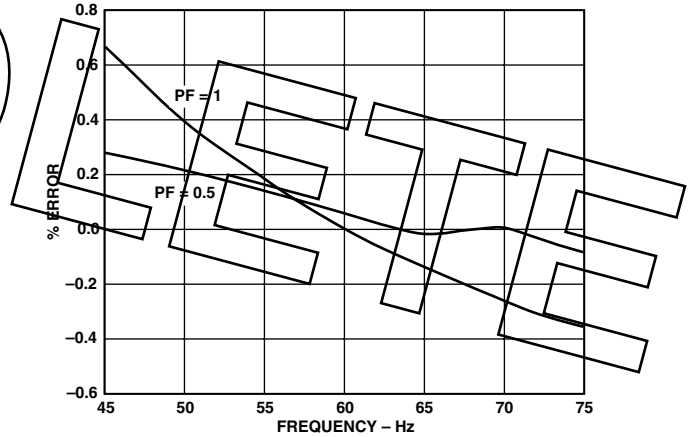

Figure 12. Error as a % of Reading over Frequency

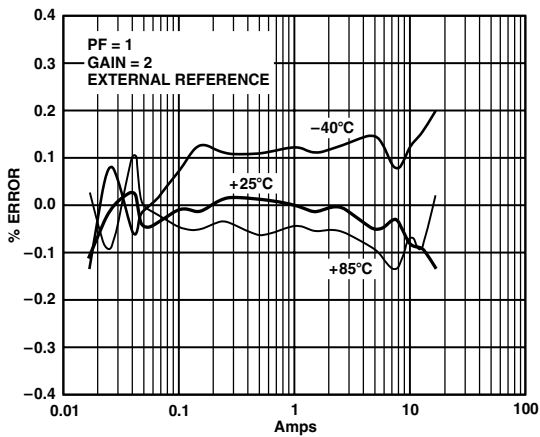

Figure 10. Error as a % of Reading over Temperature with an External Reference (Gain = 2)

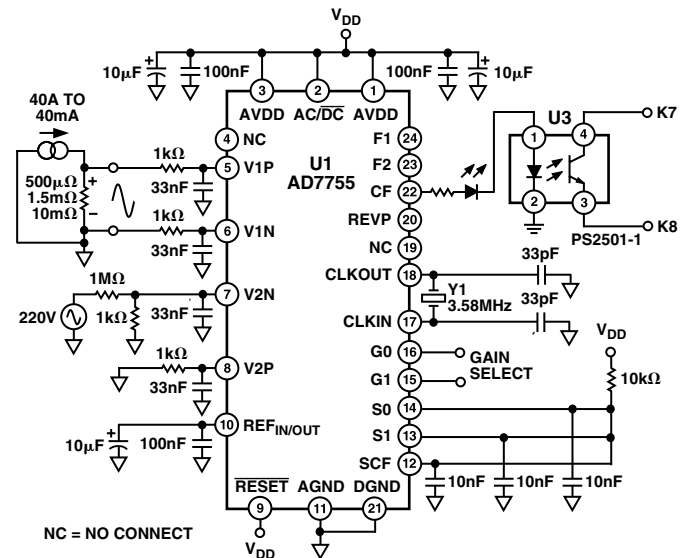

Figure 13. Test Circuit for Performance Curves

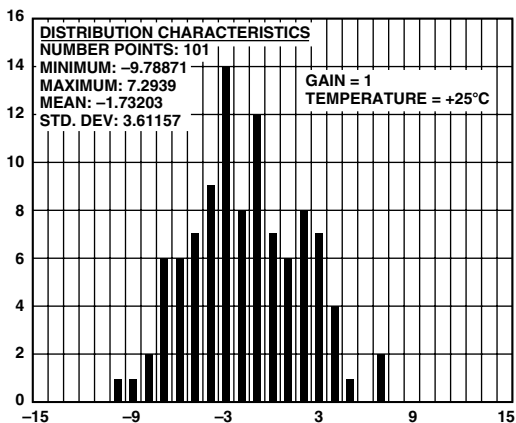

Figure 14. Channel 1 Offset Distribution (Gain = 1)

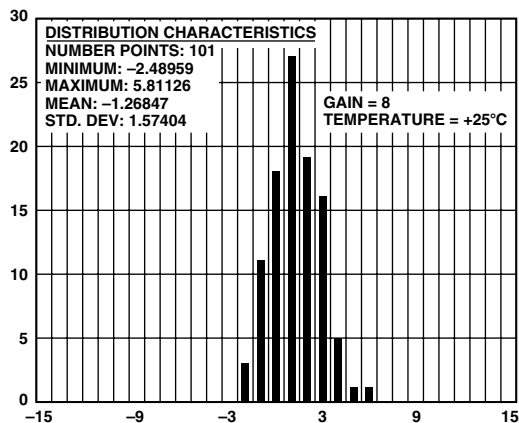

Figure 17. Channel 1 Offset Distribution (Gain = 8)

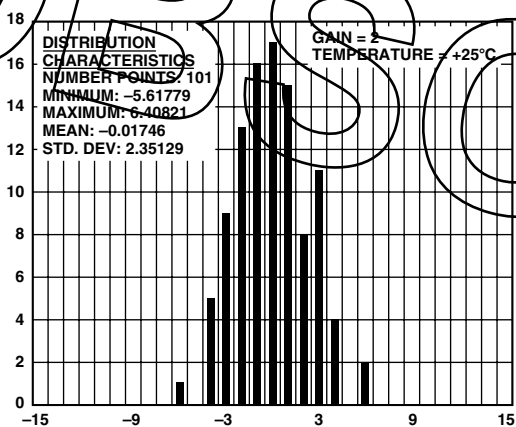

Figure 15. Channel 1 Offset Distribution (Gain = 2)

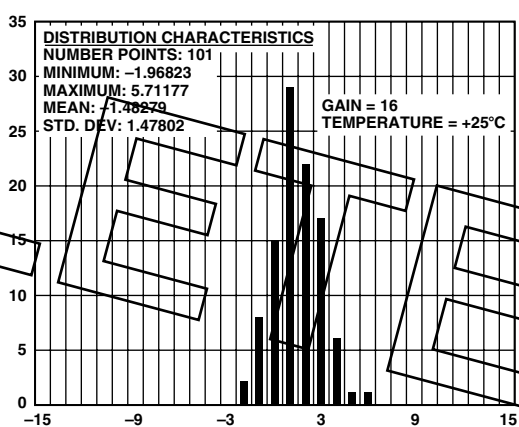

Figure 18. Channel 1 Offset Distribution (Gain = 16)

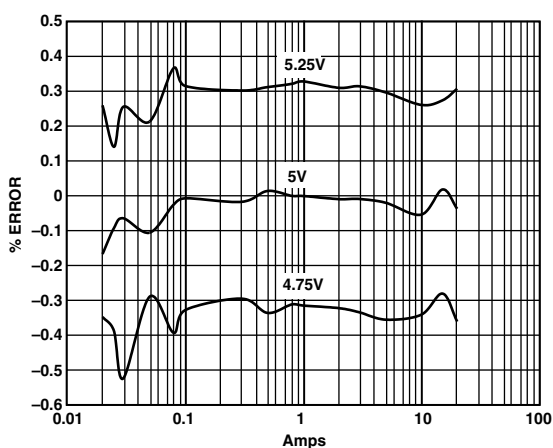

Figure 16. PSR with Internal Reference (Gain = 16)

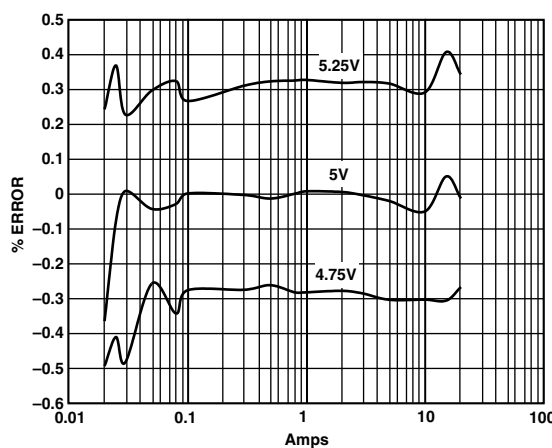

Figure 19. PSR with External Reference (Gain = 16)

AD7755

THEORY OF OPERATION

The two ADCs digitize the voltage signals from the current and voltage transducers. These ADCs are 16-bit second order sigma-delta with an oversampling rate of 900 kHz. This analog input structure greatly simplifies transducer interfacing by providing a wide dynamic range for direct connection to the transducer and also simplifying the antialiasing filter design. A programmable gain stage in the current channel further facilitates easy transducer interfacing. A high pass filter in the current channel removes any dc component from the current signal. This eliminates any inaccuracies in the real power calculation due to offsets in the voltage or current signals—see HPF and Offset Effects section.

The real power calculation is derived from the instantaneous power signal. The instantaneous power signal is generated by a direct multiplication of the current and voltage signals. In order to extract the real power component (i.e., the dc component), the instantaneous power signal is low-pass filtered. Figure 20 illustrates the instantaneous real power signal and shows how the real power information can be extracted by low-pass filtering the instantaneous power signal. This scheme correctly calculates real power for nonsinusoidal current and voltage waveforms at all power factors. All signal processing is carried out in the digital domain for superior stability over temperature and time.

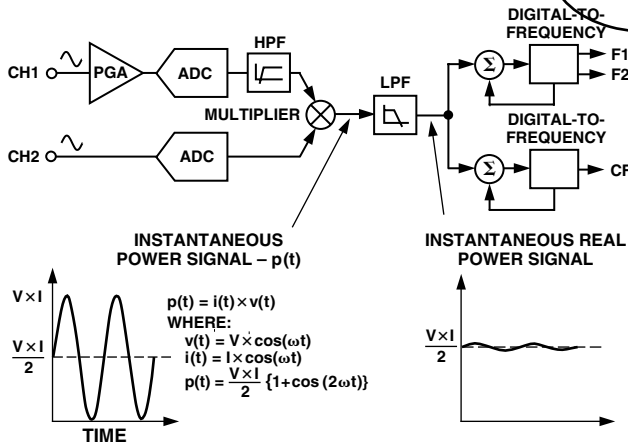

Figure 20. Signal Processing Block Diagram

The low frequency output of the AD7755 is generated by accumulating this real power information. This low frequency inherently means a long accumulation time between output pulses. The output frequency is therefore proportional to the average real power. This average real power information can, in turn, be accumulated (e.g., by a counter) to generate real energy information. Because of its high output frequency and hence shorter integration time, the CF output is proportional to the instantaneous real power. This is useful for system calibration purposes that would take place under steady load conditions.

Power Factor Considerations

The method used to extract the real power information from the instantaneous power signal (i.e., by low-pass filtering) is still valid even when the voltage and current signals are not in phase. Figure 21 displays the unity power factor condition and a DPF (Displacement Power Factor) = 0.5, i.e., current signal lagging

the voltage by 60°. If we assume the voltage and current waveforms are sinusoidal, the real power component of the instantaneous power signal (i.e., the dc term) is given by

$$\left(\frac{V \times I}{2}\right) \times \cos(60^\circ).$$

This is the correct real power calculation.

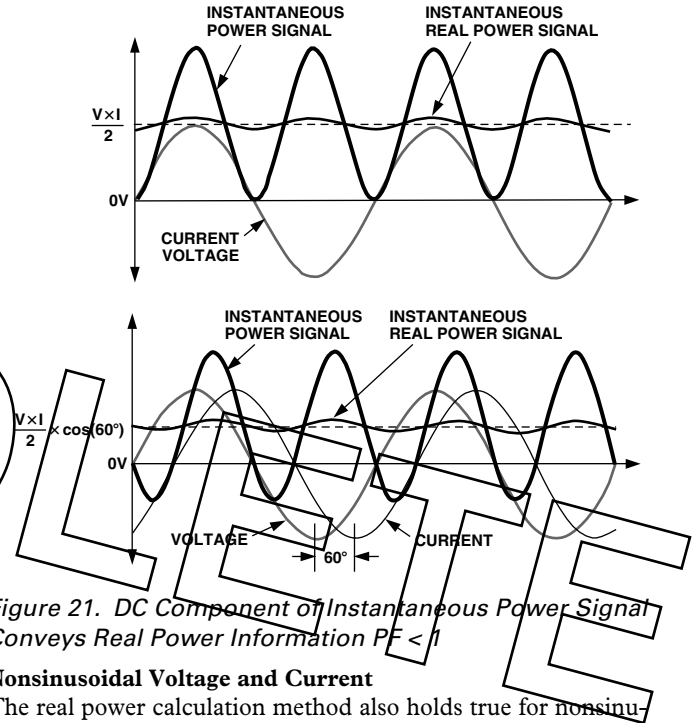

Figure 21. DC Component of Instantaneous Power Signal Conveys Real Power Information PF < 1

Nonsinusoidal Voltage and Current

The real power calculation method also holds true for nonsinusoidal current and voltage waveforms. All voltage and current waveforms in practical applications will have some harmonic content. Using the Fourier Transform, instantaneous voltage and current waveforms can be expressed in terms of their harmonic content.

$$v(t) = V_0 + \sqrt{2} \times \sum_{h \neq 0} V_h \times \sin(h\omega t + \alpha_h) \tag{1}$$

where:

- $v(t)$ is the instantaneous voltage
- V_0 is the average value
- V_h is the rms value of voltage harmonic h
- and
- α_h is the phase angle of the voltage harmonic.

$$i(t) = I_0 + \sqrt{2} \times \sum_{h \neq 0} I_h \times \sin(h\omega t + \beta_h) \tag{2}$$

where:

- $i(t)$ is the instantaneous current
- I_0 is the dc component
- I_h is the rms value of current harmonic h
- and
- β_h is the phase angle of the current harmonic.

Using Equations 1 and 2, the real power P can be expressed in terms of its fundamental real power (P_1) and harmonic real power (P_H).

$$P = P_1 + P_H$$

where:

$$P_1 = V_1 \times I_1 \cos \phi_1$$

$$\phi_1 = \alpha_1 - \beta_1$$

(3)

and

$$P_H = \sum_{h \neq 1}^{\infty} V_h \times I_h \cos \phi_h$$

(4)

$$\phi_h = \alpha_h - \beta_h$$

As can be seen from Equation 4 above, a harmonic real power component is generated for every harmonic, provided that harmonic is present in both the voltage and current waveforms.

The power factor calculation has previously been shown to be accurate in the case of a pure sinusoid, therefore the harmonic real power must also correctly account for power factor since it is made up of a series of pure sinusoids.

Note that the input bandwidth of the analog inputs is 14 kHz with a master clock frequency of 3.5795 MHz.

ANALOG INPUTS

Channel V1 (Current Channel)

The voltage output from the current transducer is connected to the AD7755 here. Channel V1 is a fully differential voltage input. V1P is the positive input with respect to V1N.

The maximum peak differential signal on Channel 1 should be less than ± 470 mV (330 mV rms for a pure sinusoidal signal) for specified operation. Note that Channel 1 has a programmable gain amplifier (PGA) with user selectable gain of 1, 2, 8 or 16 (see Table I). These gains facilitate easy transducer interfacing.

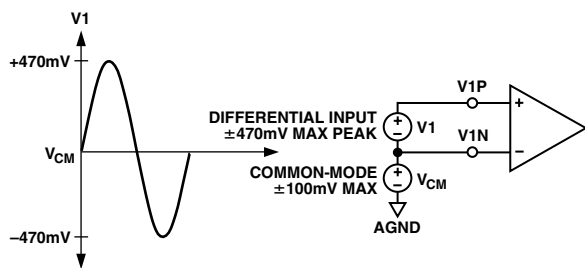

Figure 22. Maximum Signal Levels, Channel 1, Gain = 1

The diagram in Figure 22 illustrates the maximum signal levels on V1P and V1N. The maximum differential voltage is ± 470 mV divided by the gain selection. The differential voltage signal on the inputs must be referenced to a common mode, e.g. AGND. The maximum common mode signal is ± 100 mV as shown in Figure 22.

Table I. Gain Selection for Channel 1

G1	G0	Gain	Maximum Differential Signal
0	0	1	± 470 mV
0	1	2	± 235 mV
1	0	8	± 60 mV
1	1	16	± 30 mV

Channel V2 (Voltage Channel)

The output of the line voltage transducer is connected to the AD7755 at this analog input. Channel V2 is a fully differential voltage input. The maximum peak differential signal on Channel 2 is ± 660 mV. Figure 23 illustrates the maximum signal levels that can be connected to the AD7755 Channel 2.

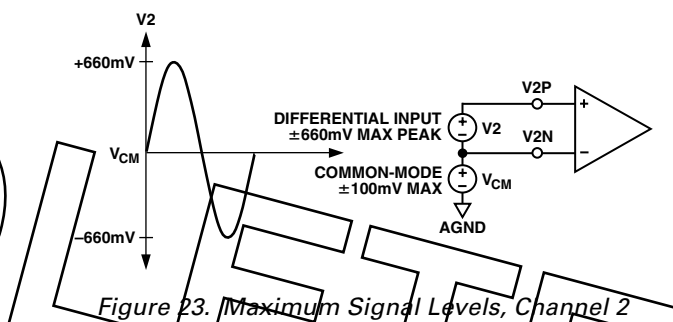

Figure 23. Maximum Signal Levels, Channel 2

Channel 2 must be driven from a common-mode voltage, i.e., the differential voltage signal on the input must be referenced to a common mode (usually AGND). The analog inputs of the AD7755 can be driven with common-mode voltages of up to 100 mV with respect to AGND. However best results are achieved using a common mode equal to AGND.

Typical Connection Diagrams

Figure 24 shows a typical connection diagram for Channel V1. A CT (current transformer) is the current transducer selected for this example. Notice the common-mode voltage for Channel 1 is AGND and is derived by center tapping the burden resistor to AGND. This provides the complementary analog input signals for V1P and V1N. The CT turns ratio and burden resistor R_b are selected to give a peak differential voltage of ± 470 mV/Gain at maximum load.

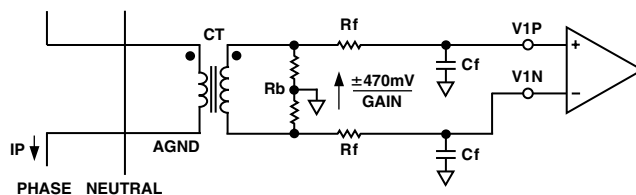

Figure 24. Typical Connection for Channel 1

AD7755

Figure 25 shows two typical connections for Channel V2. The first option uses a PT (potential transformer) to provide complete isolation from the mains voltage. In the second option the AD7755 is biased around the neutral wire, and a resistor divider is used to provide a voltage signal that is proportional to the line voltage. Adjusting the ratio of Ra, Rb and VR is also a convenient way of carrying out a gain calibration on the meter.

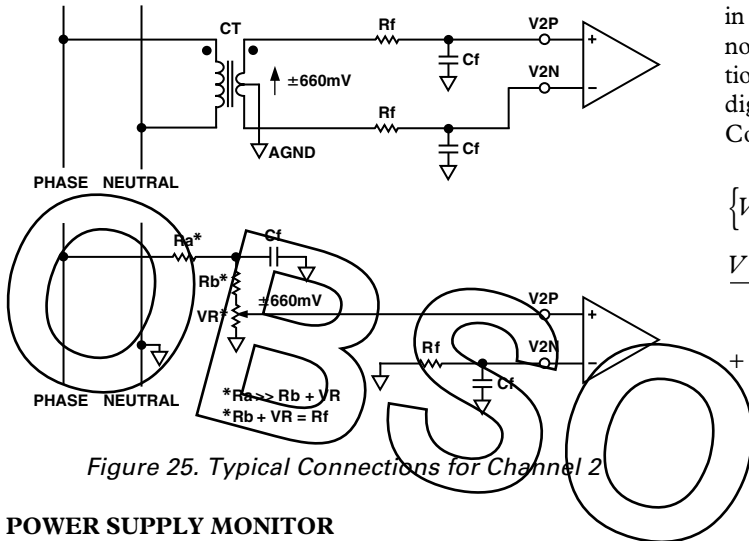

Figure 25. Typical Connections for Channel 2

POWER SUPPLY MONITOR

The AD7755 contains an on-chip power supply monitor. The Analog Supply (AV_{DD}) is continuously monitored by the AD7755. If the supply is less than 4 V ± 5%, the AD7755 will be reset. This is useful to ensure correct device start-up at power-up and power-down. The power supply monitor has built in hysteresis and filtering. This gives a high degree of immunity to false triggering due to noisy supplies.

As can be seen from Figure 26, the trigger level is nominally set at 4 V. The tolerance on this trigger level is about ±5%. The power supply and decoupling for the part should be such that the ripple at AV_{DD} does not exceed 5 V ± 5% as specified for normal operation.

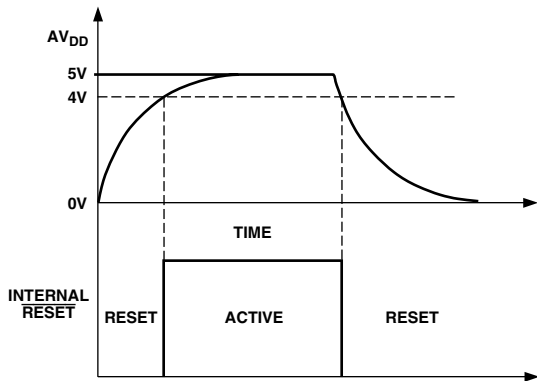

Figure 26. On-Chip Power Supply Monitor

HPF and Offset Effects

Figure 27 shows the effect of offsets on the real power calculation. As can be seen, an offset on Channel 1 and Channel 2 will contribute a dc component after multiplication. Since this dc component is extracted by the LPF and used to generate the real power information, the offsets will have contributed a constant error to the real power calculation. This problem is easily avoided by enabling the HPF (i.e., pin AC/DC is set logic high) in Channel 1. By removing the offset from at least one channel, no error component can be generated at dc by the multiplication. Error terms at cos(ωt) are removed by the LPF and the digital-to-frequency conversion—see Digital-to-Frequency Conversion section.

$$\{V \cos(\omega t) + V_{OS}\} \times \{I \cos(\omega t) + I_{OS}\} =$$

$$\frac{V \times I}{2} + V_{OS} \times I_{OS} + V_{OS} \times I \cos(\omega t) + I_{OS} \times V \cos(\omega t)$$

$$+ \frac{V \times I}{2} \times \cos(2\omega t)$$

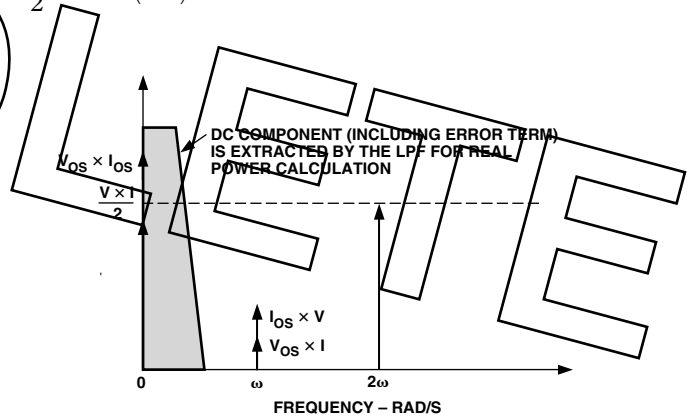

Figure 27. Effect of Channel Offset on the Real Power Calculation

The HPF in Channel 1 has an associated phase response that is compensated for on-chip. The phase compensation is activated when the HPF is enabled and is disabled when the HPF is not activated. Figures 28 and 29 show the phase error between channels with the compensation network activated. The AD7755 is phase compensated up to 1 kHz as shown. This will ensure correct active harmonic power calculation even at low power factors.

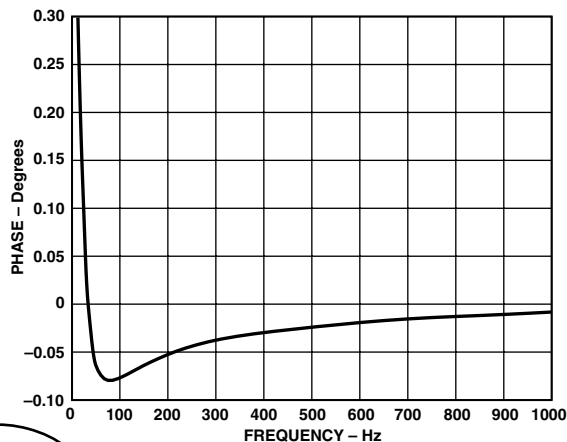

Figure 28. Phase Error Between Channels (0 Hz to 1 kHz)

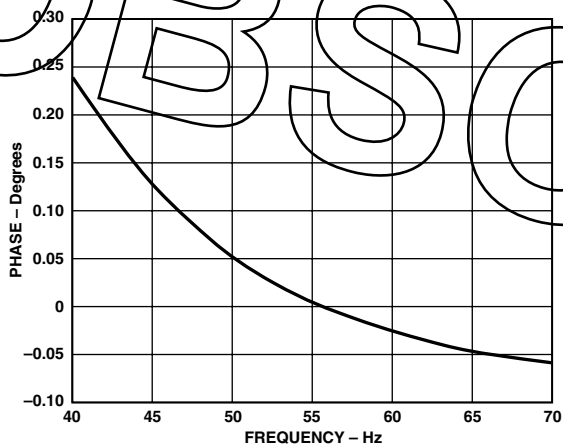

Figure 29. Phase Error Between Channels (40 Hz to 70 Hz)

DIGITAL-TO-FREQUENCY CONVERSION

As previously described, the digital output of the low-pass filter after multiplication contains the real power information. However since this LPF is not an ideal “brick wall” filter implementation, the output signal also contains attenuated components at the line frequency and its harmonics, i.e., $\cos(h\omega t)$ where $h = 1, 2, 3, \dots$ etc.

The magnitude response of the filter is given by:

$$|H(f)| = \frac{1}{1 + (f / 8.9 \text{ Hz})} \tag{5}$$

For a line frequency of 50 Hz this would give an attenuation of the 2ω (100 Hz) component of approximately -22 dBs. The dominating harmonic will be at twice the line frequency, i.e., $\cos(2\omega t)$ and this is due to the instantaneous power signal.

Figure 30 shows the instantaneous real power signal at the output of the CPF which still contains a significant amount of instantaneous power information, i.e., $\cos(2\omega t)$. This signal is then passed to the digital-to-frequency converter where it is integrated (accumulated) over time in order to produce an output frequency. This accumulation of the signal will suppress or average out any non-dc components in the instantaneous real power signal. The average value of a sinusoidal signal is zero. Hence the frequency generated by the AD7755 is proportional to the average real power. Figure 30 shows the digital-to-frequency conversion for steady load conditions, i.e., constant voltage and current.

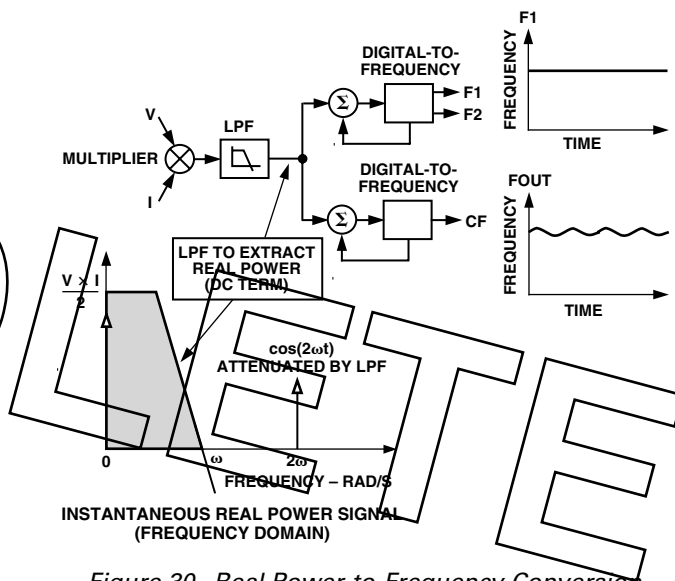

Figure 30. Real Power-to-Frequency Conversion

As can be seen in the diagram, the frequency output CF is seen to vary over time, even under steady load conditions. This frequency variation is primarily due to the $\cos(2\omega t)$ component in the instantaneous real power signal. The output frequency on CF can be up to 2048 times higher than the frequency on F1 and F2. This higher output frequency is generated by accumulating the instantaneous real power signal over a much shorter time while converting it to a frequency. This shorter accumulation period means less averaging of the $\cos(2\omega t)$ component. As a consequence, some of this instantaneous power signal passes through the digital-to-frequency conversion. This will not be a problem in the application. Where CF is used for calibration purposes, the frequency should be averaged by the frequency counter. This will remove any ripple. If CF is being used to measure energy, e.g., in a microprocessor-based application, the CF output should also be averaged to calculate power. Because the outputs F1 and F2 operate at a much lower frequency, a lot more averaging of the instantaneous real power signal is carried out. The result is a greatly attenuated sinusoidal content and a virtually ripple-free frequency output.

AD7755

Interfacing the AD7755 to a Microcontroller for Energy Measurement

The easiest way to interface the AD7755 to a microcontroller is to use the CF high frequency output with the output frequency scaling set to $2048 \times F_1, F_2$. This is done by setting $SCF = 0$ and $S_0 = S_1 = 1$, see Table IV. With full-scale ac signals on the analog inputs, the output frequency on CF will be approximately 5.5 kHz. Figure 31 illustrates one scheme which could be used to digitize the output frequency and carry out the necessary averaging mentioned in the previous section.

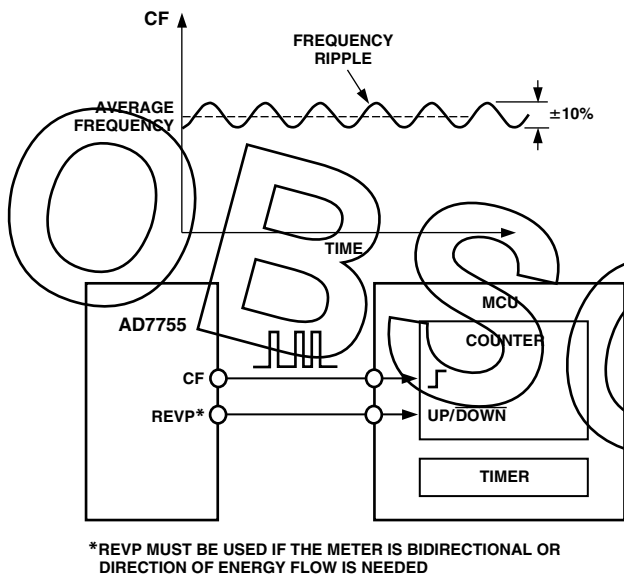

Figure 31. Interfacing the AD7755 to an MCU

As shown, the frequency output CF is connected to an MCU counter or port. This will count the number of pulses in a given integration time which is determined by an MCU internal timer. The average power is proportional to the average frequency is given by:

$$\text{Average Frequency} = \text{Average Real Power} = \frac{\text{Counter}}{\text{Timer}}$$

The energy consumed during an integration period is given by:

$$\text{Energy} = \text{Average Power} \times \text{Time} = \frac{\text{Counter}}{\text{Time}} \times \text{Time} = \text{Counter}$$

For the purpose of calibration, this integration time could be 10 to 20 seconds in order to accumulate enough pulses to ensure correct averaging of the frequency. In normal operation the integration time could be reduced to one or two seconds depending, for example, on the required update rate of a display. With shorter integration times on the MCU the amount of energy in each update may still have some small amount of ripple, even under steady load conditions. However, over a minute or more the measured energy will have no ripple.

Power Measurement Considerations

Calculating and displaying power information will always have some associated ripple that will depend on the integration period used in the MCU to determine average power and also the load. For example, at light loads the output frequency may be 10 Hz. With an integration period of two seconds, only about 20 pulses will be counted. The possibility of missing one pulse always exists as the AD7755 output frequency is running asynchronously to the MCU timer. This would result in a one-in-twenty or 5% error in the power measurement.

TRANSFER FUNCTION

Frequency Outputs F1 and F2

The AD7755 calculates the product of two voltage signals (on Channel 1 and Channel 2) and then low-pass filters this product to extract real power information. This real power information is then converted to a frequency. The frequency information is output on F1 and F2 in the form of active low pulses. The pulse rate at these outputs is relatively low, e.g., 0.34 Hz maximum for ac signals with $S_0 = S_1 = 0$ —see Table III. This means that the frequency at these outputs is generated from real power information accumulated over a relatively long period of time. The result is an output frequency that is proportional to the average real power. The averaging of the real power signal is implicit to the digital-to-frequency conversion. The output frequency or pulse rate is related to the input voltage signals by the following equation.

$$F_{req} = \frac{8.06 \times V_1 \times V_2 \times \text{Gain} \times F_{1-4}}{V_{REF}^2}$$

where:

- F_{req} = Output frequency on F1 and F2 (Hz)
- V_1 = Differential rms voltage signal on Channel 1 (volts)
- V_2 = Differential rms voltage signal on Channel 2 (volts)
- Gain = 1, 2, 8 or 16, depending on the PGA gain selection made using logic inputs G0 and G1
- V_{REF} = The reference voltage ($2.5 \text{ V} \pm 8\%$) (volts)
- F_{1-4} = One of four possible frequencies selected by using the logic inputs S0 and S1—see Table II.

Table II. F_{1-4} Frequency Selection

S1	S0	F_{1-4} (Hz)	XTAL/CLKIN*
0	0	1.7	$3.579 \text{ MHz}/2^{21}$
0	1	3.4	$3.579 \text{ MHz}/2^{20}$
1	0	6.8	$3.579 \text{ MHz}/2^{19}$
1	1	13.6	$3.579 \text{ MHz}/2^{18}$

NOTE

* F_{1-4} is a binary fraction of the master clock and therefore will vary if the specified CLKIN frequency is altered.

Example 1

Thus if full-scale differential dc voltages of +470 mV and -660 mV are applied to V1 and V2 respectively (470 mV is the maximum differential voltage that can be connected to Channel 1 and 660 mV is the maximum differential voltage that can be connected to Channel 2), the expected output frequency is calculated as follows:

- Gain = 1, $G_0 = G_1 = 0$
- $F_{1-4} = 1.7 \text{ Hz}$, $S_0 = S_1 = 0$
- V1 = +470 mV dc = 0.47 V (rms of dc = dc)
- V2 = -660 mV dc = 0.66 V (rms of dc = |dc|)
- $V_{REF} = 2.5 \text{ V}$ (nominal reference value).

NOTE: If the on-chip reference is used, actual output frequencies may vary from device to device due to reference tolerance of ±8%.

$$Freq = \frac{8.06 \times 0.47 \times 0.66 \times 1 \times 1.7}{2.5^2} = 0.68$$

Example 2

In this example, with ac voltages of ±470 mV peak applied to V1 and ±660 mV peak applied to V2, the expected output frequency is calculated as follows:

- Gain = 1, $G_0 = G_1 = 0$
- $F_{1-4} = 1.7 \text{ Hz}$, $S_0 = S_1 = 0$
- V1 = rms of 470 mV peak ac = $0.47/\sqrt{2}$ volts
- V2 = rms of 660 mV peak ac = $0.66/\sqrt{2}$ volts
- $V_{REF} = 2.5 \text{ V}$ (nominal reference value).

NOTE: If the on-chip reference is used, actual output frequencies may vary from device to device due to reference tolerance of ±8%.

$$Freq = \frac{8.06 \times 0.47 \times 0.66 \times 1 \times 1.7}{\sqrt{2} \times \sqrt{2} \times 2.5^2} = 0.34$$

As can be seen from these two example calculations, the maximum output frequency for ac inputs is always half of that for dc input signals. Table III shows a complete listing of all maximum output frequencies.

Table III. Maximum Output Frequency on F1 and F2

S1	S0	Max Frequency for DC Inputs (Hz)	Max Frequency for AC Inputs (Hz)
0	0	0.68	0.34
0	1	1.36	0.68
1	0	2.72	1.36
1	1	5.44	2.72

Frequency Output CF

The pulse output CF (Calibration Frequency) is intended for use during calibration. The output pulse rate on CF can be up to 2048 times the pulse rate on F1 and F2. The lower the F_{1-4} frequency selected, the higher the CF scaling (except for the high frequency mode SCF = 0, S1 = S0 = 1). Table IV shows how the two frequencies are related, depending on the states of

the logic inputs S0, S1 and SCF. Because of its relatively high pulse rate, the frequency at this logic output is proportional to the instantaneous real power. As is the case with F1 and F2, the frequency is derived from the output of the low-pass filter after multiplication. However, because the output frequency is high, this real power information is accumulated over a much shorter time. Hence less averaging is carried out in the digital-to-frequency conversion. With much less averaging of the real power signal, the CF output is much more responsive to power fluctuations—see Signal Processing Block in Figure 20.

Table IV. Maximum Output Frequency on CF

SCF	S1	S0	F_{1-4} (Hz)	CF Max for AC Signals (Hz)
1	0	0	1.7	$128 \times F_1$, $F_2 = 43.52$
0	0	0	1.7	$64 \times F_1$, $F_2 = 21.76$
1	0	1	3.4	$64 \times F_1$, $F_2 = 43.52$
0	0	1	3.4	$32 \times F_1$, $F_2 = 21.76$
1	1	0	6.8	$32 \times F_1$, $F_2 = 43.52$
0	1	0	6.8	$16 \times F_1$, $F_2 = 21.76$
1	1	1	13.6	$16 \times F_1$, $F_2 = 43.52$
0	1	1	13.6	$2048 \times F_1$, $F_2 = 5.57 \text{ kHz}$

SELECTING A FREQUENCY FOR AN ENERGY METER APPLICATION

As shown in Table II, the user can select one of four frequencies. This frequency selection determines the maximum frequency on F1 and F2. These outputs are intended to be used to drive the energy register (electromechanical or other). Since only four different output frequencies can be selected, the available frequency selection has been optimized for a meter constant of 100 imp/kWhr with a maximum current of between 10 A and 120 A. Table V shows the output frequency for several maximum currents (I_{MAX}) with a line voltage of 220 V. In all cases the meter constant is 100 imp/kWhr.

Table V. F1 and F2 Frequency at 100 imp/kWhr

I_{MAX}	F1 and F2 (Hz)
12.5 A	0.076
25 A	0.153
40 A	0.244
60 A	0.367
80 A	0.489
120 A	0.733

The F_{1-4} frequencies allow complete coverage of this range of output frequencies on F1 and F2. When designing an energy meter the nominal design voltage on Channel 2 (voltage) should be set to half-scale to allow for calibration of the meter constant. The current channel should also be no more than half-scale when the meter sees maximum load. This will allow over current signals and signals with high crest factors to be accommodated. Table VI shows the output frequency on F1 and F2 when both analog inputs are half-scale. The frequencies listed in Table VI align very well with those listed in Table V for maximum load.

AD7755

Table VI. F1 and F2 Frequency with Half-Scale AC Inputs

S1	S0	F ₁₋₄	Frequency on F1 and F2- CH1 and CH2 Half-Scale AC Inputs
0	0	1.7	0.085 Hz
0	1	3.4	0.17 Hz
1	0	6.8	0.34 Hz
1	1	13.6	0.68 Hz

When selecting a suitable F₁₋₄ frequency for a meter design, the frequency output at I_{MAX} (maximum load) with a meter constant of 100 imp/kWhr should be compared with Column 4 of Table VI. The frequency that is closest in Table VI will determine the best choice of frequency (F₁₋₄). For example, if a meter with a maximum current of 25 A is being designed, the output frequency on F1 and F2 with a meter constant of 100 imp/kWhr is 0.153 Hz at 25 A and 220 V (from Table V). Looking at Table VI, the closest frequency to 0.153 Hz in column four is 0.17 Hz. Therefore F₂ (3.4 Hz—see Table II) is selected for this design.

Frequency Outputs

Figure 1 shows a timing diagram for the various frequency outputs. The outputs F1 and F2 are the low frequency outputs that can be used to directly drive a stepper motor or electromechanical impulse counter. The F1 and F2 outputs provide two alternating low going pulses. The pulsewidth (t₁) is set at 275 ms and the time between the falling edges of F1 and F2 (t₃) is approximately half the period of F1 (t₂). If however the period of F1 and F2 falls below 550 ms (1.81 Hz) the pulsewidth of F1 and F2 is set to half of their period. The maximum output frequencies for F1 and F2 are shown in Table III.

The high frequency CF output is intended to be used for communications and calibration purposes. CF produces a 90 ms-wide active high pulse (t₄) at a frequency proportional to active power. The CF output frequencies are given in Table IV. As in the case of F1 and F2, if the period of CF (t₅) falls below 180 ms, the CF pulsewidth is set to half the period. For example, if the CF frequency is 20 Hz, the CF pulsewidth is 25 ms.

NOTE: When the high frequency mode is selected, (i.e., SCF = 0, S1 = S0 = 1) the CF pulsewidth is fixed at 18 μs. Therefore t₄ will always be 18 μs, regardless of output frequency on CF.

NO LOAD THRESHOLD

The AD7755 also includes a “no load threshold” and “start-up current” feature that will eliminate any creep effects in the meter. The AD7755 is designed to issue a minimum output frequency on all modes except when SCF = 0 and S1 = S0 = 1. The no-load detection threshold is disabled on this output mode to accommodate specialized application of the AD7755. Any load generating a frequency lower than this minimum frequency will not cause a pulse to be issued on F1, F2 or CF. The minimum output frequency is given as 0.0014% of the full-scale output frequency for each of the F₁₋₄ frequency selections—see Table II. For example, an energy meter with a meter constant of 100 imp/kWhr on F1, F2 using F₂ (3.4 Hz), the maximum output frequency at F1 or F2 would be 0.0014% of 3.4 Hz or 4.76 × 10⁻⁵ Hz. This would be 3.05 × 10⁻³ Hz at CF (64 × F1 Hz). In this example the no-load threshold would be equivalent to 1.7 W of load of a start-up current of 8 mA at 220 V. Comparing this value to the IEC1036 specification which states that the meter must start up with a load equal to or less than 0.4% I_b. For a 5A (I_b) meter 0.4% of I_b is equivalent to 20 mA.

OUTLINE DIMENSIONS

Dimensions shown in inches and (mm).

24-Lead Plastic DIP (N-24)

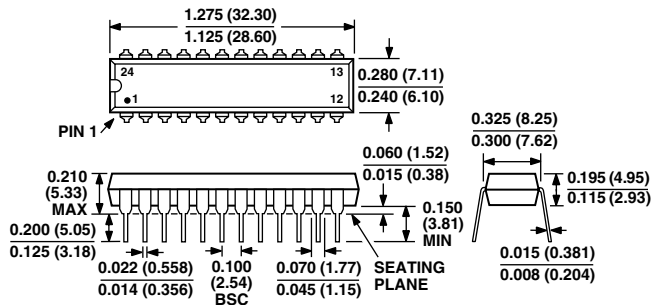

24-Lead Shrink Small Outline Package (RS-24)

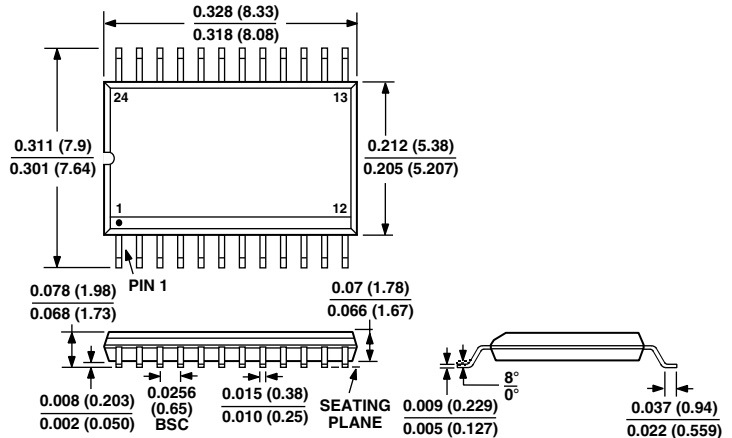

C01022a-0-8/00 (rev. B)

PRINTED IN U.S.A.