

ISL29015

Integrated Digital Ambient Light Sensor and Proximity Sensor

FN6522
Rev 0.00
October 31, 2008

The ISL29015 is an integrated ambient and infrared light to digital converter with a built-in IR LED driver and I²C/SMBus interface. This device provides not only ambient light sensing to allow robust backlight/display brightness control but also infrared sensing to allow proximity estimation.

For ambient light sensing, an internal 16-bit ADC has been designed based on the charge-balancing A/D conversion technique. The ADC conversion time is nominally 100ms and is user adjustable from 25µs to 100ms depends on oscillator frequency and ADC resolution. This ADC is capable of rejecting 50Hz and 60Hz flicker noise caused by artificial light sources. The lux-range-select feature allows users to program the lux range for optimized counts/lux.

For proximity sensing, the ADC is used to digitize the output signal from the photodiode array when the internal IR LED driver is turned on and off for the programmed time periods under user-selected modulation frequency to drive the external IR LED. As this proximity sensor employs a noise cancellation scheme to highly reject unwanted IR noise, the digital output of proximity sensing decreases with distance. The driver output current is user selectable up to 100mA to drive different types of IR emitters LEDs.

Six different modes of operation can be selected via the I²C interface: Programmable ALS once with auto power-down, programmable IR sensing once, programmable proximity sensing once, programmable continuous ALS sensing, programmable continuous IR sensing and programmable continuous proximity sensing. The programmable one-time operation modes greatly reduce power because an immediate automatic shutdown reduces overall supply current less than 1µA.

Designed to operate on supplies from 2.25V to 3.3V, the ISL29015 is specified for operation over the -40°C to +85°C ambient temperature range. It is packaged in a clear, Pb-free 6 Ld ODFN package.

Pinout

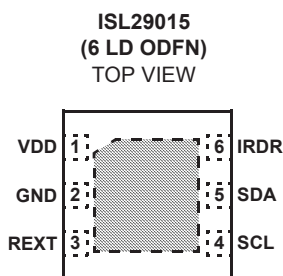

*EXPOSED PAD CAN BE CONNECTED TO GND OR ELECTRICALLY ISOLATED

Features

Proximity Sensing

- Ambient IR Cancellation During Proximity Sensing
 - Works Under Direct Sunlight
- IR LED Driver with Programmable Source Current
 - Adjustable Current Drive from 100mA to 12.5mA
- Programmable LED current Modulation Frequency
- Variable Conversion Resolution up to 16-bits

Ambient Light Sensing

- Simple Output Code Directly Proportional to lux
- Adjustable Sensitivity up to 65 Counts per lux
- Selectable Range (via I²C)
 - Range 1 = 0.015 lux to 1,000 lux
 - Range 2 = 0.06 lux to 4,000 lux
 - Range 3 = 0.24 lux to 16,000 lux
 - Range 4 = 0.96 lux to 64,000 lux
- Integrated 50/60Hz Noise Rejection
- Works Under Various Light Sources, Including Sunlight

Ideal Spectral Response for Light and Proximity Sensor

- Light Sensor Close to Human Eye Response
 - Excellent Light Sensor IR and UV Rejection
- Proximity sensor range from 850nm to 950nm
 - Can use either 850nm or 950nm LED solution

Ultra Low Power

- 90µA Max Operating Current
 - 1.0µA Max Shutdown Current
- Software Shutdown and Automatic Shutdown

Easy to Use

- I²C (SMBus Compatible) Output
- No Complex Algorithms Needed
- Temperature Compensated
- Small Form Factor
 - 2.0x2.1x0.7mm 6 Ld ODFN Package

Additional Features

- I²C and SMBus Compatible
- 1.7V to 3.63V Supply for I²C Interface
- 2.25V to 3.3V Supply
- Pb-Free (RoHS compliant)

Applications

- Display and Keypad Dimming Adjustment and Proximity Sensing for:
 - Mobile Devices: Smart Phone, PDA, GPS
 - Computing Devices: Notebook PC, Webpad
 - Consumer Devices: LCD-TV, Digital Picture Frame, Digital Camera
- Industrial and Medical Light and Proximity Sensing

Ordering Information

PART NUMBER (Note)	TEMP. RANGE (°C)	PACKAGE (Pb-Free)	PKG. DWG. #
ISL29015IROZ-T7*	-40 to +85	6 Ld ODFN	L6.2x2.1
ISL29015IROZ-EVALZ	Evaluation Board		

*Please refer to TB347 for details on reel specifications.

NOTE: These Intersil Pb-free plastic packaged products employ special Pb-free material sets; molding compounds/die attach materials and NiPdAu plate - e4 termination finish, which is RoHS compliant and compatible with both SnPb and Pb-free soldering operations. Intersil Pb-free products are MSL classified at Pb-free peak reflow temperatures that meet or exceed the Pb-free requirements of IPC/JEDEC J STD-020.

Pin Descriptions

PIN NUMBER	PIN NAME	DESCRIPTION
1	VDD	Positive supply: 2.25V to 3.3V.
2	GND	Ground pin.
3	REXT	External resistor pin setting the internal reference current and the conversion time. 499kΩ with 1% tolerance resistor is recommended.
4	SCL	I ² C serial clock line
5	SDA	I ² C serial data line
6	IRDR	IR LED driver pin connecting to the anode of the external IR LED. The source current of the IR LED driver can be programmed through I ² C.
		Exposed pad connected to ground or electrically isolated.

Block Diagram

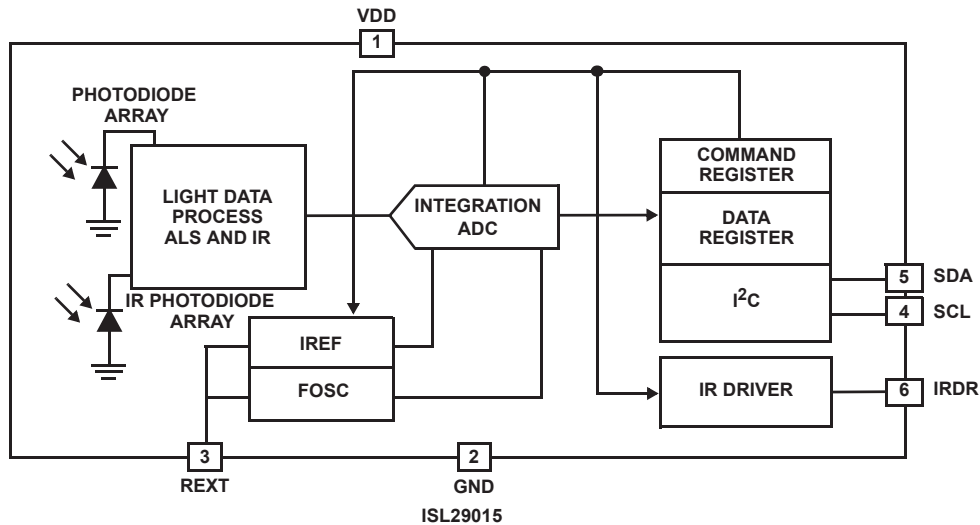

Absolute Maximum Ratings ($T_A = +25^\circ\text{C}$)

V_{DD} Supply Voltage between V_{DD} and GND	3.6V
I ² C Bus (SCL, SDA) Pin Voltage	-0.2V to 4V
I ² C Bus (SCL, SDA) Pin Current	<10mA
IRDR Pin Voltage	-0.2V to $V_{DD} + 0.5V$
R _{EXT} Pin Voltage	-0.2V to $V_{DD} + 0.5V$
ESD Rating	
Human Body Model	2kV

Thermal Information

Thermal Resistance (Typical, Note 1)	θ_{JA} ($^\circ\text{C}/\text{W}$)
6 Ld ODFN	88
Maximum Die Temperature	+90 $^\circ\text{C}$
Storage Temperature	-40 $^\circ\text{C}$ to +100 $^\circ\text{C}$
Operating Temperature	-40 $^\circ\text{C}$ to +85 $^\circ\text{C}$
Pb-Free Reflow Profile	see link below
	http://www.intersil.com/pbfree/Pb-FreeReflow.asp

CAUTION: Do not operate at or near the maximum ratings listed for extended periods of time. Exposure to such conditions may adversely impact product reliability and result in failures not covered by warranty.

NOTE:

- θ_{JA} is measured in free air with the component mounted on a high effective thermal conductivity test board with "direct attach" features. See Tech Brief TB379.

IMPORTANT NOTE: All parameters having Min/Max specifications are guaranteed. Typical values are for information purposes only. Unless otherwise noted, all tests are at the specified temperature and are pulsed tests, therefore: $T_J = T_C = T_A$

Electrical Specifications $V_{DD} = 3V$, $T_A = +25^\circ\text{C}$, $R_{EXT} = 499k\Omega$ 1% tolerance, 16-bit ADC operation, unless otherwise specified.

PARAMETER	DESCRIPTION	CONDITION	MIN	TYP	MAX	UNIT
V_{DD}	Power Supply Range		2.25		3.3	V
I_{DD}	Supply Current when Powered Down	Software disabled or auto power-down		0.1	1	μA
I_{DD1}	Supply Current of Ambient Light and IR Sensing			70	90	μA
V_{I^2C}	Supply Voltage Range for I ² C Interface		1.7		3.63	V
f_{OSC}	Internal Oscillator Frequency		650	725	800	kHz
t_{int}	ADC Integration/Conversion Time	16-bit ADC data		90		ms
F_{I^2C}	I ² C Clock Rate Range			1 to 400		kHz
DATA_0	Count Output When Dark	E = 0 lux		1	5	Counts
DATA_FS	Full Scale ADC Code				65535	Counts
$\frac{\Delta\text{DATA}}{\text{DATA}}$	Count Output Variation Over Three Light Sources: Fluorescent, Incandescent and Sunlight	Ambient light sensing		± 10		%
DATA_1	Light Count Output With LSB of 0.015 lux/count	E = 300 lux, Fluorescent light (Note 2), Ambient light sensing, Range 1 (1k lux)	15000	20000	25000	Counts
DATA_2	Light Count Output With LSB of 0.06 lux/count	E = 300 lux, Fluorescent light (Note 2), Ambient light sensing, Range 2 (4k lux)		5000		Counts
DATA_3	Light Count Output With LSB of 0.024 lux/count	E = 300 lux, Fluorescent light (Note 2), Ambient light sensing, Range 3 (16k lux)		1250		Counts
DATA_4	Light Count Output With LSB of 0.96 lux/count	E = 300 lux, Fluorescent light (Note 2), Ambient light sensing, Range 4 (64k lux)		312		Counts
DATA_IR1	Infrared Count Output	E = 210 lux, Sunlight (Note 3), IR sensing, Range 1	15000	20000	25000	Counts
DATA_IR2	Infrared Count Output	E = 210 lux, Sunlight (Note 3), IR sensing, Range 2		5000		Counts
DATA_IR3	Infrared Count Output	E = 210 lux, Sunlight (Note 3), IR sensing, Range 3		1250		Counts
DATA_IR4	Infrared Count Output	E = 210 lux, Sunlight (Note 3), IR sensing, Range 4		312		Counts
V_{REF}	Voltage of R _{EXT} Pin			0.52		V
V_{IL}	SCL and SDA Input Low Voltage				0.6	V
V_{IH}	SCL and SDA Input High Voltage		1.5			V

Electrical Specifications $V_{DD} = 3V$, $T_A = +25^{\circ}C$, $R_{EXT} = 499k\Omega$ 1% tolerance, 16-bit ADC operation, unless otherwise specified. **(Continued)**

PARAMETER	DESCRIPTION	CONDITION	MIN	TYP	MAX	UNIT	
I_{SDA}	SDA Current Sinking Capability		4	5		mA	
I_{IRDR1}	IRDR Source Current	$IS<1:0> = 0$ (Note 4)		100		mA	
I_{IRDR2}	IRDR Source Current	$IS<1:0> = 1$ (Note 4)	1.5V at IRDR pin	44	50	56	mA
I_{IRDR3}	IRDR Source Current	$IS<1:0> = 2$ (Note 4)			25		mA
I_{IRDR4}	IRDR Source Current	$IS<1:0> = 3$ (Note 4)			12.5		mA
V_{IRLED}	Voltage Head Room of IRDR Pin				$V_{DD} - 0.6$		V
t_r	Rise Time for IRDR Source Current	$R_{LOAD} = 15\Omega$ at IRDR pin, 20% to 80%		35		ns	
t_f	Fall Time for IRDR Source Current	$R_{LOAD} = 15\Omega$ at IRDR pin, 80% to 20%		10		ns	
f_{IRLED1}	IR LED Modulation Frequency	$Freq<1:0> = 0$ (Note 4)		DC		kHz	
f_{IRLED2}	IR LED Modulation Frequency	$Freq<1:0> = 3$ (Note 4)		360		kHz	
I_{DD} (IRLED1)	Supply Current of Proximity Sensing	$IS<1:0> = 0$, $Freq<1:0> = 0$ (Note 4)		101		mA	
I_{DD} (IRLED2)	Supply Current of Proximity Sensing	$IS<1:0> = 0$, $Freq<1:0> = 3$ (Note 4)		51		mA	
Duty Cycle	Duty Cycle of IR LED Modulation			50		%	
PROX-IR PROX	Differential ADC Output of IR and Proximity Sensing With Object Far Away to Provide No Reflection	IR and proximity sensing with Range 2; 1.5V @ IRDR pin, $IS<1:0> = 0$, $Freq<1:0> = 0$; E = 210 lux, Sunlight.		2.0		%	

NOTES:

- 550nm green LED is used in production test. The 550nm LED irradiance is calibrated to produce the same DATA count against an illuminance level of 300 lux fluorescent light.
- 850nm infrared LED is used in production test. The 850nm LED irradiance is calibrated to produce the same DATA_IR count against an illuminance level of 210 lux sunlight at sea level.
- See "Register Set" on page 6.

Principles of Operation

Photodiodes and ADC

The ISL29015 contains two photodiode arrays which convert light into current. The spectral response for ambient light sensing and IR sensing is shown in Figure 6 in the performance curves section. After light is converted to current during the light signal process, the current output is converted to digital by a built-in 16-bit Analog-to-Digital Converter (ADC). An I²C command reads the ambient light or IR intensity in counts.

The converter is a charge-balancing integrating type 16-bit ADC. The chosen method for conversion is best for converting small current signals in the presence of an AC periodic noise. A 100ms integration time, for instance, highly rejects 50Hz and 60Hz power line noise simultaneously.

The built-in ADC offers user flexibility in integration time or conversion time. There are two timing modes: Internal Timing Mode and External Timing Mode. In Internal Timing Mode, integration time is determined by an internal oscillator (f_{OSC}), and the n-bit ($n = 4, 8, 12, 16$) counter inside the ADC. In External Timing Mode, integration time is determined by the time between two consecutive I²C External Timing Mode commands. See "Integration and Conversion Time" on page 7. A good balancing act of integration time and resolution depending on the application is required for optimal results.

The ADC has I²C programmable range select to dynamically accommodate various lighting conditions. For very dim conditions, the ADC can be configured at its lowest range (Range 1) in the ambient light sensing. For very bright conditions, the ADC can be configured at its highest range (Range 4) in the proximity sensing.

Low-Power Operation

The ISL29015 initial operation is at the power-down mode after a supply voltage is provided. The data registers contain the default value of 0. When the ISL29015 receives an I²C command to do a one-time measurement from an I²C master, it will start ADC conversion with light or proximity sensing. It will go to the power-down mode automatically after one conversion is finished and keep the conversion data available for the master to fetch anytime afterwards. The ISL29015 will continuously do ADC conversion with light or proximity sensing if it receives an I²C command of continuous measurement. It will continuously update the data registers with the latest conversion data. It will go to the power-down mode after it receives the I²C command of power-down.

Ambient Light, IR and Proximity Sensing

There are six operational modes in ISL29015: Programmable ALS once with auto power-down, programmable IR sensing once with auto power-down, programmable proximity sensing once with auto power-down; programmable continuous ALS sensing, programmable continuous IR sensing and programmable continuous proximity sensing. These six modes can be

programmed in series to fulfill the application needs. The detailed program configuration is listed in "Register Set" on page 6.

When the part is programmed for ambient light sensing, the ambient light with wavelength within the "Ambient Light Sensing" spectral response curve in Figure 6 is converted into current. With ADC, the current is converted to an unsigned n-bit (up to 16 bits) digital output.

When the part is programmed for infrared (IR) sensing, the IR light with wavelength within the "IR or Proximity Sensing" spectral response curve on Figure 6 is converted into current. With ADC, the current is converted to an unsigned n-bit (up to 16 bits) digital output.

When the part is programmed for proximity sensing, the external IR LED is turned on by the built-in IR LED driver through the IRDR pin. The amplitude of the IR LED current and the IR LED modulation frequency can be programmed through Command Register II. When the IR from the LED reaches an object and gets reflected back, the reflected IR light with wavelength within the "IR or Proximity Sensing" spectral response curve in Figure 6 is converted into current. With ADC, the current is converted to an unsigned n-bit (up to 16 bits) digital output. The output reading is inversely proportional to the square of the distance between the sensor and the object. When there is significant background IR noise like direct sunlight, both IR and proximity sensing can be implemented for background noise cancellation. The differential output reading from the ADC decreases with distance.

I²C Interface

There are four 8-bit registers available inside the ISL29015. The two command registers define the operation of the device. The command registers do not change until the registers are overwritten. The two 8-bit data Read Only registers are for the ADC output. The data registers contain the ADC's latest digital output, or the number of clock cycles in the previous integration period.

The ISL29015's I²C interface slave address is internally hardwired as 1000100. When 1000100x with x as R or \bar{W} is sent after the Start condition, this device compares the first seven bits of this byte to its address and matches.

Figure 1 shows a sample one-byte read. Figure 2 shows a sample one-byte write. The I²C bus master always drives the SCL (clock) line, while either the master or the slave can drive the SDA (data) line. Figure 2 shows a sample write. Every I²C transaction begins with the master asserting a start condition (SDA falling while SCL remains high). The following byte is driven by the master, and includes the slave address and read/write bit. The receiving device is responsible for pulling SDA low during the acknowledgement period. Every I²C transaction ends with the master asserting a stop condition (SDA rising while SCL remains high).

For more information about the I²C standard, please consult the Philips™ I²C specification documents.

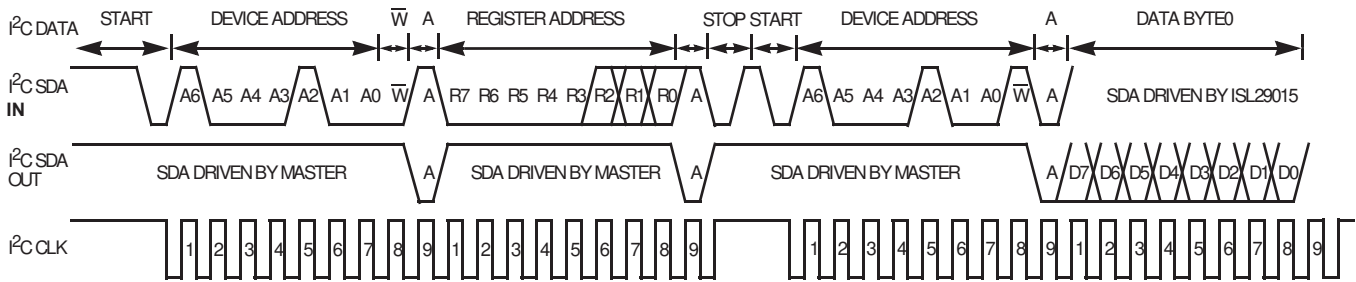

FIGURE 1. I²C READ TIMING DIAGRAM SAMPLE

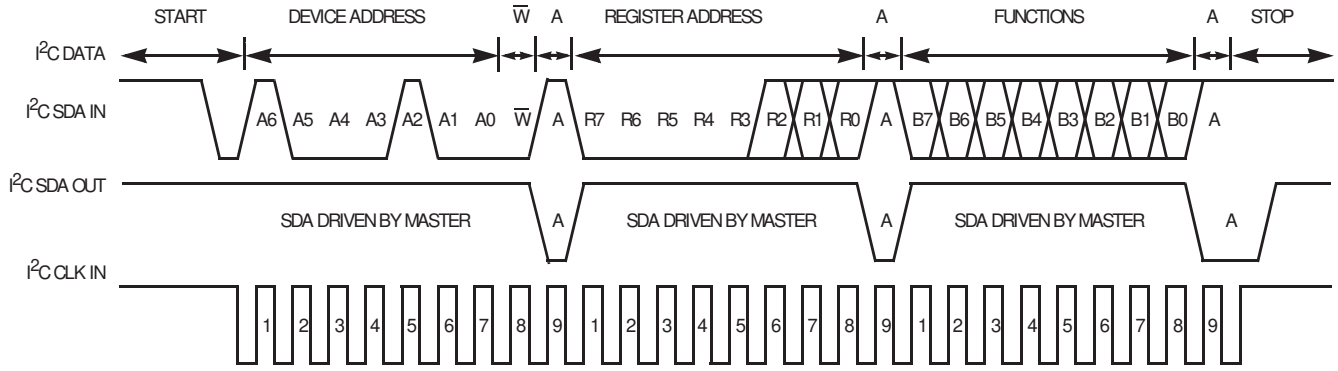

FIGURE 2. I²C WRITE TIMING DIAGRAM SAMPLE

Register Set

There are four registers that are available in the ISL29015. Table 1 summarizes their functions.

TABLE 1. REGISTER SET

ADDR	REG NAME	BIT								DEFAULT
		7	6	5	4	3	2	1	0	
00h	COMMANDI	OP2	OP1	OP0	0	0	0	0	0	00h
01h	COMMANDII	IS1	IS0	FREQ1	FREQ0	RES1	RES0	RANGE1	RANGE0	00h
02h	DATA _{LSB}	D7	D6	D5	D4	D3	D2	D1	D0	00h
03h	DATA _{MSB}	D15	D14	D13	D12	D11	D10	D9	D8	00h

Command Register I 00(hex)

The first command register has the following functions:

1. Operation Mode: Bits 7, 6, and 5. These three bits determines the operation mode of the device.

TABLE 2. OPERATION MODE

BITS 7 TO 5	OPERATION
000	Power-down the device
001	ALS once
010	IR once
011	Proximity once
100	Reserved
101	ALS continuous
110	IR continuous
111	Proximity continuous

2. Bit 4 to 0 has been reserved to 0.

Command Register II 01(hex)

The second command register has the following functions:

1. Amplitude of IR driver current: Bits 7 and 6. This device provides current source to drive an external IR LED. The drive capability can be programmed through Bits 7 and 6.

For example, the device sources 100mA out of the IRDR pin if Bits 7 and 6 are 0 during proximity sensing.

TABLE 3. CURRENT SOURCE CAPABILITY AT IRDR PIN

BITS 7: 6	IRDR PIN SOURCE CURRENT
00	100mA IR LED driver
01	50mA IR LED driver
10	25mA IR LED driver
11	12.5mA IR LED driver

2. Modulation Frequency: Bits 5 and 4. These two bits set the IR LED driver’s modulation frequency.

TABLE 4. MODULATION FREQUENCY

BITS 5:4	MODULATION FREQUENCY (kHz)
00	DC
01	N/A
10	N/A
11	360

3. Resolution: Bits 3 and 2. Bits 3 and 2 determine the ADC’s resolution and the number of clock cycles per conversion in Internal Timing Mode. Changing the number of clock cycles does more than just change the resolution of the device. It also changes the integration time, which is the period the

device's analog-to-digital (A/D) converter samples the photodiode current signal for a measurement.

TABLE 5. RESOLUTION/WIDTH

BITS 3:2	NUMBER OF CLOCK CYCLES	n-BIT ADC
00	$2^{16} = 65,536$	16
01	$2^{12} = 4,096$	12
10	$2^8 = 256$	8
11	$2^4 = 16$	4

4. Range: Bits 1 and 0. The Full Scale Range (FSR) can be adjusted via I²C using Bits 1 and 0. Table 6 lists the possible values of FSR for the 499k Ω R_{EXT} resistor.

TABLE 6. RANGE/FSR LUX

BITS 1:0	k	RANGE(k)	FSR (LUX) @ ALS SENSING	FSR @ IR SENSING
00	1	Range1	1,000	Refer to page 3
01	2	Range2	4,000	Refer to page 3
10	3	Range3	16,000	Refer to page 3
11	4	Range4	64,000	Refer to page 3

Data Registers (02 hex and 03 hex)

The device has two 8-bit read-only registers to hold the data from LSB to MSB for ADC. The most significant bit (MSB) is accessed at 03 hex, and the least significant bit (LSB) is accessed at 02 hex. For 16-bit resolution, the data is from D0 to D15; for 12-bit resolution, the data is from D0 to D11; for 8-bit resolution, the data is from D0 to D7. The registers are refreshed after every conversion cycle.

TABLE 7. DATA REGISTERS

ADDRESS (hex)	CONTENTS
02	D0 is LSB for 4, 8, 12 or 16-bit resolution, D3 is MSB for 4-bit resolution, D7 is MSB for 8-bit resolution
03	D15 is MSB for 16-bit resolution, D11 is MSB for 12-bit resolution

Calculating Lux

The ISL29015's ADC output codes, DATA, are directly proportional to lux in the ambient light sensing.

$$E_{\text{cal}} = \alpha \times \text{DATA} \quad (\text{EQ. 1})$$

Here, E_{cal} is the calculated lux reading. The constant α is determined by the Full Scale Range and the ADC's maximum output counts. The constant is independent on the light sources (fluorescent, incandescent and sunlight) because of the light sources' IR component is removed during the light signal process. The constant can also be viewed as the sensitivity: the smallest lux measurement the device can measure is shown in Equation 2.

$$\alpha = \frac{\text{Range}(k)}{\text{Count}_{\text{max}}} \quad (\text{EQ. 2})$$

Here, Range(k) is defined in Table 6. Count_{max} is the maximum output counts from the ADC.

The transfer function used for n-bit ADC becomes:

$$E_{\text{cal}} = \frac{\text{Range}(k)}{2^n} \times \text{DATA} \quad (\text{EQ. 3})$$

Here, n = 4, 8, 12 or 16. This is the number of ADC bits programmed in the command register. 2^n represents the maximum number of counts possible from the ADC output. Data is the ADC output stored in the data registers (02 hex and 03 hex).

Integration and Conversion Time

The ADC resolution and f_{OSC} determines the integration time, t_{int}.

$$t_{\text{int}} = 2^n \times \frac{1}{f_{\text{OSC}}} = 2^n \times \frac{R_{\text{EXT}}}{725\text{kHz} \times 499\text{k}\Omega} \quad (\text{EQ. 4})$$

where n is the number of bits of resolution and n = 4, 8, 12 or 16. 2^n , therefore, is the number of clock cycles. n can be programmed at the command register 01(hex) bits 3 and 2.

TABLE 8. INTEGRATION TIME OF n-BIT ADC

R _{EXT} (k Ω)	n = 16-BIT	n = 12-BIT	n = 8-BIT	n = 4-BIT
250	45ms	2.812ms	175.5 μ s	10.8 μ s
499**	90ms	5.63ms	351 μ s	21.6 μ s

**Recommended R_{EXT} resistor value

External Scaling Resistor R_{EXT} for f_{OSC} and Range

The ISL29015 uses an external resistor R_{EXT} to fix its internal oscillator frequency, f_{OSC} and the light sensing range. f_{OSC} and Range are inversely proportional to R_{EXT}. For user simplicity, the proportionality constant is referenced to 499k Ω :

$$\text{Range} = \frac{499\text{k}\Omega}{R_{\text{EXT}}} \times \text{Range}(k) \quad (\text{EQ. 5})$$

$$f_{\text{OSC}} = \frac{499\text{k}\Omega}{R_{\text{EXT}}} \times 725\text{kHz} \quad (\text{EQ. 6})$$

Noise Rejection

In general, integrating type ADC's have excellent noise-rejection characteristics for periodic noise sources whose frequency is an integer multiple of the conversion rate. For instance, a 60Hz AC unwanted signal's sum from 0ms to k*16.66ms (k = 1,2...k) is zero. Similarly, setting the device's integration time to be an integer multiple of the periodic noise signal, greatly improves the light sensor output signal in the presence of noise.

ADC Output in IR Sensing

The ISL29015's ADC output codes, DATA, are directly proportional to the IR intensity received in the IR sensing phase.

$$\text{DATA}_{\text{IR}} = \beta \times E_{\text{IR}} \quad (\text{EQ. 7})$$

Here, E_{IR} is the received IR intensity. The constant β changes with the spectrum of background IR noise like sunlight and incandescent light. The β also changes with the ADC's range and resolution selections.

ADC Output in Proximity Sensing

In the proximity sensing, the ADC output codes, DATA, are directly proportional to the total IR intensity from the background IR noise and from the IR LED driven by the ISL29015.

$$DATA_{PROX} = \beta \times E_{IR} + \gamma \times E_{LED} \quad (\text{EQ. 8})$$

β and E_{IR} in Equation 8 have the same meanings as in Equation 7. The constant γ depends on the spectrum of the used IR LED and the ADC's range and resolution selections. E_{LED} is the IR intensity which is emitted from the IR LED and reflected by a specific object to the ISL29015. E_{LED} depends on the current to the IR LED and the surface of the object. E_{LED} decreases with the square of the distance between the object and the sensor.

If background IR noise is small, i.e., E_{IR} can be neglected, the ADC output directly decreases with the distance. If there is significant background IR noise, the sequence of the proximity sensing followed by the IR sensing can be implemented. The differential reading of ADC outputs from the proximity and IR sensing has no effect of background IR noise and directly decreases with the distance between the object and the sensor. Please refer to "Typical Performance Curves" on page 10 for ADC output vs distance. Figure 9 shows ISL29015 configured at 12-bit ADC resolution, 12.5mA external LED current at 327.7KHz modulation frequency, detects three different sensing objects: 92% brightness paper, 18% gray card and ESD black foam. Figure 10 shows ISL29015 configured at 12-bit ADC resolution, programmed external LED at 327.7KHz modulation frequency, detects the same sensing object: 18% gray card under four different external LED current: 12.5mA, 25mA, 50mA and 100mA to compare the proximity readout versus distance.

Current Consumption Estimation

The low power operation is achieved through sequential readout in the serial fashion, as shown in Figure 3, the device requires three different phases in serial during the entire detection cycle to do ambient light sensing, infrared sensing and proximity sensing. The external IR LED will only be turned on during the proximity sensing phase under user program controlled current at modulated frequency depends on user selections. Figure 3 also shows the current consumption during each ALS, IR sensing and Proximity sensing phase. For example, at 8-bit ADC resolution the integration time is 0.4ms. If user programmed 50mA current to supply external IR LED at 327.7kHz modulated frequency, during the entire operation cycle that includes ALS, IR sensing and Proximity sensing three different serial phases, the detection occurs once every

30ms, the average current consumption including external IR LED drive current can be calculated from Equation 9:

$$[(0.05\text{mA} + 0.05\text{mA} + 1\text{mA} + (50\text{mA} \times 50\%)) \times 0.4\text{ms}] / 30\text{ms} = 0.35\text{mA} \quad (\text{EQ. 9})$$

If at a 12-bit ADC resolution where the integration time for each serial phase becomes 7ms and the total detection time becomes 100ms, the average current can be calculated from Equation 10:

$$[(0.05\text{mA} + 0.05\text{mA} + 1\text{mA} + (50\text{mA} \times 50\%)) \times 7\text{ms}] / 100\text{ms} = 1.83\text{mA} \quad (\text{EQ. 10})$$

Suggested PCB Footprint

It is important that the users check the "Surface Mount Assembly Guidelines for Optical Dual FlatPack No Lead (ODFN) Package" before starting ODFN product board mounting.

<http://www.intersil.com/data/tb/tb477.pdf>

Layout Considerations

The ISL29015 is relatively insensitive to layout. Like other I²C devices, it is intended to provide excellent performance even in significantly noisy environments. There are only a few considerations that will ensure best performance.

Route the supply and I²C traces as far as possible from all sources of noise. Use two power-supply decoupling capacitors, 1 μ F and 0.1 μ F, placed close to the device.

Typical Circuit

A typical application for the ISL29015 is shown in Figure 4. The ISL29015's I²C address is internally hardwired as 1000100. The device can be tied onto a system's I²C bus together with other I²C compliant devices.

Soldering Considerations

Convection heating is recommended for reflow soldering; direct-infrared heating is not recommended. The plastic ODFN package does not require a custom reflow soldering profile, and is qualified to +260°C. A standard reflow soldering profile with a +260°C maximum is recommended.

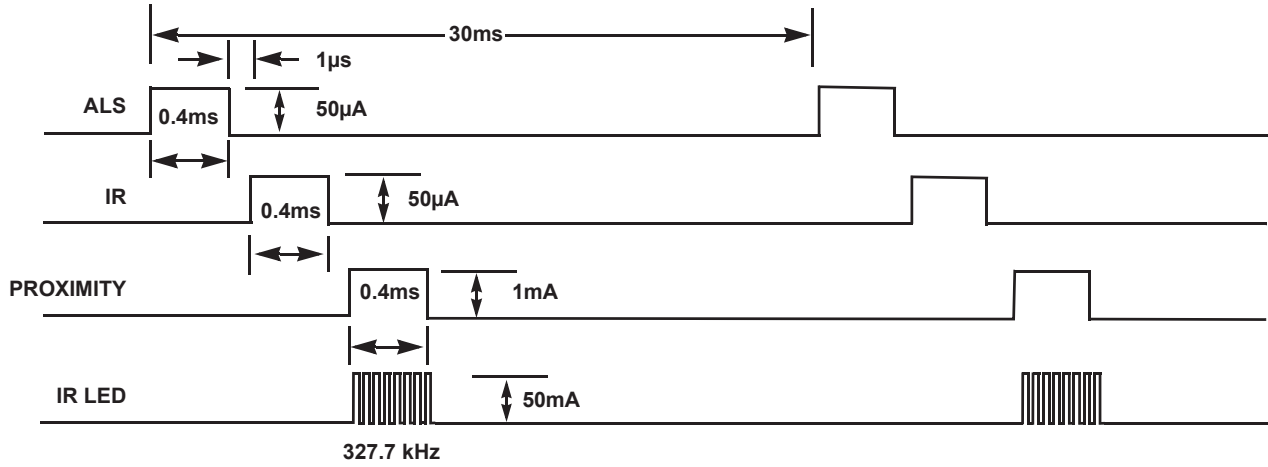

FIGURE 3. CURRENT CONSUMPTION FOR EACH INTEGRATION PHASE AND DETECTION CYCLE

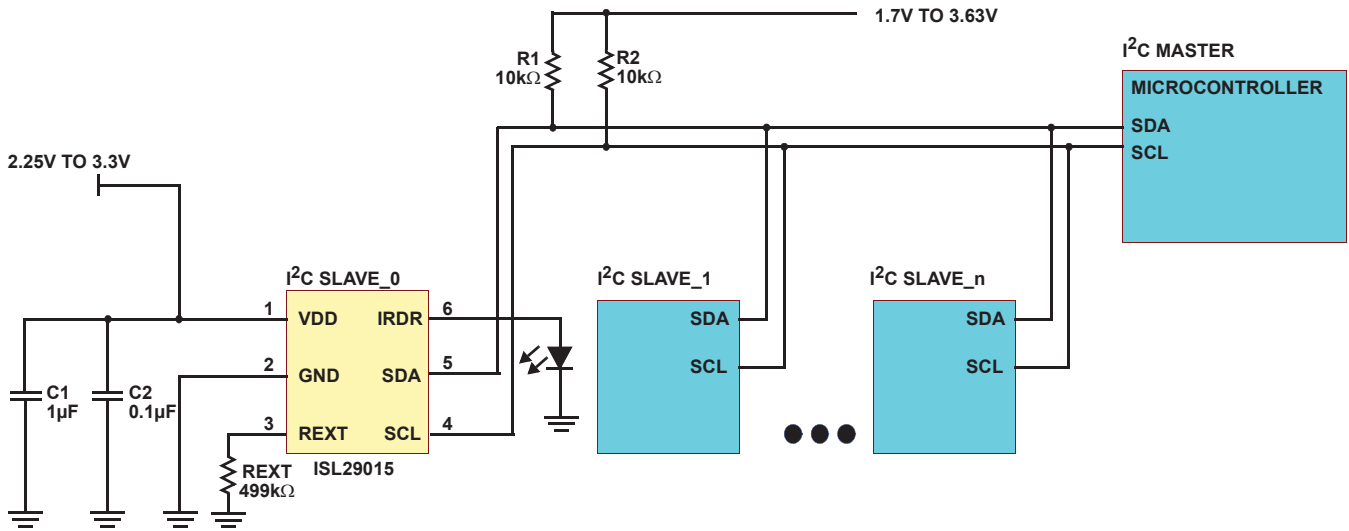

FIGURE 4. ISL29015 TYPICAL CIRCUIT

Typical Performance Curves $V_{DD} = 3V$, $R_{ext} = 499k\Omega$

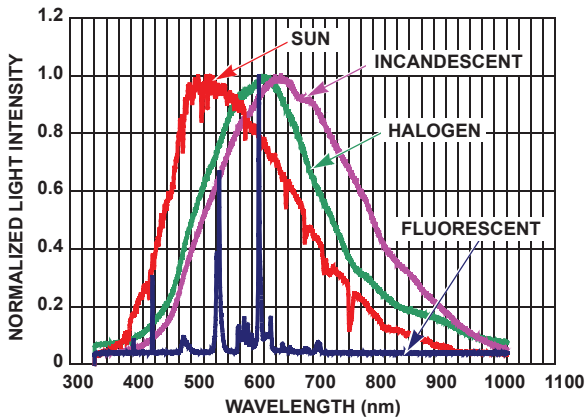

FIGURE 5. SPECTRUM OF FOUR LIGHT SOURCES

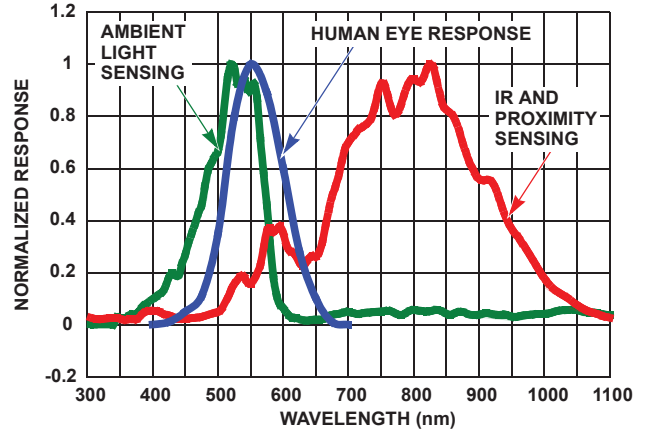

FIGURE 6. SPECTRAL RESPONSE FOR AMBIENT LIGHT SENSING AND PROXIMITY SENSING

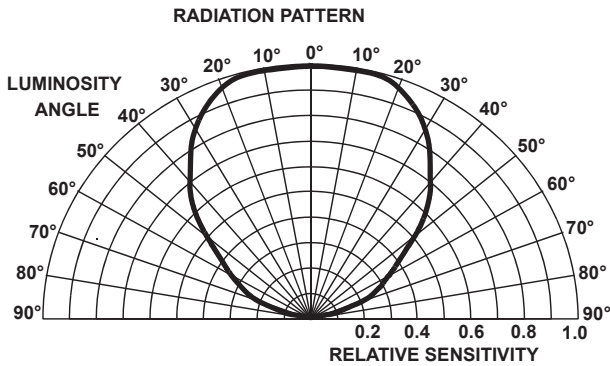

FIGURE 7. RADIATION PATTERN

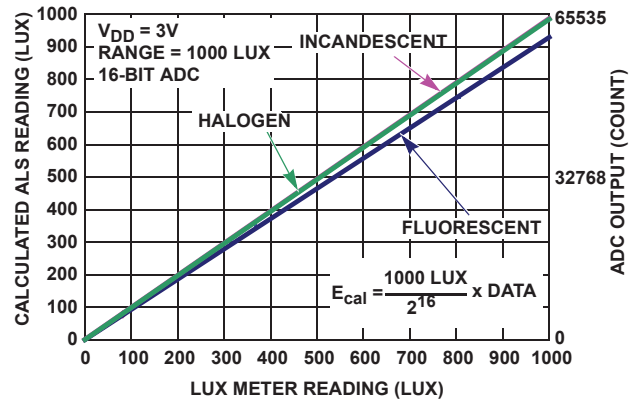

FIGURE 8. SENSITIVITY TO FOUR LIGHT SOURCES

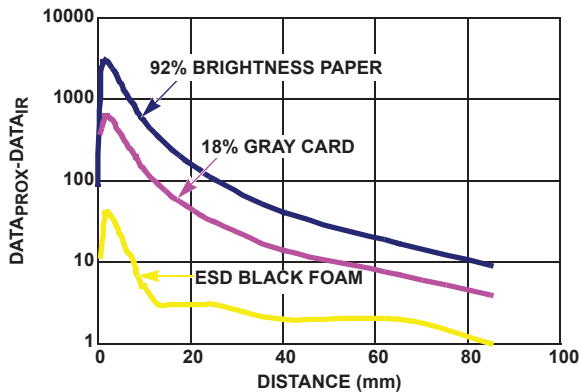

FIGURE 9. ADC OUTPUT vs DISTANCE WITH DIFFERENT OBJECTS IN PROXIMITY SENSING

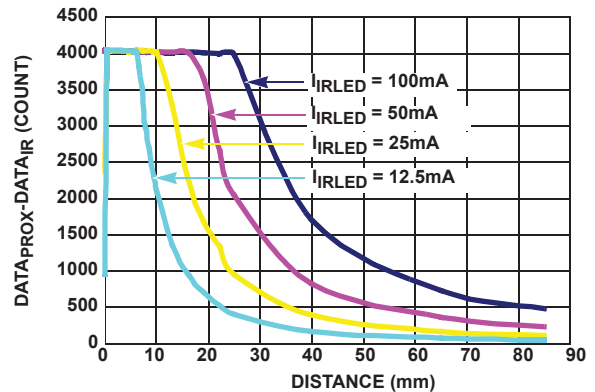

FIGURE 10. ADC OUTPUT vs DISTANCE WITH DIFFERENT LED CURRENT AMPLITUDES IN PROXIMITY SENSING

Typical Performance Curves $V_{DD} = 3V$, $R_{ext} = 499k\Omega$ (Continued)

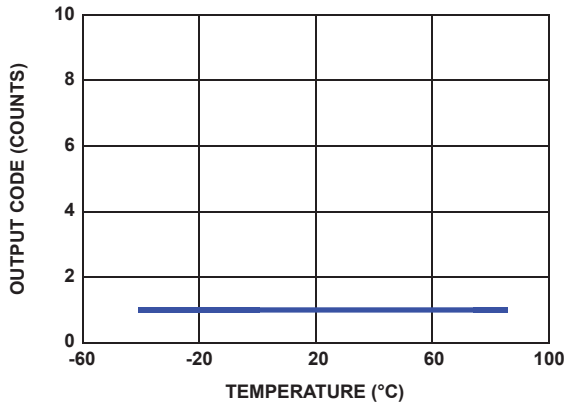

FIGURE 11. OUTPUT CODE FOR 0 LUX vs TEMPERATURE

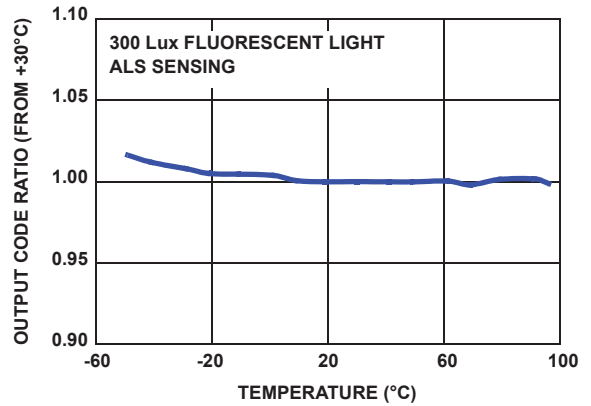

FIGURE 12. OUTPUT CODE vs TEMPERATURE

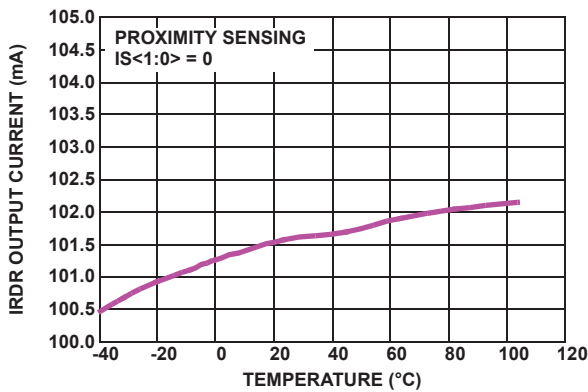

FIGURE 13. OUTPUT CURRENT vs TEMPERATURE IN PROXIMITY SENSING

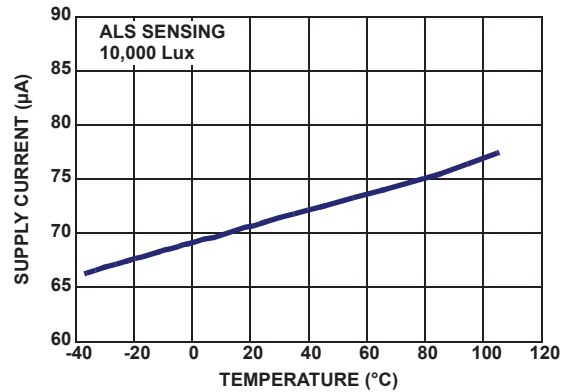

FIGURE 14. SUPPLY CURRENT vs TEMPERATURE IN ALS SENSING

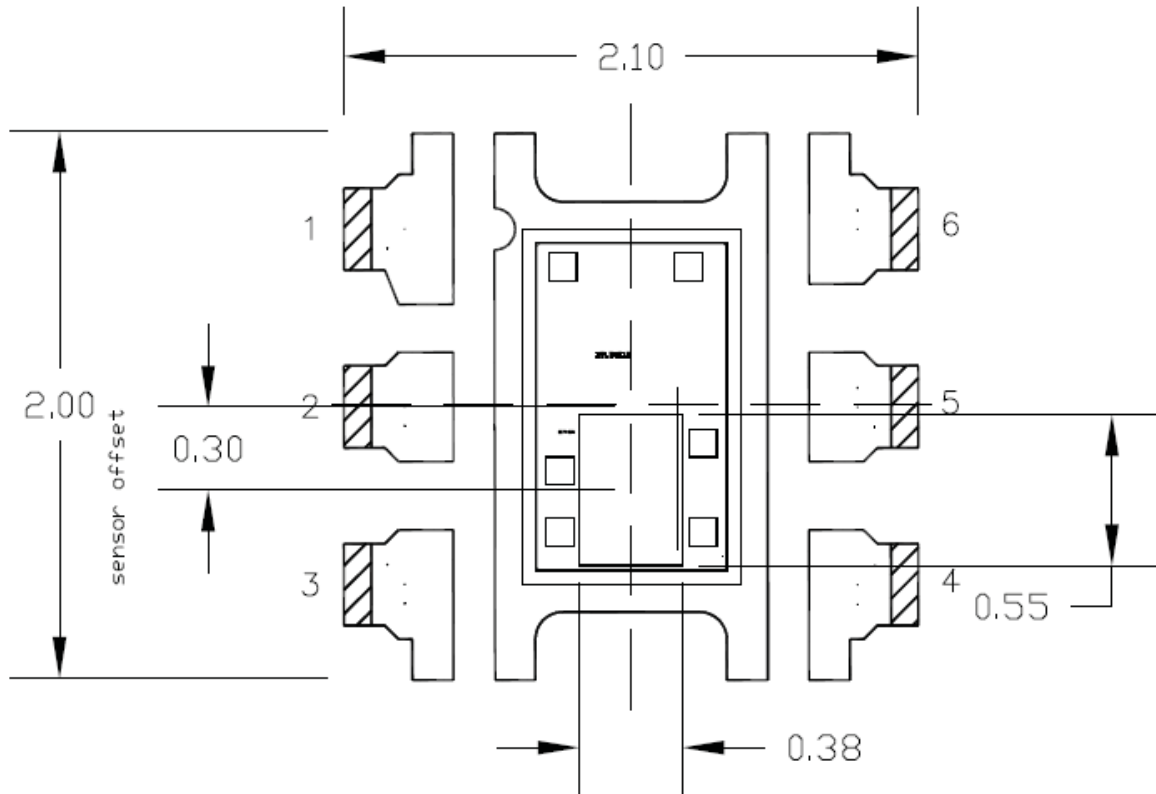

FIGURE 15. 6 LD ODFN SENSOR LOCATION OUTLINE

© Copyright Intersil Americas LLC 2008. All Rights Reserved.

All trademarks and registered trademarks are the property of their respective owners.

For additional products, see www.intersil.com/en/products.html

Intersil products are manufactured, assembled and tested utilizing ISO9001 quality systems as noted in the quality certifications found at www.intersil.com/en/support/qualandreliability.html

Intersil products are sold by description only. Intersil may modify the circuit design and/or specifications of products at any time without notice, provided that such modification does not, in Intersil's sole judgment, affect the form, fit or function of the product. Accordingly, the reader is cautioned to verify that datasheets are current before placing orders. Information furnished by Intersil is believed to be accurate and reliable. However, no responsibility is assumed by Intersil or its subsidiaries for its use; nor for any infringements of patents or other rights of third parties which may result from its use. No license is granted by implication or otherwise under any patent or patent rights of Intersil or its subsidiaries.

For information regarding Intersil Corporation and its products, see www.intersil.com

Package Outline Drawing

L6.2x2.1

6 LEAD OPTICAL DUAL FLAT NO-LEAD PLASTIC PACKAGE (ODFN)

Rev 0, 9/06

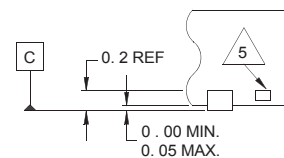
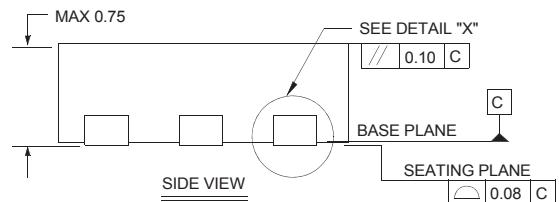
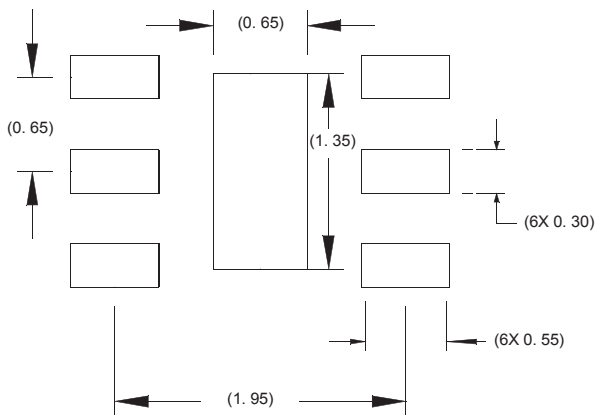
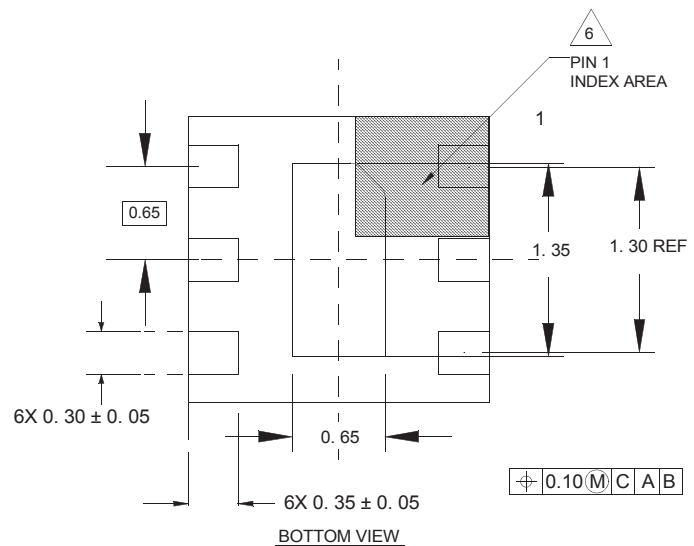
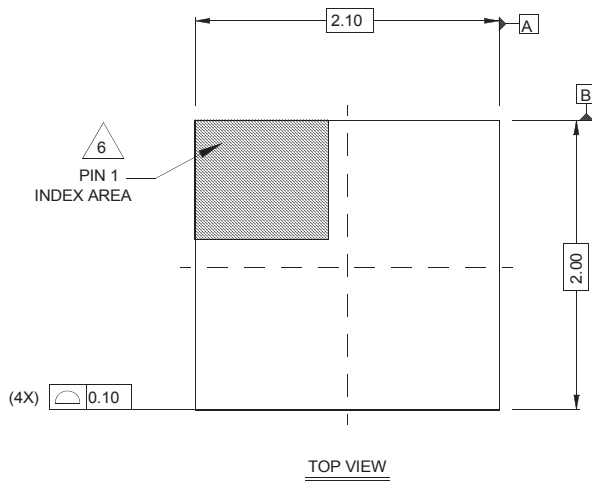

NOTES:

1. Dimensions are in millimeters.
Dimensions in () for Reference Only.
2. Dimensioning and tolerancing conform to AMSE Y14.5m-1994.
3. Unless otherwise specified, tolerance: Decimal ± 0.05
4. Dimension b applies to the metallized terminal and is measured between 0.15mm and 0.30mm from the terminal tip.
5. Tiebar shown (if present) is a non-functional feature.
6. The configuration of the pin #1 identifier is optional, but must be located within the zone indicated. The pin #1 identifier may be either a mold or mark feature.