

0.2mm Pitch

SERIES

6246

0.2mmピッチ RA SMT 上下千鳥接点 ワンタッチロック

0.2mmPitch RA SMT Dual-faced contact One-touch lock

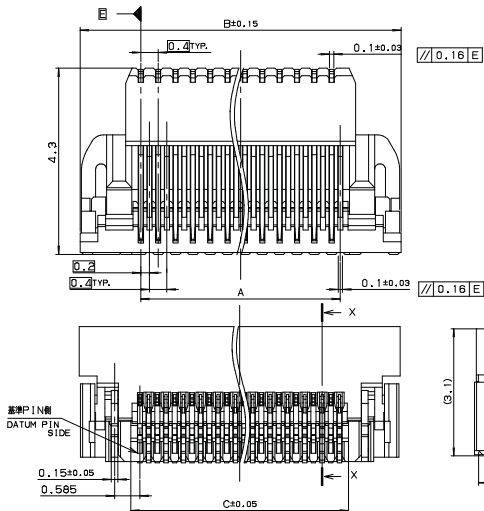

極数 NO. OF POS.	A	B	C
30	5.8	8.6	6.3
40	7.8	10.6	8.3
50	9.8	12.6	10.3
60	11.8	14.6	12.3
70	13.8	16.6	14.3
80	15.8	18.6	16.3

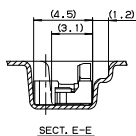
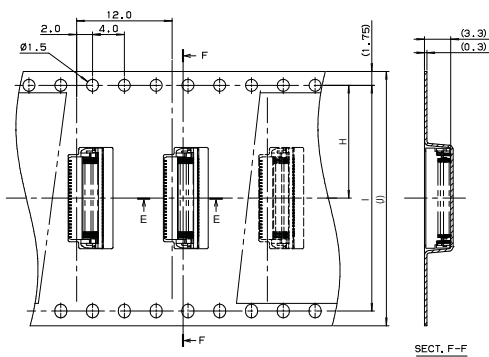
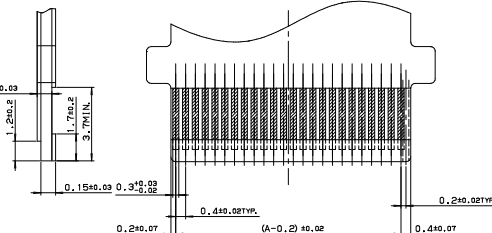
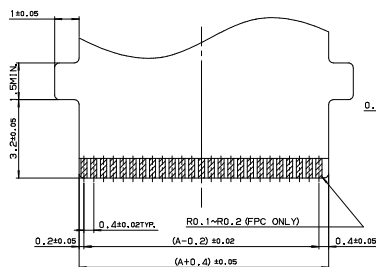
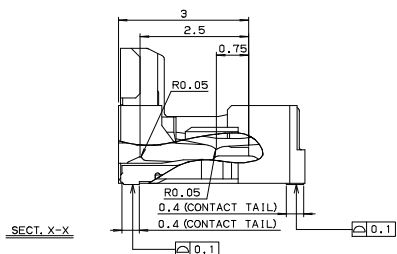
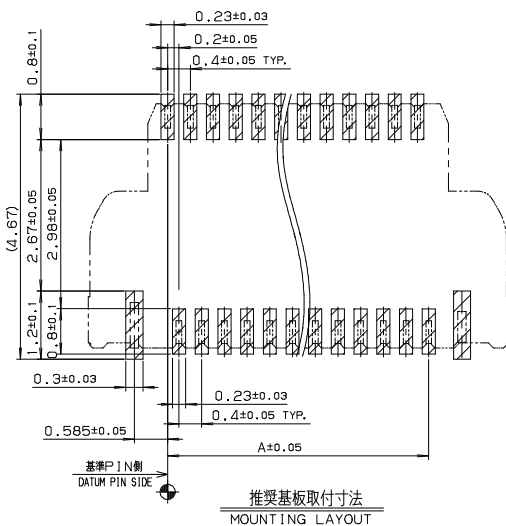

極数 NO. OF POS.	H	I	J
30	11.5	-	24.0
40	11.5	-	24.0
50	11.5	-	24.0
60	14.2	28.4	32.0
70	14.2	28.4	32.0
80	14.2	28.4	32.0

注文コード ORDERING CODE
04 6246 0XX 101 883+

極数 NUMBER OF POSITIONS

RoHS 対応品
RoHS Compliant Product

金めっき Au plated

生産対応可能極数については、営業部にご確認願います。

Feel free to contact our sales department for available numbers of positions.

梱包数量 2000個/リール
PACKING QUANTITY : 2000 /Reel