

AXL E IOL AO1 U M12 S

Axioline E IO-Link/analog converter for connecting an analog actuator, 0 V ... 10 V, straight version



Data sheet
8595_en_04

© PHOENIX CONTACT 2015-04-28

1 Description

The IO-Link/analog converter is an IO-Link slave that converts the IO-Link protocol into analog signals.

It therefore offers the option of transmitting signals to analog actuators via an IO-Link master.

Features

- Straight version
- 1 IO-Link interface
- 1 analog output
- Connection of the actuator in 3-wire technology
- Voltage range: 0 V ... 10 V
- IO-Link and actuator connections via M12 connectors
- FE connection for local connection to functional earth ground
- Supply of the module electronics and the actuator via the IO-Link interface of the IO-Link master
- Diagnostic indicator



Make sure you always use the latest documentation.
It can be downloaded from the product at phoenixcontact.net/products.

| | | |
|----------|--|----|
| 2 | Table of contents | |
| 1 | Description | 1 |
| 2 | Table of contents | 2 |
| 3 | Ordering data | 3 |
| 4 | Technical data | 3 |
| 5 | Additional tables | 5 |
| 6 | Internal circuit diagram | 5 |
| 7 | Pin assignment | 6 |
| | 7.1 Connections on the device | 6 |
| | 7.2 Pin assignment of the IO-Link interface | 6 |
| | 7.3 Pin assignment of the analog output | 6 |
| 8 | Connection notes | 6 |
| 9 | Connection example..... | 6 |
| 10 | Assembly..... | 7 |
| 11 | Local status indicator..... | 7 |
| 12 | Process data..... | 8 |
| | 12.1 IN process data | 8 |
| | 12.2 OUT process data..... | 9 |
| | 12.3 Parameterization via OUT process data | 9 |
| | 12.4 Example | 9 |
| 13 | Significant values in various formats..... | 10 |
| | 13.1 IB IL format | 10 |
| | 13.2 S7-compatible format | 10 |
| 14 | IO-Link objects | 11 |
| | 14.1 Overview of the objects | 11 |
| | 14.2 Parameterization (80 _{hex} : ParaWord) | 12 |

3 Ordering data

| Description | Type | Order No. | Pcs. / Pkt. |
|---|-----------------------|-----------|-------------|
| Axioline E IO-Link/analog converter for connecting an analog actuator, 0 V ... 10 V, M12 fast connection technology, straight version | AXL E IOL AO1 U M12 S | 2700350 | 1 |

4 Technical data

Dimensions (nominal sizes in mm)

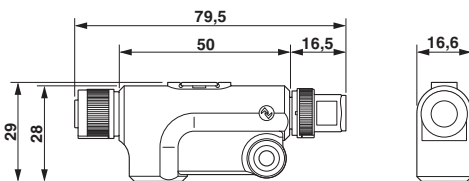

| | |
|--------|---------|
| Width | 16.6 mm |
| Height | 29 mm |
| Depth | 79.5 mm |

General data

| | |
|--|---|
| Weight | 34 g |
| Ambient temperature (operation) | -25 °C ... 60 °C |
| Ambient temperature (storage/transport) | -25 °C ... 85 °C |
| Permissible humidity (operation) | 5 % ... 95 % |
| Permissible humidity (storage/transport) | 5 % ... 95 % |
| Air pressure (operation) | 70 kPa ... 106 kPa (up to 3000 m above sea level) |
| Air pressure (storage/transport) | 70 kPa ... 106 kPa (up to 3000 m above sea level) |
| Degree of protection | IP65/67 |
| Protection class | III, IEC 61140, EN 61140, VDE 0140-1 |
| Pollution degree | 2 |

IO-Link

| | |
|--------------------------------------|---|
| Specification | V1.1.1 |
| Protection against polarity reversal | Yes |
| Transmission speed | 230,4 kBit/s (COM3) |
| Frame type | 1 |
| Cycle Time | min. 2 ms |
| Process data update | 2 ms |
| Amount of process data | 16 Bit (Input data), 16 Bit (Output data) |

IO-Link ports

| | |
|-------------------|------------------------|
| Number of ports | 1 |
| Connection method | M12 connector, A-coded |

IO-Link port supply

| | |
|--------------------------------------|---|
| Typical current consumption | 16.5 mA \pm 15% (at 24 V DC) |
| Current consumption | max. 135 mA |
| Protection against polarity reversal | Yes |
| Short-circuit protection | Yes |
| Overload protection | Yes |
| I/O supply voltage | 24 V DC This supply voltage is provided via the IO-Link interface of the IO-Link master. |
| Sensor supply voltage | 24 V DC (max. 100 mA) This supply voltage is provided via the I/O supply voltage. |

Analog output

| | |
|---------------------------------|---|
| Number of outputs | 1 (voltage) |
| Connection method | M12 connector, A-coded |
| Connection method | 3-conductor |
| Voltage output signal | 0 V ... 10 V |
| Load/output load voltage output | min. 10 k Ω |
| D/A resolution | 12 bit |
| Data formats | IB IL, S7-compatible |
| Precision | < 0.25 % (of output range final value in the nominal range) |
| Permissible cable length | max. 30 m (Shielded cable) |

Error messages to the higher level control or computer system

| | |
|-----------------------|--|
| Short circuit | Message in the diagnostic code (in the IB IL format) |
| Configuration invalid | Message in the diagnostic code (in the IB IL format) |
| Module faulty | Message in the diagnostic code (in the IB IL format) |

Mechanical tests

| | |
|--|---|
| Vibration resistance in acc. with EN 60068-2-6/IEC 60068-2-6 | Operation: 2g |
| Vibration resistance in acc. with EN 60068-2-6/IEC 60068-2-6 | Storage/transport: 5g |
| Shock in acc. with EN 60068-2-27/IEC 60068-2-27 | Operation: 30g, 11 ms, three shocks in each space direction |
| Shock in acc. with EN 60068-2-27/IEC 60068-2-27 | Storage/transport: 50g, 11 ms, three shocks in each space direction |
| Continuous shock according to EN 60068-2-27/IEC 60068-2-27 | 10g, 16 ms, 1000 shocks, in all space directions |

Approvals

For the latest approvals, please visit phoenixcontact.net/products.

5 Additional tables

The data is valid for nominal operation (supply voltage = 24 V) in the default configuration (measurement range 0 V ... 10 V).

| Tolerance and temperature response at $T_A = -25^\circ\text{C}$ to $+60^\circ\text{C}$ | |
|--|----------------|
| Drift | |
| Typical | Maximum |
| ± 25 ppm/K | ± 75 ppm/K |

The tolerance values refer to the measuring range final value.

| Tolerances influenced by electromagnetic interference | | | |
|---|--------------------------------|---------------|-----------|
| Type of electromagnetic interference | Standard | Tolerance | Criterion |
| Electromagnetic fields | EN 61000-4-3/ IEC 61000-4-3 | $< \pm 1.0\%$ | A |
| Fast transients (burst) | EN 61000-4-4/ IEC 61000-4-4 | $< \pm 1.0\%$ | A |
| Conducted interference | EN 61000-4-6/ IEC 61000-4-6 | $< \pm 1.0\%$ | A |

6 Internal circuit diagram

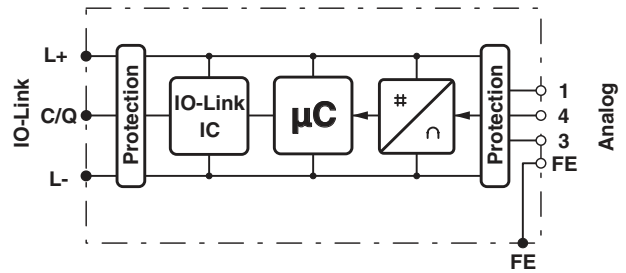
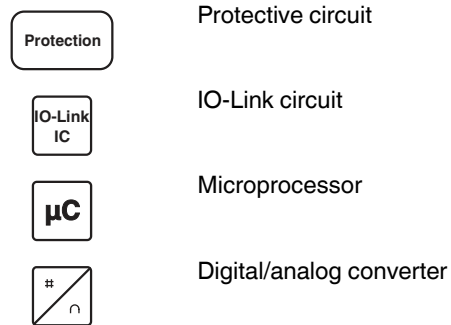

Figure 1 Internal wiring of connections

Key:



7 Pin assignment

7.1 Connections on the device

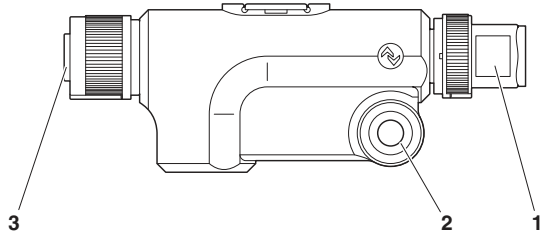

Figure 2 Connections on the converter

| No. | Connection |
|-----|---|
| 1 | IO-Link interface (indicated by IO-Link symbol) |
| 2 | Fixing options; options for connection to functional earth ground |
| 3 | Analog output |

7.2 Pin assignment of the IO-Link interface

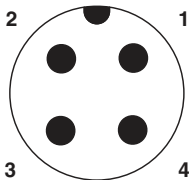

Figure 3 Pin assignment of the I/O link interface (M12 A-coded, pin)

| Pin | Signal | Meaning |
|-----|--------|---|
| 1 | L+ | +24 V supply voltage; from IO-Link master |
| 2 | - | Not used |
| 3 | L- | GND, reference potential for L+ |
| 4 | C/Q | IO-Link data transmission channel |

7.3 Pin assignment of the analog output

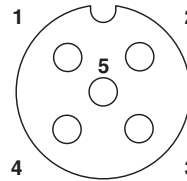

Figure 4 Pin assignment of the analog output (M12, A-coded, socket)

| Pin | Assignment |
|-----|-----------------------------|
| 1 | +24 V, 100 mA |
| 2 | Not used |
| 3 | GND |
| 4 | Voltage output 0 V ... 10 V |
| 5 | Not used |

8 Connection notes

Always connect the analog actuators using shielded twisted-pair cables.

9 Connection example

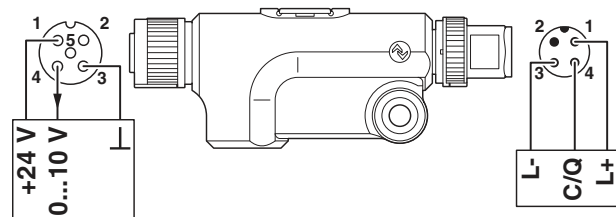

Figure 5 Connection example

10 Assembly

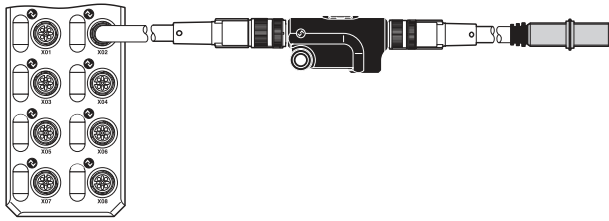

Figure 6 Connection of an actuator to an IO-Link master via the converter

- Connect the IO-Link interface of the converter to an IO-Link port of the higher-level IO-Link master using a standardized 3-pos. cable.
- Connect the analog actuator directly to the analog converter output or using a shielded 4-pos. cable.
- Fasten each connection using the M12 connectors.



In environments with high levels of interference, in particular, Phoenix Contact recommends connecting the converter to an appropriate functional earth ground point using an M4 screw.

11 Local status indicator

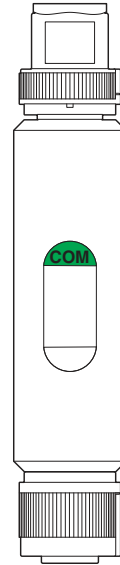

Figure 7 Local status indicator

| Designation | Color | Meaning | State | Description |
|-------------|-------|--------------------------|----------|--|
| COM | Green | Status of IO-Link device | ON | Supply voltage OK |
| | | | Flashing | Supply voltage OK, SDCI communication active |
| | | | OFF | No supply voltage, no communication |

12 Process data

The device occupies one word of IN process data and one word of OUT process data.

12.1 IN process data

The following data is transmitted in the input process data:

- During normal error-free operation, the output value is mirrored in the input process data for each channel.
- If an error occurs, the diagnostic message is mirrored in the input process data for each channel. The diagnostics message is deleted as soon as the error is eliminated.

Diagnostic messages in IB IL format

| Code (hex) | Cause |
|------------|---------------|
| 8001 | Overrange |
| 8003 | Short-circuit |
| 8040 | Device faulty |
| 8080 | Underrange |

Diagnostic messages in S7-compatible format

| Code (hex) | Cause |
|------------|--------------------------|
| 7FFF | Overrange |
| 8000 | Short-circuit/underrange |

12.2 OUT process data

The output values are depicted in IB IL or S7-compatible format.

For both formats the output value is represented in bits 14 to 3. Bit 15 is available as a sign bit. Bits 2 to 0 are not relevant for the output value.

| 15 | 14 | 13 | 12 | 11 | 10 | 9 | 8 | 7 | 6 | 5 | 4 | 3 | 2 | 1 | 0 |
|----|--------------|----|----|----|----|---|---|---|---|---|---|---|---|---|---|
| V | Analog value | | | | | | | | | | | x | x | x | |

V Sign bit (= 0, not relevant)

x Not relevant for the output value (must be 0)

Parameterization

In addition, the device can be parameterized via the process data output word.

The following configurations are possible:

- Selection of formats for representing measured values
- Establishing substitute value behavior

| 15 | 14 | 13 | 12 | 11 | 10 | 9 | 8 | 7 | 6 | 5 | 4 | 3 | 2 | 1 | 0 |
|---------------|----------|----|----|----|----|---|---|--|---|---|--------|---|----------|---|---|
| Configuration | Reserved | | | | | | | Substitute value behavior in the event that IO-Link communication is aborted | | | Format | | Reserved | | |



For the exact meaning of the individual bits, please refer to "Parameterization (80_{hex}: ParaWord)".



Output values in the range from 8000 ... BFFF are interpreted as parameter.

12.3 Parameterization via OUT process data

Reparameterization can be carried out via the output process data, however this is not saved permanently on the device.



Please operate the reparameterization only by the startup of the device!

The following sequence applies regardless of the format (IB IL or S7-compatible):

- The master interrupts the transmission of current process data and sends parameter data (OutputProcessData with bit 15 = 1)



In order to start configuration, bit 15 of the output word must be set to 1. If bit 15 = 0, the default configuration is active.

- The device interrupts the transmission of current process data and responds with the following diagnostic code in the process data:

| Code (hex) | Cause |
|------------|-----------------|
| 8800 | Parameter OK |
| 8801 | Parameter ERROR |

- If the diagnostic code is OK, the parameter data is accepted immediately. The master can end parameterization (OutputProcessData with bit 15 = 0). The device returns to normal operation with cyclic process data transmission.
- In the event of the ERROR diagnostic code, the master can abort parameterization without modified parameter data (OutputProcessData with bit 15 = 0) or transmit the modified parameterization (return to step 1).

12.4 Example

The example applies to the following changes:

- Selection of format S7-compatible (Default) to IB IL
- For "hold last value"

| 15 | 14 | 13 | 12 | 11 | 10 | 9 | 8 | 7 | 6 | 5 | 4 | 3 | 2 | 1 | 0 | |
|---------------|----------|----|----|----|----|---|---|--|---|---|--------|----------|----------|---|---|--|
| Configuration | Reserved | | | | | | | Substitute value behavior in the event that IO-Link communication is aborted | | | Format | | Reserved | | | |
| 1 | Reserved | | | | | | | 1 | 0 | 1 | 0 | Reserved | | | | |

13 Significant values in various formats

13.1 IB IL format

Resolution: 1 bit (0000 -> 0008) accords 2,67 V.

| Output data | | Range | 0 V ... 10 V |
|-------------|---------|-------------------------|--------------|
| hex | dec | | V |
| > 7F00 | > 32512 | Overrange | 10.837 |
| 7F00 | 32512 | Overdrive range (End) | 10.837 |
| 7538 | 30008 | Overdrive range (Start) | 10.00267 |
| 7530 | 30000 | Nominal range (End) | 10.0 |
| 3A98 | 15000 | Nominal range | 5.0 |
| 0008 | 8 | Nominal range | 0.00267 |
| 0000 | 0 | Nominal range (Start) | 0 |
| < 0000 | < 0 | Underrange | 0 |



This device cannot display voltage < 20 mV.
Values > 0020_{hex} are supported.



If overrange, input data 8001_{hex} is indicated.
If underrange, input data 8080_{hex} is indicated.
If short-circuit occurs, 0 V is issued and input data 8003_{hex} is indicated.

13.2 S7-compatible format

Resolution: 1 bit (0000 -> 0008) accords 2,89 mV.

| Output data | | Range | 0 V ... 10 V |
|-------------|---------|-------------------------|--------------|
| hex | dec | | V |
| > 7EF8 | > 32504 | Overrange | 0 |
| 7EF8 | 32504 | Overdrive range (End) | 11.756 |
| 6C08 | 27656 | Overdrive range (Start) | 10.00289 |
| 6C00 | 27648 | Nominal range (End) | 10.0 |
| 3600 | 13824 | Nominal range | 5.0 |
| 0008 | 8 | Nominal range | 0.00289 |
| 0000 | 0 | Nominal range (Start) | 0 |
| < 0000 | < 0 | Underdrive range | 0 |



The device cannot display voltage < 20 mV.
Values > 0018_{hex} are supported.



If overrange, input data 7FFF_{hex} is indicated.
If underrange, input data 8000_{hex} is indicated.
If short-circuit occurs, 0 V is issued and input data 8000_{hex} is indicated.

14 IO-Link objects

14.1 Overview of the objects

| Index (hex) | | Object name | Length in bytes | Access | Meaning | Contents |
|-----------------------|------|-------------------|-----------------|--------|-----------------------------|---|
| DPP | ISDU | | | | | |
| Identification | | | | | | |
| 07 | | Vendor ID | 2 | R | Manufacturer identification | 00 _{hex} |
| 08 | | | | | | B0 _{hex} |
| 09 | | Device ID | 3 | R | Device ID | 01 _{hex} |
| 0A | | | | | | 00 _{hex} |
| 0B | | | | | | 29 _{hex} |
| | 10 | VendorName | Max. 64 | R | Manufacturer name | Phoenix Contact |
| | 11 | VendorText | Max. 64 | R | Notes | www.phoenixcontact.com |
| | 12 | ProductName | Max. 64 | R | Product designation | AXL E IOL AO1 U M12 S |
| | 13 | Product ID | Max. 64 | R | Order No. | 2700350 |
| | 14 | ProductText | Max. 64 | R | Product text | IO-Link/Analog-Converter Voltage Output Straight |
| | 15 | Serial number | Max. 16 | R | Serial number | Stored in the production process. |
| | 16 | HardwareVersion | Max. 64 | R | Hardware version | E.g., 01 |
| | 17 | FirmwareVersion | Max. 64 | R | Firmware version | E.g., 001 |
| Diagnostics | | | | | | |
| | 20 | Error count | 2 | R | Errors since power up | Number of errors |
| | 29 | OutputProcessData | 2 | R | Output process data | Last current data |
| Parameter | | | | | | |
| | 80 | ParaWord | 2 | R/W | Parameterization | 0000 _{hex} |

| Abbreviation | Meaning |
|--------------|---------|
| R | Read |
| W | Write |

14.2 Parameterization (80_{hex}: ParaWord)

Parameterize the device using this object.

In the case of valid parameters, the parameterization is permanently stored on the device.

After a reset, the device operates with the last permanently stored data. Upon delivery, the device operates with the default data (default settings).



Saving data to the device leads to a communication failure of around 30 ms.

| 15 | 14 | 13 | 12 | 11 | 10 | 9 | 8 | 7 | 6 | 5 | 4 | 3 | 2 | 1 | 0 |
|----------|----|----|----|----|----|---|---|--|--------|----------|---|---|---|---|---|
| Reserved | | | | | | | | Substitute value behavior in the event that IO-Link communication is aborted | Format | Reserved | | | | | |

In the following tables the values in **bold** are default settings.

| Format | |
|------------|----------------------|
| Code (bin) | Meaning |
| 00 | S7-compatible |
| 10 | IB IL |
| Other | Reserved |

| Substitute value behavior in the event that IO-Link communication is aborted | |
|--|---|
| Code (bin) | Meaning |
| 00 | Output of zero value (0 V) at output |
| 01 | Output of final value (10 V) at output |
| 10 | Hold last value |
| 11 | Reserved |
| Other | Reserved |