

IRFP244, IRFP245 IRFP246, IRFP247

N-Channel Power MOSFETs
Avalanche Energy Rated

August 1991

Features

- 15A and 14A, 275V - 250V
- $r_{DS(on)} = 0.28\Omega$ and 0.34Ω
- Single Pulse Avalanche Energy Rated
- SOA is Power-Dissipation Limited
- Nanosecond Switching Speeds
- Linear Transfer Characteristics
- High Input Impedance
- 275V, 250V DC Rated - 120V AC Line System Operation

Description

The IRFP244, IRFP245, IRFP246, and IRFP247 are advanced power MOSFETs designed, tested and guaranteed to withstand a specified level of energy in the breakdown avalanche mode of operation. These are n-channel enhancement-mode silicon-gate power field-effect transistors designed for applications such as switching regulators, switching converters, motor drivers, relay drivers, and drivers for high-power bipolar switching transistors requiring high speed and low gate-drive power. These types can be operated directly from integrated circuits.

The IRFP types are supplied in the JEDEC TO-247 plastic package.

Package

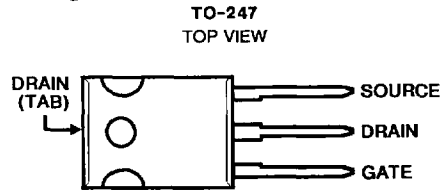

Terminal Diagram

N-CHANNEL ENHANCEMENT MODE

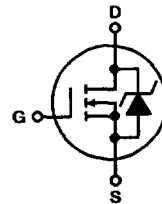

Absolute Maximum Ratings ($T_C = +25^\circ\text{C}$), Unless Otherwise Specified

	IRFP244	IRFP245	IRFP246	IRFP247	UNITS	
Drain-Source Voltage (1)	V_{DS}	250	250	275	275	V
Drain-Gate Voltage ($R_{GS} = 20k\Omega$) (1)	V_{DGR}	250	250	275	275	V
Continuous Drain Current						
$T_C = +25^\circ\text{C}$	I_D	15	14	15	14	A
$T_C = +100^\circ\text{C}$	I_D	9.7	8.8	9.7	8.8	A
Pulsed Drain Current (3)	I_{DM}	60	56	60	56	A
Gate-Source Voltage	V_{GS}	± 20	± 20	± 20	± 20	V
Maximum Power Dissipation						
$T_C = +25^\circ\text{C}$	P_D	150	150	150	150	W
Linear Derating Factor		1.2	1.2	1.2	1.2	W/ $^\circ\text{C}$
Single Pulse Avalanche Energy Rating (4)	E_{AS}	550	550	550	550	mJ
Operating and Storage Junction	T_J, T_{STG}	-55 to +150	-55 to +150	-55 to +150	-55 to +150	$^\circ\text{C}$
Temperature Range						
Maximum Lead Temperature for Soldering	T_L	300	300	300	300	$^\circ\text{C}$
(0.063" (1.6mm) from case for 10s)						

NOTES:

1. $T_J = +25^\circ\text{C}$ to $+150^\circ\text{C}$.
2. Pulse Test: Pulse width $\leq 300\mu\text{s}$, Duty Cycle $\leq 2\%$.
3. Repetitive Rating: Pulse width limited by max. junction temperature. See Transient Thermal Impedance Curve (Figure 5).
4. $V_{DD} = 50\text{V}$, starting $T_J = +25^\circ\text{C}$, $L = 4.0\text{mH}$, $R_{GS} = 25\Omega$, $I_{PEAK} = 15\text{A}$. See Figures 14 and 15.

Specifications IRFP244, IRFP245, IRFP246, IRFP247

Electrical Characteristics $T_C = +25^\circ\text{C}$, Unless Otherwise Specified

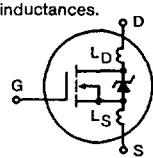
CHARACTERISTIC	SYMBOL	TEST CONDITIONS	LIMITS			UNITS	
			MIN	TYP	MAX		
Drain-Source Breakdown Voltage IRFP244, IRFP245 IRFP246, IRFP247	BV_{DSS}	$V_{GS} = 0V, I_D = 250\mu A$	250	-	-	V	
			275	-	-	V	
Gate Threshold Voltage	$V_{GS(TH)}$	$V_{DS} = V_{GS}, I_D = 250\mu A$	2.0	-	4.0	V	
Gate-Source Leakage Forward	I_{GSS}	$V_{GS} = 20V$	-	-	500	nA	
Gate-Source Leakage Reverse	I_{GSS}	$V_{GS} = -20V$	-	-	-500	nA	
Zero Gate Voltage Drain Current	I_{DSS}	$V_{DS} = \text{Max Rating}, V_{GS} = 0V$	-	-	250	μA	
		$V_{DS} = \text{Max Rating} \times 0.8, V_{GS} = 0V, T_C = +125^\circ\text{C}$	-	-	1000	μA	
On-State Drain Current (Note 2) IRFP244, IRFP246 IRFP245, IRFP247	$I_{D(ON)}$	$V_{DS} > I_{D(ON)} \times r_{DS(ON)} \text{ Max}, V_{GS} = 10V$	15	-	-	A	
			14	-	-	A	
Static Drain-Source On-State Resistance (Note 2) IRFP244, IRFP246 IRFP245, IRFP247	$r_{DS(ON)}$	$V_{GS} = 10V, I_D = 10A$	-	0.20	0.28	Ω	
			-	0.24	0.34	V	
Forward Transconductance (Note 2)	g_{fs}	$V_{DS} \geq 50V, I_D = 10A$	6.7	11	-	S(Ω)	
Input Capacitance	C_{ISS}	$V_{GS} = 0V, V_{DS} = 25V, f = 1.0\text{MHz}$	-	1300	-	pF	
Output Capacitance	C_{OSS}	See Figure 10	-	320	-	pF	
Reverse Transfer Capacitance	C_{RSS}		-	69	-	pF	
Turn-On Delay Time	$t_{d(ON)}$	$V_{DD} = 125V, I_D = 15A, R_G = 9.1\Omega$, See Figure 16. (MOSFET switching times are essentially independent of operating temperature)	-	16	24	ns	
Rise Time	t_r		-	67	100	ns	
Turn-Off Delay Time	$t_{d(OFF)}$		-	53	80	ns	
Fall Time	t_f		-	49	74	ns	
Total Gate Charge (Gate-Source + Gate-Drain)	Q_g		$V_{GS} = 10V, I_D = 15A, V_{DS} = 0.8 \text{ Max Rating}$. See Figure 17 for test circuit. (Gate charge is essentially independent of operating temperature.)	-	39	59	nC
Gate-Source Charge	Q_{gs}		-	6.6	-	nC	
Gate-Drain ("Miller") Charge	Q_{gd}		-	20	-	nC	
Internal Drain Inductance	L_D	Measured from the drain lead, 6mm (0.25") from package to center of die.	Modified MOSFET symbol showing the internal device inductances.		-	5.0	nH
Internal Source Inductance	L_S	Measured from the source lead, 6mm (0.25") from package to source bonding pad.			-	12.5	nH
Junction-to-Case	$R_{\theta JC}$		-	-	0.83	$^\circ\text{C/W}$	
Case-to-Sink	$R_{\theta CS}$	Mounting surface flat, smooth and greased	-	0.1	-	$^\circ\text{C/W}$	
Junction-to-Ambient	$R_{\theta JA}$	Free air operation	-	-	30	$^\circ\text{C/W}$	

Source Drain Diode Ratings and Characteristics

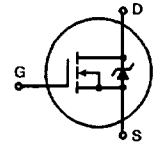
Continuous Source Current (Body Diode)	I_S	Modified MOSFET symbol showing the integral reverse P-N junction rectifier.		-	-	15	A
Pulse Source Current (Body Diode) (Note 3)	I_{SM}			-	-	60	A
Diode Forward Voltage (Note 2)	V_{SD}	$T_J = +25^\circ\text{C}, I_S = 15A, V_{GS} = 0V$	-	-	1.8	V	
Reverse Recovery Time	t_{rr}	$T_J = +25^\circ\text{C}, I_F = 14A, di_F/dt = 100A/\mu s$	150	300	640	ns	
Reverse Recovered Charge	Q_{RR}	$T_J = +25^\circ\text{C}, I_F = 14A, di_F/dt = 100A/\mu s$	1.6	3.4	7.2	μC	
Forward Turn-on Time	t_{ON}	Intrinsic turn-on time is negligible. Turn-on speed is substantially controlled by $L_S + L_D$.	-	-	-	-	

NOTES: 1. $T_J = +25^\circ\text{C}$ to $+150^\circ\text{C}$

2. Pulse Test: Pulse width $\leq 300\mu s$,
Duty Cycle $\leq 2\%$

3. Repetitive Rating: Pulse width limited by max. junction temperature. See Transient Thermal Impedance Curve (Figure 5)

4. $V_{DD} = 50V$, Start $T_J = +25^\circ\text{C}$, $L = 4.0\text{mH}$,
 $R_{GS} = 25\Omega$, $I_{PEAK} = 15A$.
(See Figures 14 & 15)

IRFP244, IRFP245, IRFP246, IRFP247

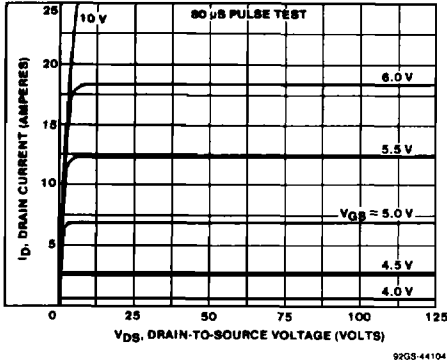

Fig. 1 - Typical output characteristics.

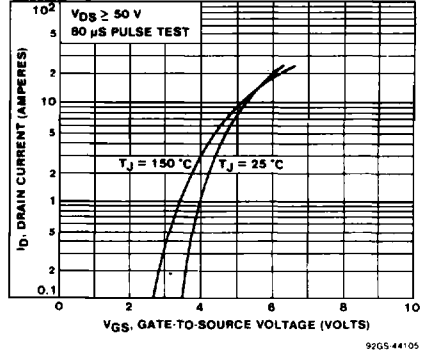

Fig. 2 - Typical transfer characteristics.

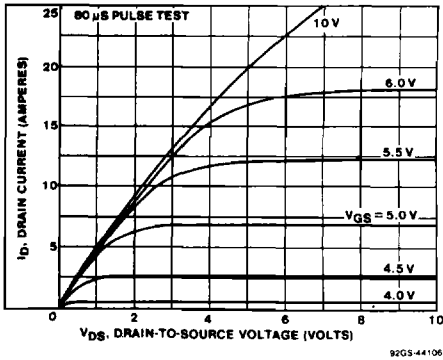

Fig. 3 - Typical saturation characteristics.

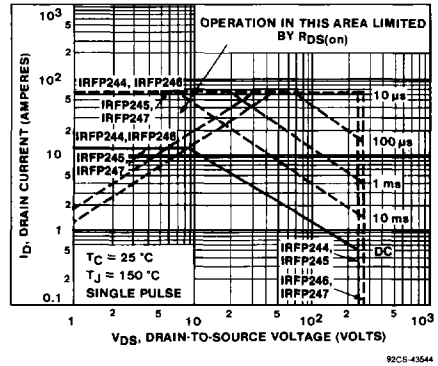

Fig. 4 - Maximum safe operating area.

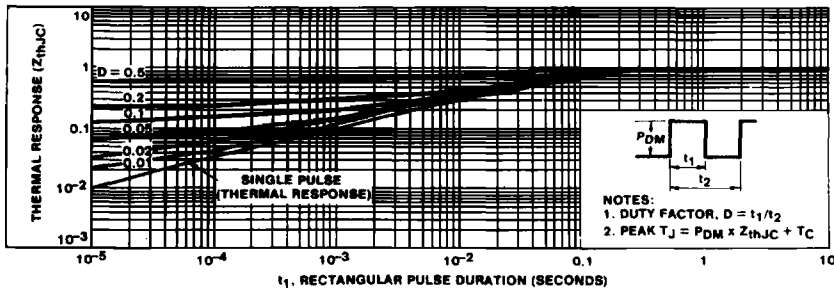

Fig. 5 - Maximum effective transient thermal impedance, junction-to-case vs. pulse duration.

4

N-CHANNEL
POWER MOSFETS

IRFP244, IRFP245, IRFP246, IRFP247

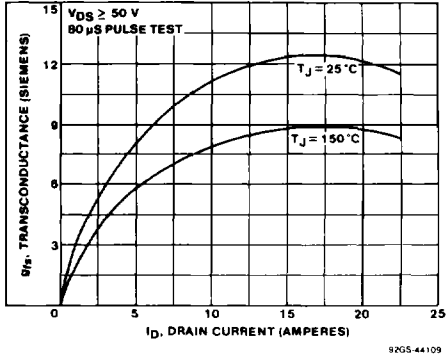

Fig. 6 - Typical transconductance vs. drain current.

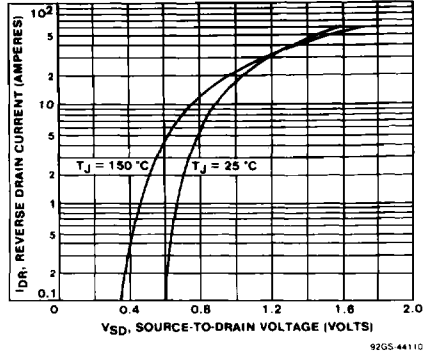

Fig. 7 - Typical source-drain diode forward voltage.

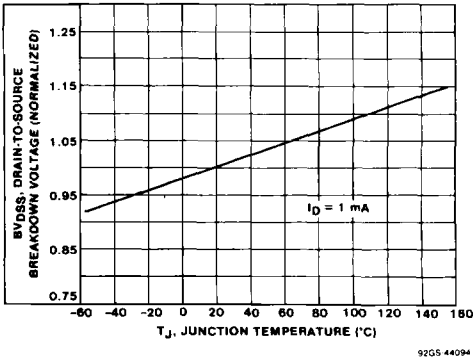

Fig. 8 - Breakdown voltage vs. temperature.

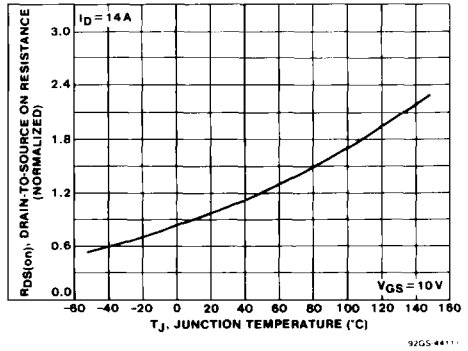

Fig. 9 - Normalized on-resistance vs. temperature.

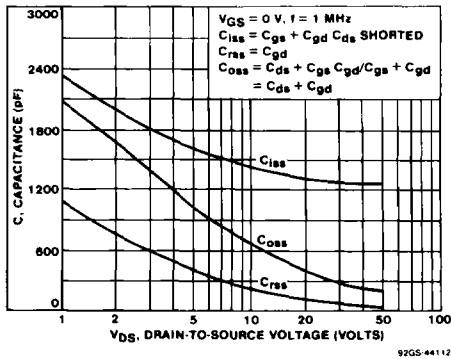

Fig. 10 - Typical capacitance vs. drain-to-source voltage.

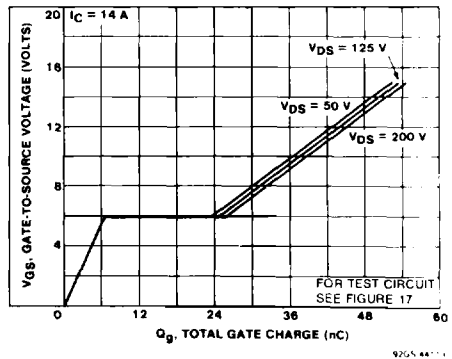

Fig. 11 - Typical gate charge vs. gate-to-source voltage.

IRFP244, IRFP245, IRFP246, IRFP247

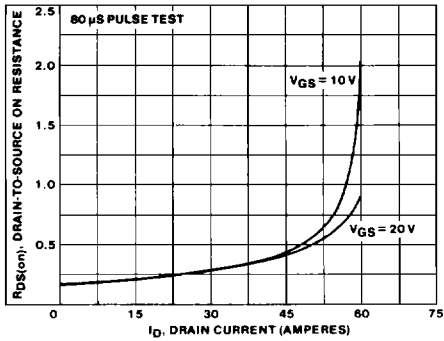

Fig. 12 - Typical on-resistance vs. drain current.

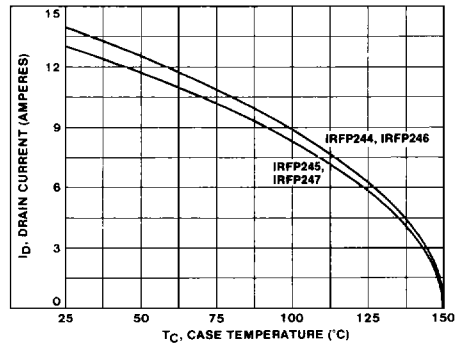

Fig. 13 - Maximum drain current vs case temperature.

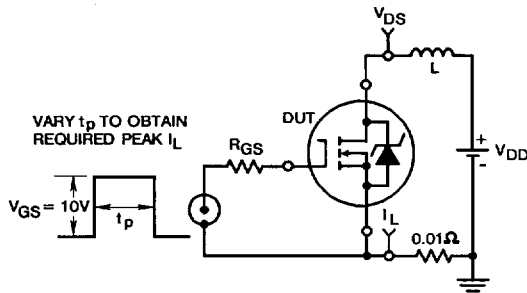

Fig. 14 - Unclamped energy test circuit.

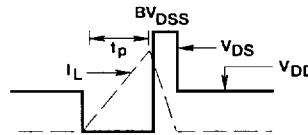

Fig. 15 - Unclamped energy waveforms.

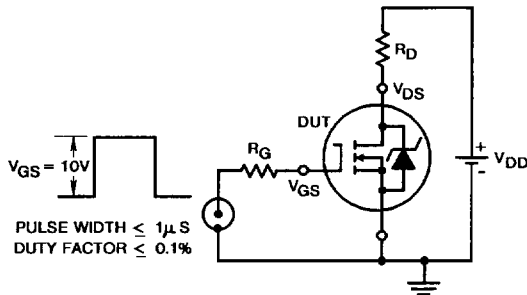

Fig. 16 - Switching time test circuit.

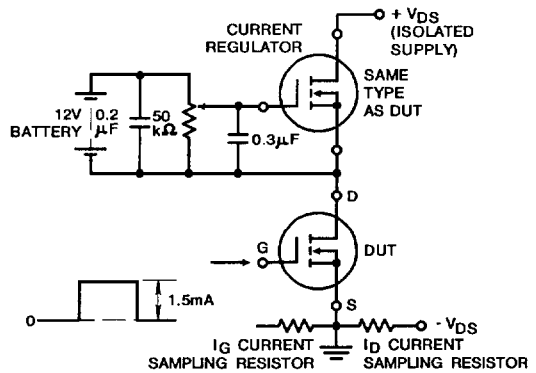

Fig. 17 - Gate charge test circuit.