

4-794632-0 ✓ ACTIVE

MATE-N-LOK | Micro MATE-N-LOK

TE Internal #: 4-794632-0

Rectangular Power Connectors, Header, Plug, Wire-to-Board, 10
Position, 3 mm [.118 in] Centerline, Printed Circuit Board, UL 94V-0,
Micro MATE-N-LOK

[View on TE.com >](#)



Connectors > Power Connectors > Rectangular Power > Rectangular Power Connectors

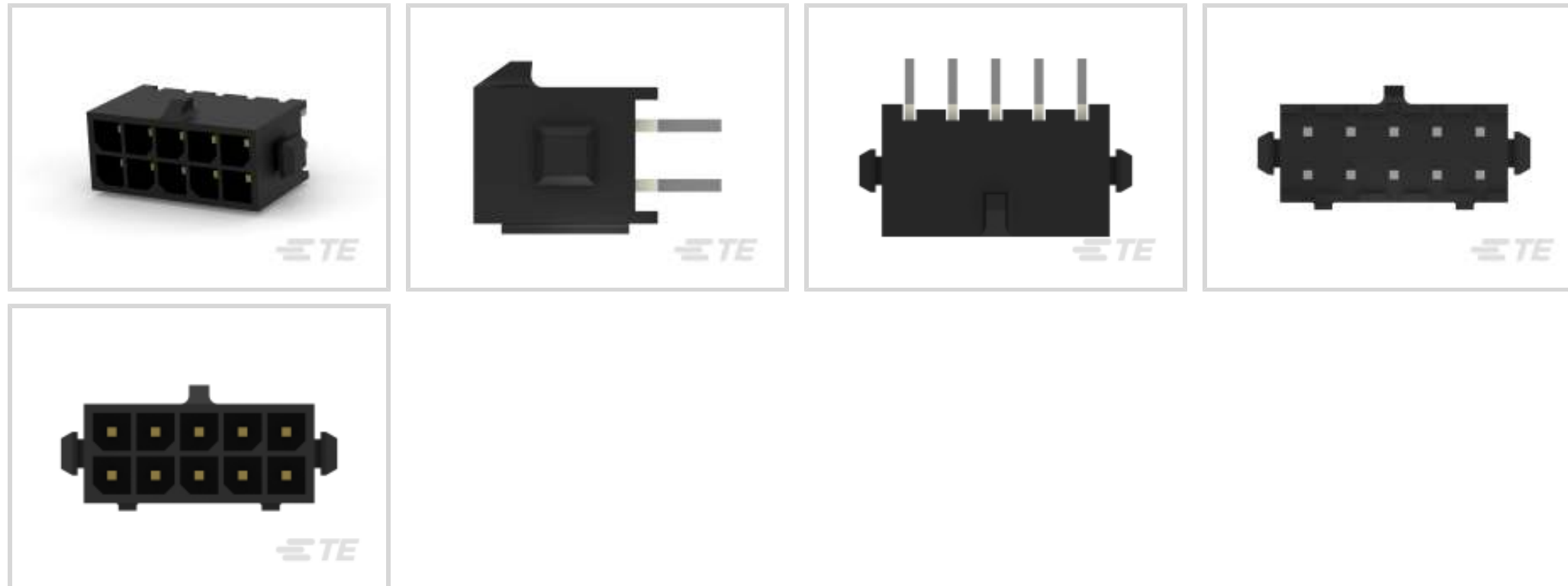

Rectangular Power Connector Type: **Header**

Connector & Housing Type: **Plug**

Connector System: **Wire-to-Board**

Number of Positions: **10**

Centerline (Pitch): **3 mm [.118 in]**

Features

Product Type Features

Header Type	Fully Shrouded
Rectangular Power Connector Type	Header
Connector & Housing Type	Plug
Connector System	Wire-to-Board
Sealable	No
Connector & Contact Terminates To	Printed Circuit Board

Configuration Features

Number of Positions	10
PCB Mount Orientation	Vertical
Number of Power Positions	10
Number of Rows	2

Electrical Characteristics

Operating Voltage	250 VDC
-------------------	---------

Contact Features



Multiple Contact Types	Without
PCB Contact Termination Area Plating Material Thickness	3.81 μm [150 μin]
Contact Mating Area Plating Material	Gold
Contact Current Rating (Max)	5 A
Contact Retention Within Housing	Without
Contact Type	Pin
PCB Contact Termination Area Plating Material	Tin
Contact Mating Area Plating Material Thickness	.76 μm [30 μin]

Termination Features

Termination Post & Tail Length	3.43 mm[.135 in]
Termination Method to Printed Circuit Board	Through Hole - Solder

Mechanical Attachment

Mating Alignment Type	Polarization
Mating Retention	With
Mating Alignment	With
PCB Mount Alignment	Without
Panel Mount Feature	Without
PCB Mount Retention	With
PCB Mount Retention Type	Retention Bump
Mating Retention Type	Locking Tab
Connector Mounting Type	Board Mount

Housing Features

PCB Mount Retention Material	Phosphor Bronze
Centerline (Pitch)	3 mm[.118 in]
Housing Color	Black
Housing Material	Nylon

Dimensions

Compatible Insulation Diameter (Max)	1.52 mm
Connector Height	8.67 mm
PCB Thickness (Recommended)	1.6 mm[.063 in]
Product Width	9.24 mm
Product Length	19 mm



Row-to-Row Spacing	3 mm [.118 in]
--------------------	----------------

Usage Conditions

Operating Temperature Range	-40 – 105 °C [-40 – 221 °F]
-----------------------------	-----------------------------

Operation/Application

Circuit Application	Power
---------------------	-------

Industry Standards

CSA Rating	Certified, LR 7189
------------	--------------------

Glow Wire Material Rating	Material with GWFI 850°C, Material with GWIT ≥ 775°C
---------------------------	--

UL Rating	Recognized
-----------	------------

Agency/Standard	CNR, USR
-----------------	----------

Approved Standards	UL E28476
--------------------	-----------

UL Flammability Rating	UL 94V-0
------------------------	----------

Glow Wire Rating	GWT 750°C (Without Flame)
------------------	---------------------------

Packaging Features

Packaging Quantity	195
--------------------	-----

Packaging Method	Box & Tray, Tray
------------------	------------------

Product Compliance

[For compliance documentation, visit the product page on TE.com>](#)

EU RoHS Directive 2011/65/EU	Compliant
------------------------------	-----------

EU ELV Directive 2000/53/EC	Compliant
-----------------------------	-----------

China RoHS 2 Directive MIIT Order No 32, 2016	No Restricted Materials Above Threshold
---	---

EU REACH Regulation (EC) No. 1907/2006	Current ECHA Candidate List: JUNE 2023 (235) Candidate List Declared Against: JUNE 2023 (235) Does not contain REACH SVHC
--	---

Halogen Content	Low Halogen - Br, Cl, F, I < 900 ppm per homogenous material. Also BFR/CFR/PVC Free
-----------------	---

Solder Process Capability	Reflow solder capable to 260°C
---------------------------	--------------------------------

Product Compliance Disclaimer

This information is provided based on reasonable inquiry of our suppliers and represents our current actual knowledge based on the information they provided. This information is subject to change. The part numbers that TE has identified as EU RoHS compliant have a maximum concentration of 0.1% by weight in homogenous materials for lead, hexavalent



chromium, mercury, PBB, PBDE, DBP, BBP, DEHP, DIBP, and 0.01% for cadmium, or qualify for an exemption to these limits as defined in the Annexes of Directive 2011/65/EU (RoHS2). Finished electrical and electronic equipment products will be CE marked as required by Directive 2011/65/EU. Components may not be CE marked. Additionally, the part numbers that TE has identified as EU ELV compliant have a maximum concentration of 0.1% by weight in homogenous materials for lead, hexavalent chromium, and mercury, and 0.01% for cadmium, or qualify for an exemption to these limits as defined in the Annexes of Directive 2000/53/EC (ELV). Regarding the REACH Regulation, the information TE provides on SVHC in articles for this part number is based on the latest European Chemicals Agency (ECHA) 'Guidance on requirements for substances in articles' posted at this URL: <https://echa.europa.eu/guidance-documents/guidance-on-reach>

Compatible Parts



TE Part # 1-794617-0
10POS,MICRO MNL,RCPT HSG

Also in the Series | Micro MATE-N-LOK



Insertion & Extraction Tools(1)



Power Contacts(27)



Rectangular Power Connectors(466)

Customers Also Bought



TE Part #1-5645956-1
SOCKET,MIN-SPR B-N SN-SN SER-2



TE Part #4-794632-6
16P MICRO MNL ASSY,VRT,HDR,LF

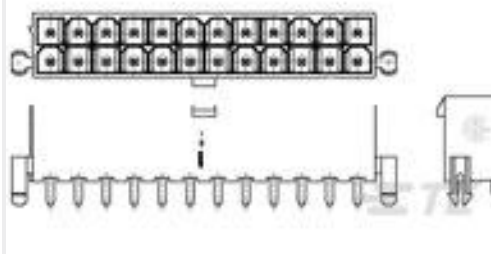

TE Part #1-1586039-2
12P VAL-U-LOK VRT HDR W/P V2



TE Part #3-794632-4
04P MICRO MNL ASSY,VRT,HDR,LF

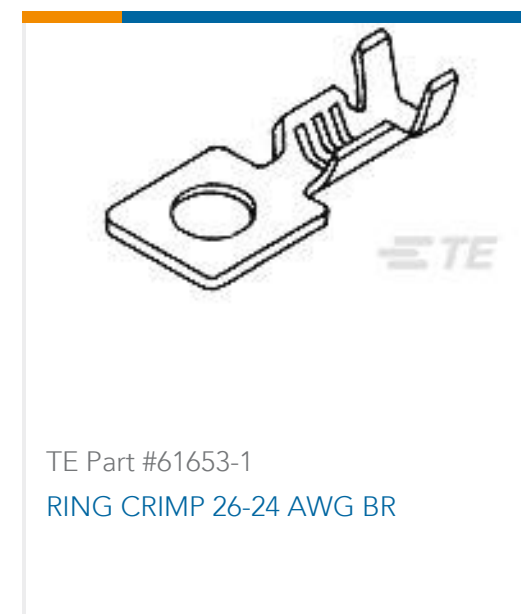
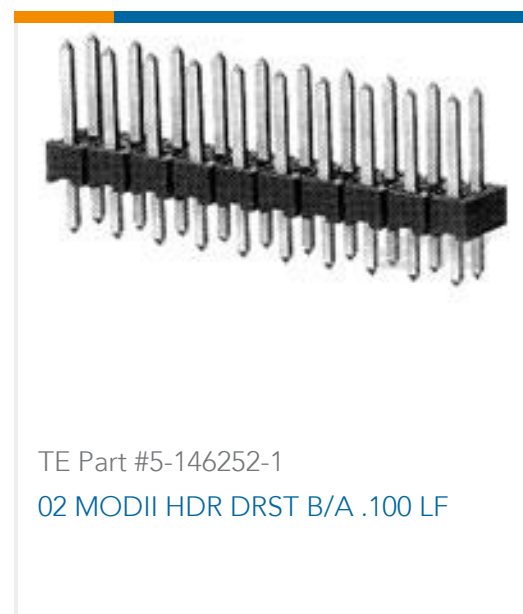

Documents

Product Drawings

10P MICRO MNL ASSY,VRT,HDR,LF

English

CAD Files

3D PDF

3D

Customer View Model

[ENG_CVM_CVM_4-794632-0_G.2d_dxf.zip](#)

English

Customer View Model

[ENG_CVM_CVM_4-794632-0_G.3d_igs.zip](#)

English

Customer View Model

[ENG_CVM_CVM_4-794632-0_G.3d_stp.zip](#)

English

By downloading the CAD file I accept and agree to the [Terms and Conditions](#) of use.

Datasheets & Catalog Pages

SOFT_SHELL_PIN_AND_SOCKET_CONNECTORS_CATALOG

English

MICRO MATE-N-LOK CONNECTOR SYSTEM

English

Product Specifications

Application Specification

English



Product Environmental Compliance

Product Compliance Document

English

Product Compliance Document

English

Agency Approvals

VDE Certificate

English