



## Parts Directory

### Welding Helmets (non-respiratory models)

<b>3M™ Speedglas™ Welding Helmet 9100</b>	<b>3</b>
<b>3M™ Speedglas™ Welding Helmet 9100 FX</b>	<b>4</b>
<b>3M™ Speedglas™ Welding Helmets 100 Series</b>	<b>6</b>
<b>3M™ Speedglas™ Welding Helmet SL</b>	<b>7</b>
<b>3M™ Speedglas™ Welding Helmet FlexView</b>	<b>7</b>
<b>3M™ Speedglas™ Welding Helmet 9000/Utility</b>	<b>8</b>
<b>3M™ Speedglas™ Welding Helmet 9000 ProTop (with hard hat)</b>	<b>9</b>
<b>Hard Hat Options for 3M™ Speedglas™ Welding Helmet 9100 / 100 / SL</b>	<b>9</b>

### Respiratory Protection

<b>3M™ Adflo™ Powered Air Purifying Respirator</b>	<b>11</b>
<b>3M™ Fresh-air III Supplied Air System</b>	<b>12</b>
<b>3M™ Fresh-air II Supplied Air System</b>	<b>12</b>
<b>3M™ Compressed Air Filter and Regulator Panels</b>	<b>13</b>

### Headtops for Respiratory Protection

<b>3M™ Speedglas™ Welding Helmet 9100-Air</b>	<b>14</b>
<b>3M™ Speedglas™ Welding Helmet 9100 FX-Air</b>	<b>15</b>
<b>3M™ Speedglas™ Welding Helmet 9000 Series</b>	<b>16</b>
<b>3M™ Speedglas™ Welding Helmet L-Series</b>	<b>17</b>
<b>3M™ ClearVisor with Adflo™ PAPR</b>	<b>18</b>

<b>Care and Maintenance</b>	<b>19</b>
-----------------------------	-----------

# 3M™ Speedglas™ Welding Helmet — Product Overview

The Speedglas auto-darkening welding filter was one of the first of its type on the market, bringing a new standard to eye protection and comfort for welders.

Today, there is a great family of Speedglas welding helmets, each model with its specific series of welding filters:

## Welding Helmets

## Auto-Darkening Welding Filters

## Accessories

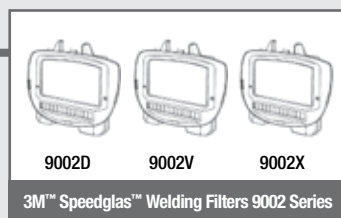
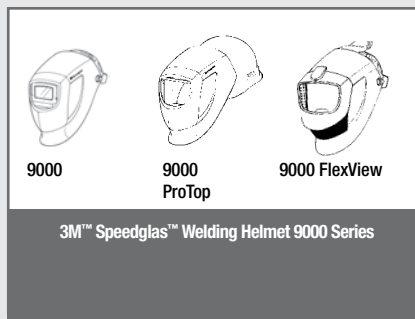
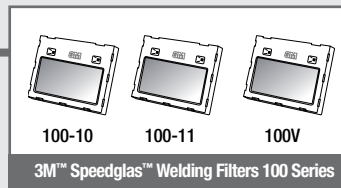
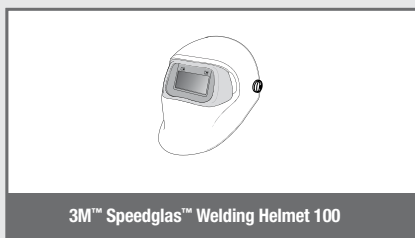
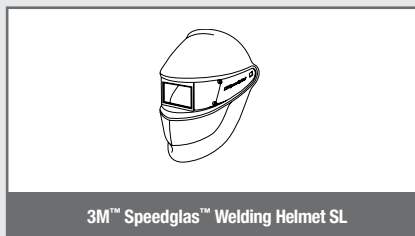
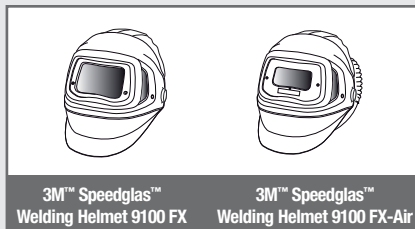
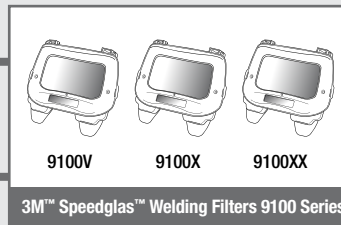
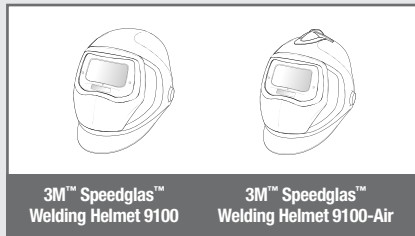

Every welder is different, and each day a welder's tasks can change. As owner of a Speedglas welding helmet, you have a variety of accessories available to help increase your protection and comfort.

The following pages list virtually all of the Speedglas replacement parts and available accessories.



# 3M™ Speedglas™ Welding Helmet 9100



Part No	Description	Part No	Description	Part No	Description
06-0100-10	Speedglas Helmet 9100 with 9100V ADF.	06-0100-20	Speedglas Helmet 9100 with 9100X ADF.	06-0100-30	Speedglas Helmet 9100 with 9100XX ADF.
06-0100-10SW	Speedglas Helmet 9100 with SideWindows and 9100V ADF.	06-0100-20SW	Speedglas Helmet 9100 with SideWindows and 9100X ADF.	06-0100-30SW	Speedglas Helmet 9100 with SideWindows and 9100XX ADF.

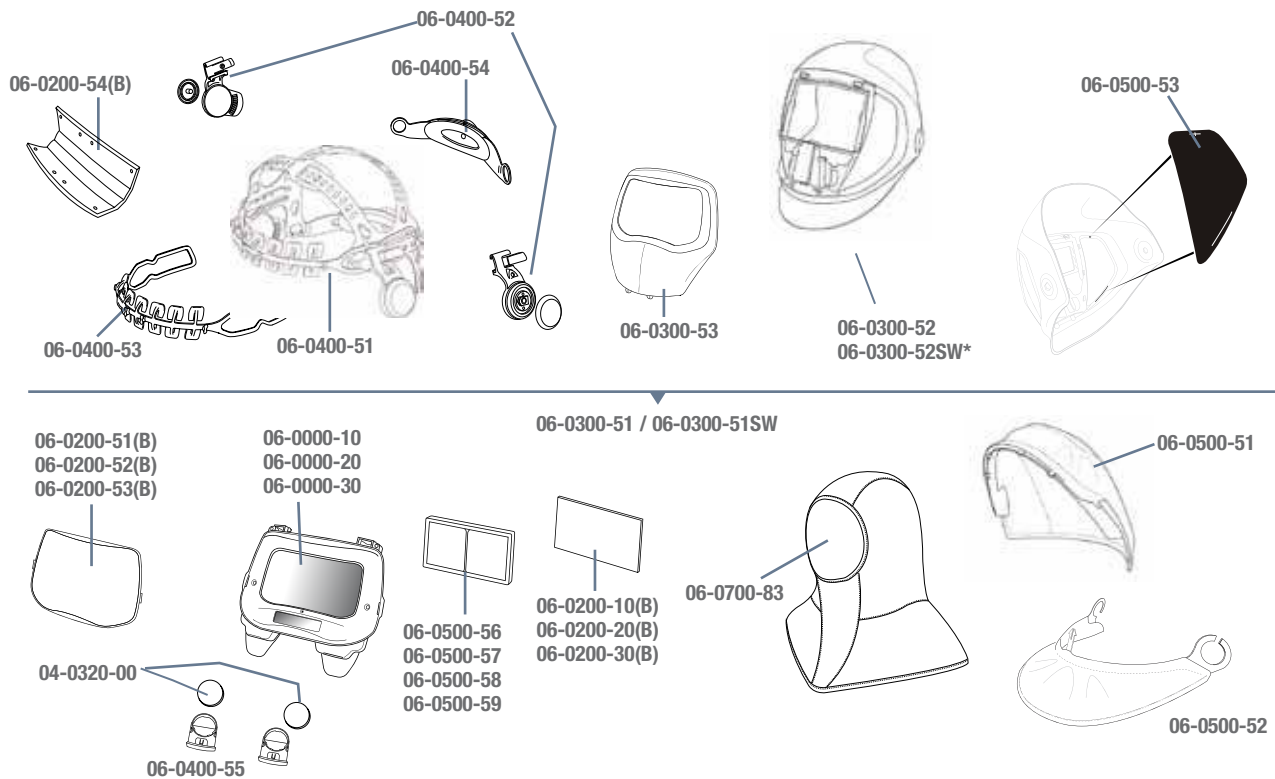

## Accessories and consumables

Part No	Description	Part No	Description	Part No	Description
04-0320-00	Batteries	06-0200-53	Outside protection plate high temperature, 10/case	06-0300-52SW*9100 Helmet with SideWindows, without headband and silver front panel	
06-0000-10	Speedglas 9100V ADF, variable shade 5, 8, 9-13	06-0200-53-B	Outside protection plate high temperature, 50/case	06-0300-53	9100 silver front panel
06-0000-20	Speedglas 9100X ADF, variable shade 5, 8, 9-13	06-0200-54	Comfort sweatband, 3/case	06-0400-51	9100 headband incl assembled parts.
06-0000-30	Speedglas 9100XX ADF, variable shade 5, 8, 9-13	06-0200-54-B	Comfort sweatband, 12/case	06-0400-52	Pivot mechanism 9100 headband, left and right.
06-0200-10	Inside protection plate 9100V, 5/case	06-0201-10	9100V Starter Kit, incl 5 outside protection plates, 2 inside protection plates and 1 sweatband	06-0400-53	Headband 9100 front part.
06-0200-10-B	Inside protection plate 9100V, 25/case	06-0201-20	9100X Starter Kit, incl 5 outside protection plates, 2 inside protection plates and 1 sweatband	06-0400-54	Headband 9100 back part.
06-0200-20	Inside protection plate 9100X, 5/case	06-0201-30	9100XX Starter Kit, incl 5 outside protection plates, 2 inside protection plates and 1 sweatband	06-0400-55	Battery holder 9100, 2/case
06-0200-20-B	Inside protection plate 9100X, 25/case	06-0300-51	9100 Helmet without SideWindows, with headband and silver front panel	06-0500-51	Extended coverage 9100, 1 Crown
06-0200-30	Inside protection plate 9100XX, 5/case	06-0300-51SW	9100 Helmet with SideWindows, with headband and silver front panel	06-0500-52	Extended coverage 9100, Ear & Neck
06-0200-30-B	Inside protection plate 9100XX, 25/case	06-0300-52	9100 Helmet without SideWindows, headband and silver front panel	06-0500-53*	SideWindows cover plate, 2/eaches.
06-0200-51	Outside protection plate standard, 10/case			06-0500-56	Magnifying lens 1.5.
06-0200-51-B	Outside protection plate standard, 50/case			06-0500-57	Magnifying lens 2.0.
06-0200-52	Outside protection plate scratch resistant, 10/case			06-0500-58	Magnifying lens 2.5.
06-0200-52-B	Outside protection plate scratch resistant, 50/case			06-0500-59	Magnifying lens 3.0.
				06-0700-83	Full Hood, black/grey.

\* Please use Part No 06-0300-52SW when ordering replacement SideWindows.

# 3M™ Speedglas™ Welding Helmet 9100 FX



Part No	Description	Part No	Description	Part No	Description
06-0600-10SW	Speedglas Helmet 9100FX with 9100V ADF and SideWindows.	06-0600-20SW	Speedglas Helmet 9100FX with 9100X ADF and SideWindows	06-0600-30SW	Speedglas Helmet 9100FX with 9100XX ADF and SideWindows.

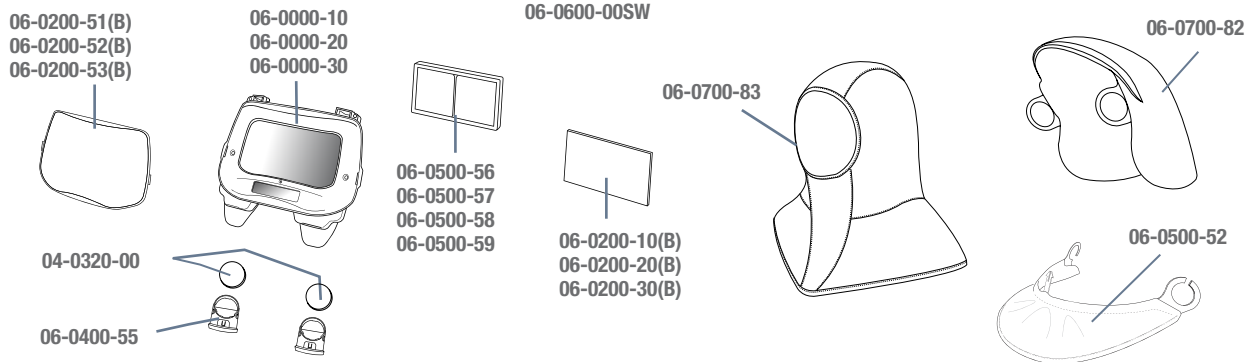
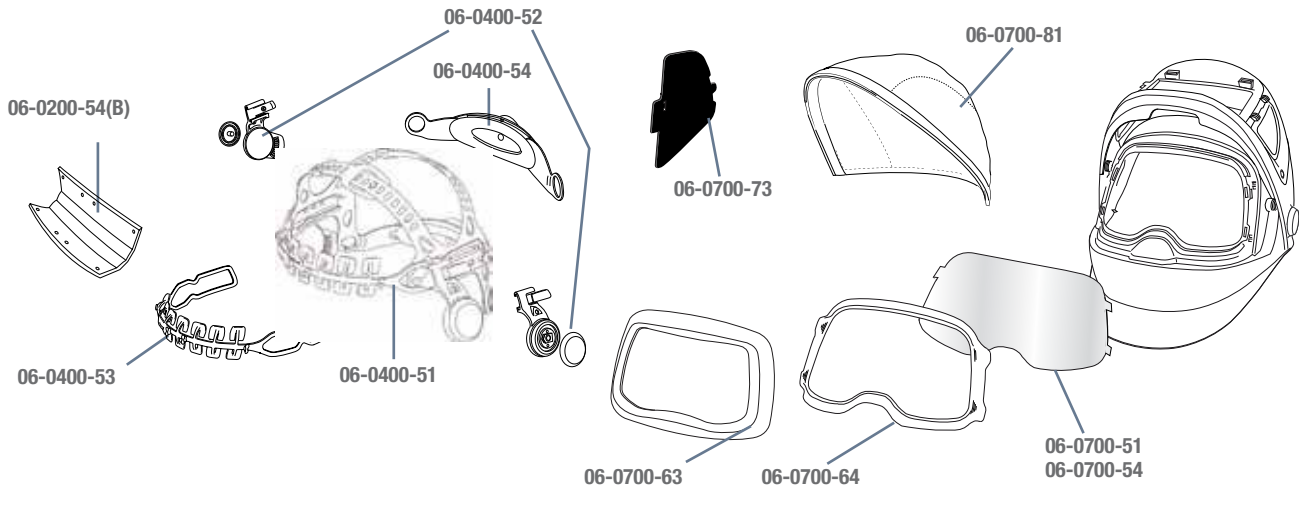

## Accessories and consumables

Part No	Description	Part No	Description	Part No	Description
04-0320-00	Battery, 2/case.	06-0200-51B	standard, 10/case	06-0500-57	Magnifying lens 2.0.
06-0000-10	Speedglas 9100V Welding ADF, variable shade 5, 8, 9-13.	06-0200-52	Outside protection plate standard, 50/case	06-0500-58	Magnifying lens 2.5.
06-0000-20	Speedglas 9100X Welding ADF, variable shade 5, 8, 9-13.	06-0200-52B	Outside protection plate scratch resistant, 10/case	06-0500-59	Magnifying lens 3.0.
06-0000-30	Speedglas 9100XX Welding ADF, variable shade 5, 8, 9-13.	06-0200-52B	Outside protection plate scratch resistant, 50/case	06-0600-00SW	Speedglas 9100 FX helmet, without ADF, with headband.
06-0200-10	Inside protection plate for 9100V ADF, 5/case	06-0200-53	Outside protection plate high temperature, 10/case	06-0700-51	Wide-view clear grinding visor, 5/case
06-0200-10-B	Inside protection plate for 9100V ADF, 25/case	06-0200-53B	Outside protection plate high temperature, 50/case	06-0700-54	Wide-view clear grinding visor, anti-fog, 5/case.
06-0200-20	Inside protection plate for 9100X ADF 5/case	06-0200-54	Comfort sweatband, 3/case	06-0700-63	Front Panel, Chrome
06-0200-20-B	Inside protection plate for 9100X ADF 25/case	06-0200-54B	Comfort sweatband, 12/case	06-0700-64	Wide-view clear grinding visor frame, Black
06-0200-30	Inside protection plate for 9100XX ADF, 5/case	06-0400-51	9100 headband including assembled parts	06-0700-73	SideWindows cover plate, 2 pairs.
06-0200-30-B	Inside protection plate for 9100XX ADF, 25/case	06-0400-53	Headband front part.	06-0700-81	Extended coverage 9100FX, Standard
06-0200-51	Outside protection plate	06-0400-54	Headband back part.	06-0700-82	Extended coverage 9100FX, X-Large
		06-0400-55	Battery holder, 2/case.	06-0700-83	Full hood, black and grey
		06-0500-52	Extended coverage, Ear & Neck		
		06-0500-56	Magnifying lens 1.5.		

# Featured Accessories

Every welder is different, and each day your tasks can change. As the owner of a 3M™ Speedglas™ Welding Helmet, you have a variety of accessories available to help increase your protection and comfort.

Plus, we now offer a new generation of additional coverage products made in flame-retardant textiles for protection against molten metal, sparks and flames:



06-0700-83



06-0500-52

06-0700-81  
06-0700-82

06-0500-51

06-0500-52

06-0500-54

06-0500-55

Ordering Information for Additional Coverage Products	3M™ Speedglas™ Welding Helmets 9000 Series	3M™ Speedglas™ Welding Helmets SL / 100	3M™ Speedglas™ Welding Helmets 9100 / 9100 Air	3M™ Speedglas™ Welding Helmets 9100 FX / 9100 FX Air
<b>Head protection</b>	Part No 16-0099-30	Part No. 16-0099-30	Part No 06-0500-51	Part No 06-0700-82 (large) Part No 06-0700-81 (small)
<b>Color</b>			Black EN ISO 11611	Black
<b>Neck protection</b>	Part No 02-0690-00 Black/Grey		Part No 06-0500-52 Black	
<b>Color</b>			Part No 06-0700-83* Black/grey	
<b>Welding beanie</b>			Part No 06-0500-54 Black Cotton	
<b>Color</b>				
<b>Material</b>				
<b>Welding cap</b>			Part No 06-0500-55 Black 50 Wash FR Fabric	
<b>Color</b>				
<b>Material</b>				

# 3M™ Speedglas™ Welding Helmet 100 Series



07-0012-31BY

Part No	Description	Part No	Description	Part No	Description
07-0012-31AH	Speedglas Welding Helmet 100 Aces High with 100V ADF.	07-0012-31BZ	Speedglas Welding Helmet 100 Blaze, with 100V ADF.	07-0012-31SR	Speedglas Welding Helmet 100 Steel Rose with 100V ADF.
07-0012-31AP	Speedglas Welding Helmet 100 American Pride with 100V ADF.	07-0012-31IH	Speedglas Welding Helmet 100 Ice Hot with 100V ADF.	07-0012-31TW	Speedglas Welding Helmet 100 Trojan Warrior with 100V ADF.
07-0012-10BL	Speedglas Welding Helmet 100 Black with 100S-10 ADF.	07-0012-31RD	Speedglas Welding Helmet 100 Razor Dragon with 100V ADF.	07-0012-31WP	Speedglas Welding Helmet 100 Wild 'n' Pink with 100V ADF.
07-0012-11BL	Speedglas Welding Helmet 100 Black with 100S-11 ADF.	07-0012-31RS	Speedglas Welding Helmet 100 Raging Skull with 100V ADF.	07-0012-31XT	Speedglas Welding Helmet 100 Xterminator with 100V ADF.
07-0012-31BL	Speedglas Welding Helmet 100 Black with 100V ADF.	07-0012-31SE	Speedglas Welding Helmet 100 Steel Eyes with 100V ADF.		
07-0012-31BY	Speedglas Welding Helmet 100 Boneyard with 100V ADF.	07-0012-31SJ	Speedglas Welding Helmet 100 Skull Jewels with 100V ADF.		

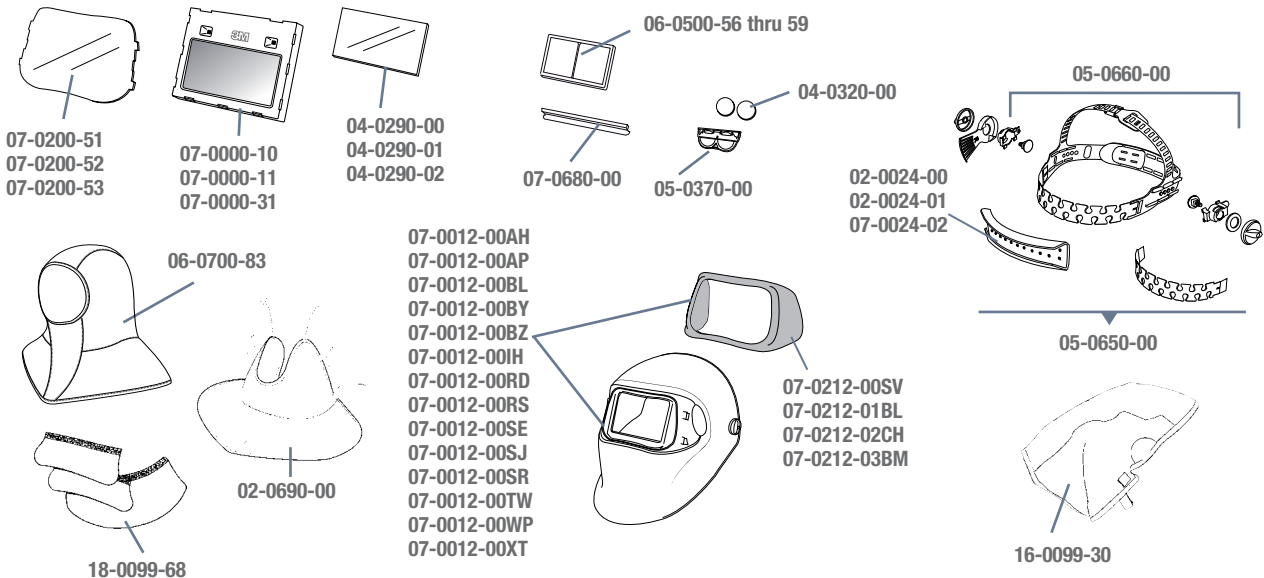

## Accessories and consumables

Part No	Description	Part No	Description	Part No	Description
02-0024-00	Sweatband, fleecy cotton	07-0012-00AH	Welding helmet Aces High, without welding filter, headband.	07-0012-00TW	Welding helmet Trojan Warrior, without welding filter, headband.
02-0024-01	Sweatband, leather.	07-0012-00AP	Welding helmet American Pride, without welding filter, headband.	07-0012-00WP	Welding helmet Wild n' Pink, without welding filter, headband.
02-0690-00	Neck protection	07-0012-00BL	Welding helmet black, without welding filter, headband.	07-0012-00XT	Welding helmet Xterminator, without welding filter, headband.
04-0290-00	Inner cover plate, 5/case. Plate marking 42 02 00.	07-0012-00BY	Welding helmet Boneyard, without welding filter, headband.	07-0024-02	Sweatband, towelling, 2/case.
04-0290-01	Inner cover plate, +1 shade, 5/case.	07-0012-00BZ	Welding helmet Blaze, without welding filter, headband.	07-0200-51	Outer protection plate, standard, 10/case
04-0290-02	Inner cover plate, +2 shade, 5/case.	07-0012-00IH	Welding helmet Ice Hot, without welding filter, headband.	07-0200-52	Outer protection plate, scratch resistant, 10/case.
04-0320-00	Battery, 2/case.	07-0012-00RD	Welding helmet Razor Dragon without welding filter, headband.	07-0200-53	Outer protection plate, heat resistant, 10/case.
05-0370-00	Battery cover.	07-0012-00RS	Welding helmet Raging Skull without welding filter, headband.	07-0212-00SV	Silver front frame 100
05-0650-00	Comfort Headband with assembly parts.	07-0012-00SE	Welding helmet Steel Eyes, without welding filter, headband.	07-0212-01BL	Black front frame 100, glossy
05-0660-00	Assembly parts for headband.	07-0012-00SJ	Welding helmet Skull Jewels, without welding filter, headband.	07-0212-02CH	Chrome front frame 100
06-0500-56	Magnifying lens 1.5.	07-0012-00SR	Welding helmet Steel Rose, without welding filter, headband.	07-0212-03BM	Black front frame 100, matte
06-0500-57	Magnifying lens 2.0.			07-0680-00	Holder for magnifier.
06-0500-58	Magnifying lens 2.5.			16-0099-30	Headcover, FR Cotton
06-0500-59	Magnifying lens 3.0.			18-0099-68	Ear and neck protection in leather.
06-0700-83	Hood black/grey				
07-0000-10	Speedglas 100S-10 Welding Filter, single shade 10.				
07-0000-11	Speedglas 100S-11 Welding Filter, single shade 11.				
07-0000-31	Speedglas 100V Welding Filter, variable shade 8-12.				

# 3M™ Speedglas™ Welding Helmet SL



05-0013-41

Part No	Description	Part No	Description	Part No	Description
02-0024-00	Sweatband, fleecy cotton.	05-0013-41	Speedglas Helmet SL with welding filter, variable shade 8–12.	05-0695-00	Spatter protector
02-0024-01	Sweatband, leather.	05-0250-00	Outer protection plate, standard, 5/case.	06-0500-56	Magnifying lens 1.5.
02-0690-00	Neck protection	05-0250-01	Outer protection plate, scratch resistant, 5/case.	06-0500-57	Magnifying lens 2.0.
04-0290-00	Inner cover plate, 5/case.	05-0370-00	Battery cover.	06-0500-58	Magnifying lens 2.5.
04-0320-00	Battery, 2/case.	05-0650-00	Headband with assembly parts.	06-0500-59	Magnifying lens 3.0.
05-0000-41	Speedglas Welding Filter SL, variable shade 8-12.	05-0660-00	Assembly parts for headband.	06-0700-83	Hood black/grey.
05-0013-00	Welding helmet, without headband or welding filter.	05-0680-00	Magnifying lens holder	07-0024-02	Sweatband, towelling, black 2/case.
				16-0099-30	Headcover, FR Cotton
				18-0099-68	Ear and neck protection in leather (3 parts).

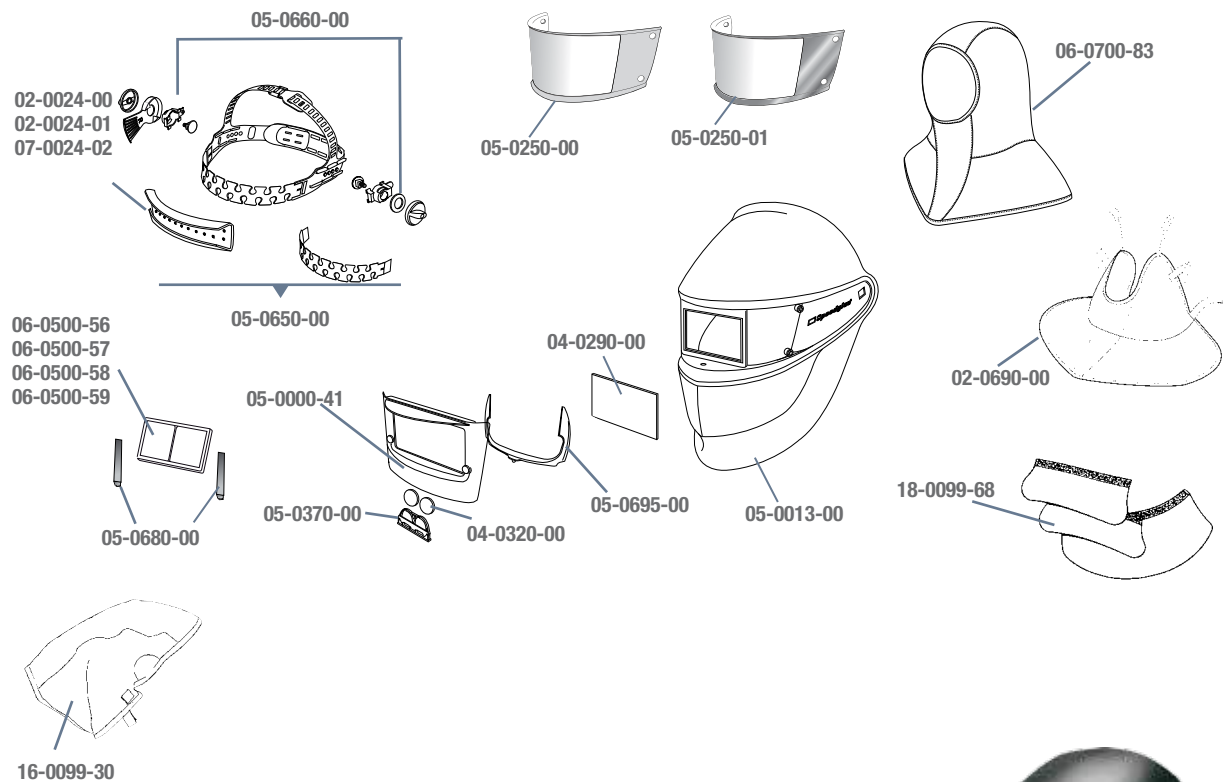

# 3M™ Speedglas™ Helmets 9000 / FlexView with 9002D ADF



04-0012-15  
04-0012-15SW

Part No	Description	Part No	Description
04-0012-15	9000 Welding Helmet, without SideWindows, with 9002D Filter, dual shade 10/11.	04-0016-15	9000 FlexView Welding Helmet, without SideWindows, with 9002D Filter, dual shade 10/11.
04-0012-15SW	9000 Welding Helmet with SideWindows and 9002D Filter, dual shade 10/11.	04-0016-15SW	9000 FlexView Welding Helmet with SideWindows, and 9002D Filter, dual shade 10/11.

# 3M™ Speedglas™ Welding Helmets Series 9000 / FlexView / Utility

## Accessories and consumables

Part No	Description	Part No	Description	Part No	Description
02-0014-00NR	Hard Hat Adapter (not shown)	04-0067-00	Assembly parts for headband.		9002X/9000XF Filters, 5/case.
02-0023-00	Hard Hat with mounting hardware (not shown)	04-0112-00	9000 Helmet inner shell without SideWindows	04-0290-00	Inner cover plate for 9002D/9002V Filters, 5/case.
02-0024-00	Sweatband, fleecy cotton, 2/case.	04-0112-00SW	9000 Helmet inner shell with SideWindows	04-0290-01	Inner cover plate, +1 Shade for 9002D/9002V Filters, 5/case.
02-0024-01	Sweatband, leather.	04-0114-00	Utility Helmet inner shell	04-0290-02	Inner cover plate, +2 Shade for 9002D/9002V Filters, 5/case.
02-0690-00	Neck protection	04-0126-00	FlexView Pivot "S" Stop (left)	04-0320-00	Battery, 2/case.
04-0000-15	Speedglas Welding Filter 9002D.	04-0212-00	9000 silver front panel	04-0360-00	Holder for welding filter, includes hinge spring.
04-0000-31	Speedglas Welding Filter 9002V.	04-0216-00	FlexView silver front panel	04-0361-00	FlexView Middle helmet, black.
04-0000-21	Speedglas Welding Filter 9002X.	04-0260-00	FlexView protection plate, 10/case.	04-0380-00	Battery holder blue, 2/case.
04-0012-00	9000 Helmet, without SideWindows, without filter, with headband.	04-0270-01	Outer protection plate, standard, 10/case.	04-0390-00	Battery holder black, 2/case.
04-0012-00SW	9000 Helmet, with SideWindows, with headband, without filter.	04-0270-03	Outer protection plate, scratch resistant, 5/case.	04-0460-00	FlexView Conversion Kit.
04-0016-00	FlexView Helmet without SideWindows, without welding filter.	04-0270-04	Outer protection plate, heat resistant, 5/case.	04-0550-00	FlexView Locking wedge kit (holder welding filter).
04-0016-00SW	FlexView Helmet with SideWindows, without welding filter.	04-0280-00	Inner cover plate for 9002X/9000XF Filters, 5/case.	04-0650-00	Headband with assembly parts.
04-0022-00	9000 Helmet, without SideWindows, without headband, without filter.	04-0280-01	Inner cover plate, +1 Shade for 9002X/9000XF Filters, 5/case.	06-0700-83	Hood black/grey.
04-0022-00SW*	9000 Helmet with SideWindows, without headband, without filter.	04-0280-02	Inner cover plate, +2 Shade for 9002X/9000XF Filters, 5/case.	07-0024-02	Sweatband towelling, 2/case.
04-0026-00	Headband Pivot "S" Stop (right)			16-0099-30	Headcover, FR Cotton
				18-0099-68	Ear and neck protection in leather.

\* Please use Part No 04-0022-00SW when new SideWindows are required.

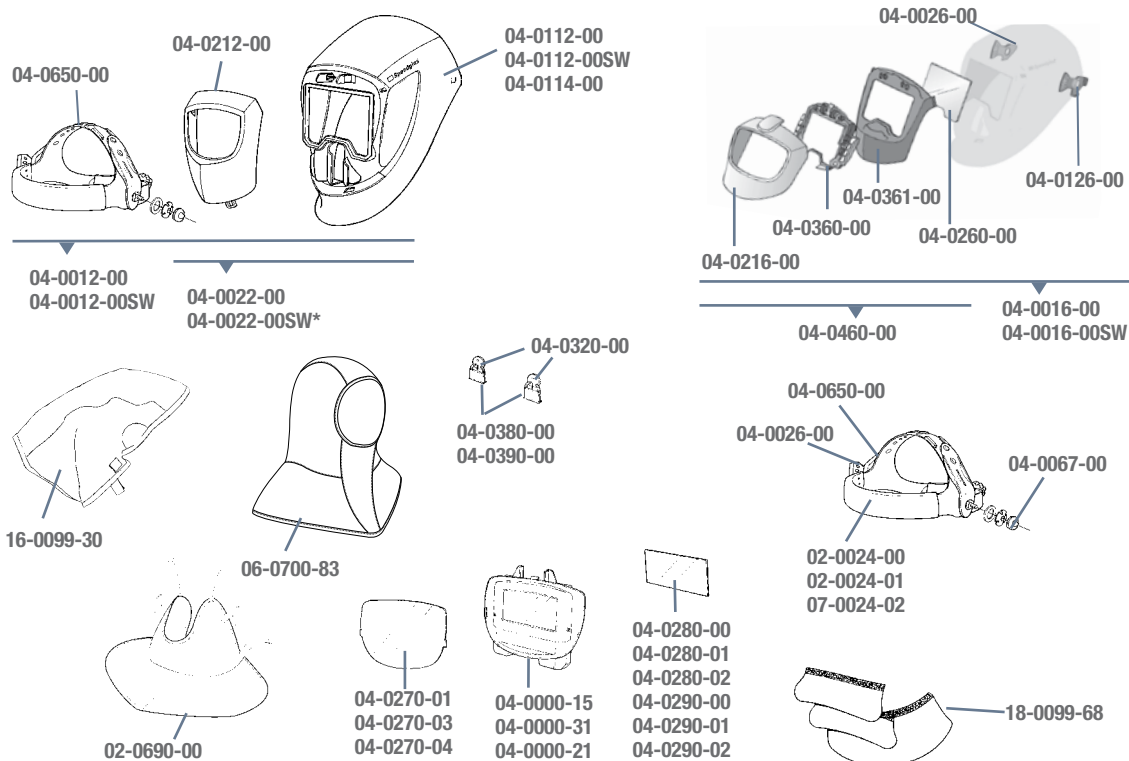



# 3M™ Speedglas™ Welding Helmet 9000 Series ProTop with Hard hat



04-0015-15SW  
04-0015-31SW  
04-0015-21SW

Part No	Description	Part No	Description	Part No	Description
04-0015-15	ProTop System without SideWindows, with 9002D Filter.	04-0015-31	ProTop Welding Helmet without SideWindows, with 9002V Filter.	04-0015-21SW	ProTop Welding Helmet with SideWindows and 9002X Filter.
04-0015-21	ProTop Welding Helmet without SideWindows, with 9002X Filter.	04-0015-15SW	ProTop Welding Helmet with SideWindows and 9002D Filter.	04-0015-31SW	ProTop Welding Helmet with SideWindows and 9002V Filter.

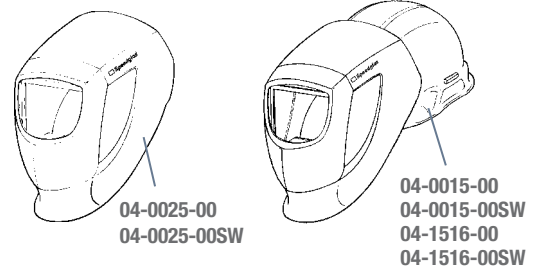
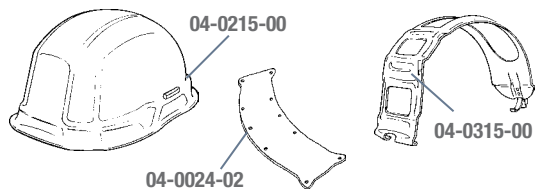

## Accessories and consumables

Part No	Description	Part No	Description	Part No	Description
04-0015-00	ProTop system without welding filter.	04-0025-00SW	ProTop System with SideWindows, without hard hat, welding filter and strap	04-1516-00	FlexView ProTop Welding Helmet without welding filter.
04-0015-00SW	ProTop System with SideWindows, without welding filter.	04-0215-00	Hard hat, white	04-1516-00SW	FlexView ProTop with SideWindows, without welding filter
04-0024-02	Sweatband, 2/case.	04-0315-00	Hard hat assembly parts.		
04-0025-00	ProTop System without hard hat welding filter and strap				

# Hard hat Options for 3M™ Speedglas™ Welding Helmets 9100 / 100



Part No	Description	Part No	Description	Part No	Description
06-0014-00NR	Speedyloop for Speedglas 9100 welding helmet with hard hat assembly parts.	06-0100-20HASW	Speedglas 9100 Welding Helmet with 9100X welding filter and hard hat adapter.	06-0100-30HHSW	Speedglas 9100 Welding Helmet with 3M H-701R Hard hat, with 9100XX Welding Filter.
06-0100-10HASW	Speedglas 9100 Welding Helmet with 9100V welding filter and hard hat adapter	06-0100-20HHSW	Speedglas 9100 Welding Helmet with 3M H-701R Hard hat, with 9100X Welding Filter.	07-0012-31BL-HH	Speedglas 100 Welding Helmet with 3M H-701R Hard hat, with 100V Welding Filter.
06-0100-10HHSW	Speedglas 9100 Welding Helmet with 3M H-701R Hard hat, with 9100V Welding Filter.	06-0100-30HASW	Speedglas 9100 Welding Helmet with 9100XX welding filter and hard hat adapter	07-0014-00NR	Speedyloop for Speedglas 100 welding helmet with hard hat assembly parts.

\*Image shown is a vented model. Assemblies come with a non-vented hard hat.

# Compatibility of Air Delivery Units and Headtops

The new Speedglas Welding Helmets 9100 Series feature the QRS Breathing Tube (Quick Release Swivel), which enables one-handed connection and release. The SG-30W breathing tube comes standard with complete Adflo™

PAPR HE and Fresh-air III supplied air systems. The SG-50W is standard on the Adflo™ PAPR HE/OV-AG systems and the SG-40W breathing tube is an option for more demanding conditions

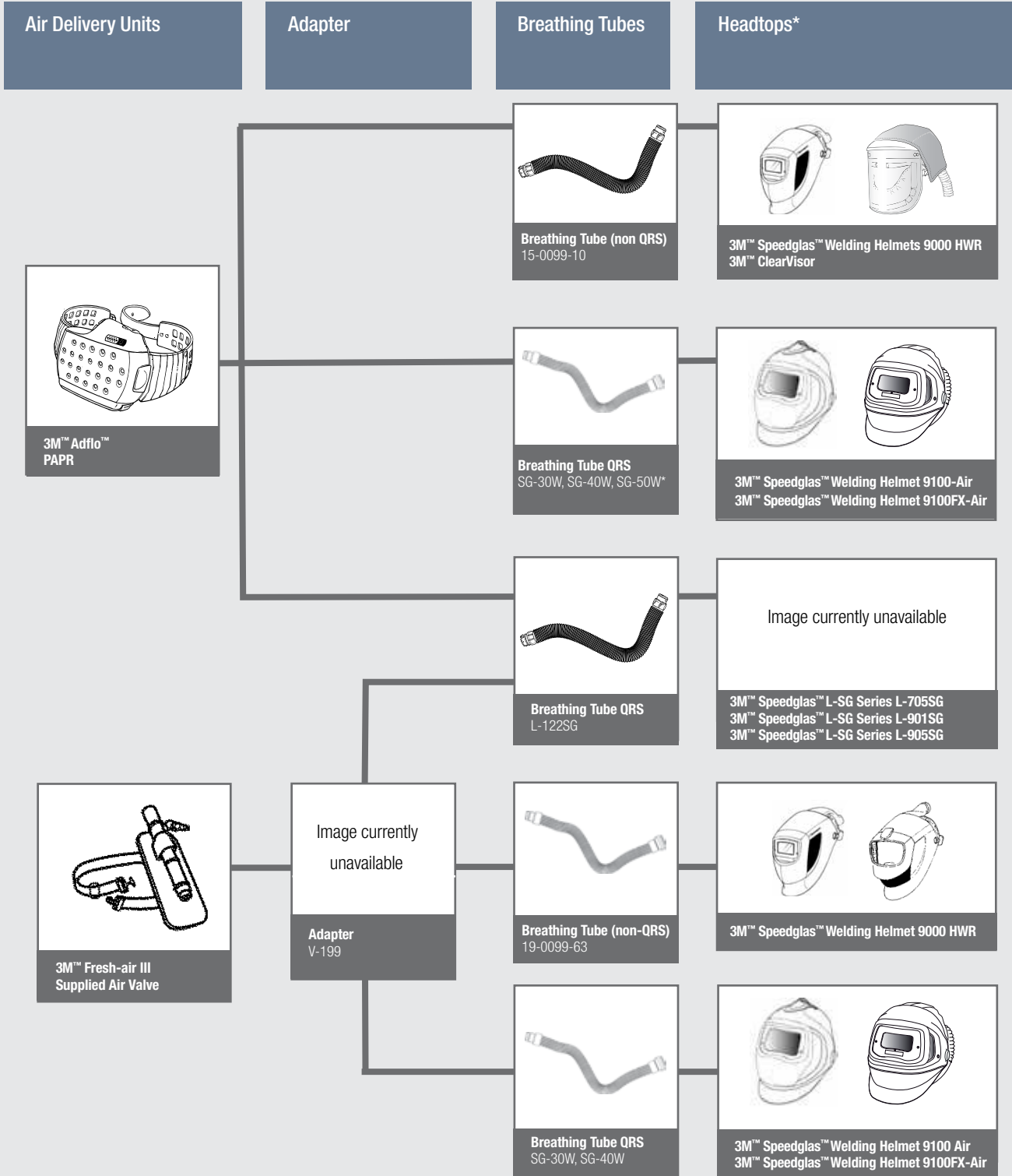

\*The SG-50W breathing tube is required when used with 3M™ Adflo™ PAPR with HE filter and OV/AG Cartridge and 3M™ Speedglas™ Welding Helmet 9100-Air. It is not NIOSH-approved with V-Series Supplied Air valves.

# 3M™ Adflo™ Powered Air Purifying Respirator

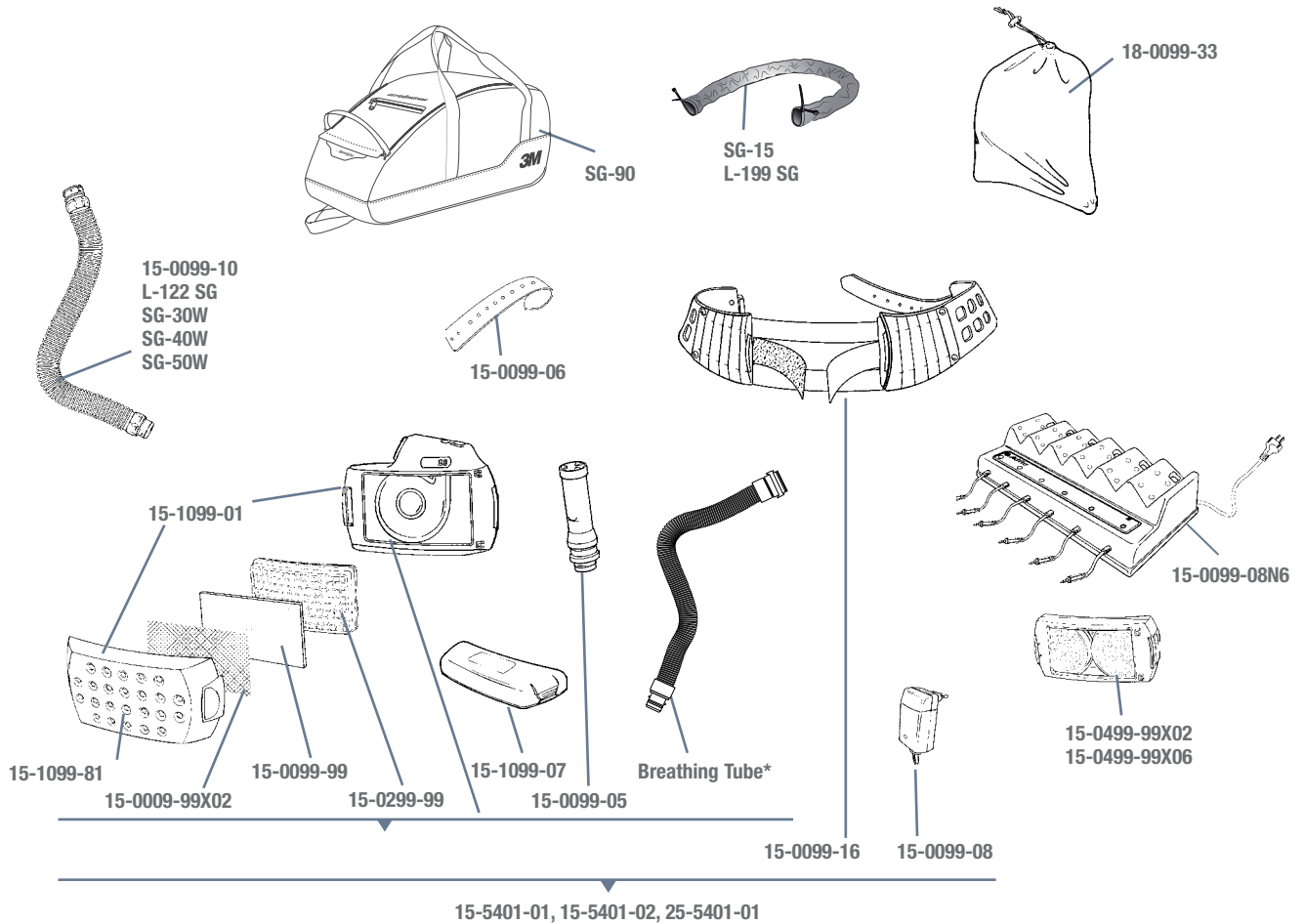

Part No	Description	Part No	Description	Part No	Description
15-0099-99X02	Spark arrestor. 2/case	15-0499-99X06	OV/AG Cartridge 6/case.		charger.
15-0099-05	Airflow indicator	15-1099-01	PAPR assembly and cover	L-122SG	Breathing tube for L-Series helmets
15-0099-06	Belt tongue extender	15-1099-07	Battery	L-199 SG	High temperature breathing tube cover
15-0099-08	Battery charger.	15-1099-81	PAPR filter cover	SG-15	Flame resistant breathing tube cover. Replaces 17-0099-54.
15-0099-10	Breathing tube, includes 15-0099-11 and 15-0099-12	*15-5401-01	Adflo PAPR with breathing tube (15-0099-10), breathing tube, adapter, airflow indicator, prefilter, spark arrestor, particle filter, battery, belt and charger.	SG-30W	Breathing tube, self-adjusting (52.5 to 85 cm), with QRS connection.
15-0099-11	Gasket for non-QRS breathing tubes, not shown, 5/case.	*15-5401-02	Adflo PAPR with L-122SG breathing tube, airflow indicator, prefilter,spark arrestor, particle filter, battery, belt and charger.	SG-40W	Breathing tube, heavy-duty rubber, with QRS connection.
15-0099-12	Breathing tube rubber O-Ring (not shown)	18-0099-33	Storage bag.	SG-50W	Breathing tube with silencer with QRS connection.
15-0099-16	Belt.	*25-5401-01	Adflo PAPR with SG-30W self-adjusting breathing tube, airflow indicator, prefilter,spark arrestor, particle filter,battery, belt and	SG-90	Product carry bag.
15-0099-08N6	6-station battery charger.				
15-0099-99X06	Prefilter, 6/case.				
15-0099-99X12	Prefilter, 12/case.				
15-0299-99X02	HE particle filter 2/Case				
15-0299-99X06	HE particle filter 6/case				
15-0299-99X36	HE particle filter 36/case				
15-0499-99X02	OV/AG Cartridge 2/case.				

# 3M™ Fresh-air III Supplied Air System



Part No	Description	Part No	Description	Part No	Description
19-0099-63	Fresh-air III Breathing tube V-Series	V-111	Vortex Muffler Kit (replacement muffer for the V-100 and V-100SS Vortex cooling assemblies)	V-211	Vortemp Muffler Kit (replacement muffer for the V-200 and V-200SS Vortemp heating assemblies)
SG-30W	Breathing tube, self-adjusting (52,5 to 85 cm), with QRS connection.	V-115	Vortex Spare Parts Kit (for the V-100 and V-100SS Vortex cooling assemblies)	V-215	Vortemp Spare Parts Kit (for the V-200 and V-200SS Vortemp heating assemblies)
SG-40W	Breathing tube, heavy-duty rubber, with QRS connection.	V-150	Vortex Cooling Tube	V-250	Vortemp Heating Tube
V-100	Vortex Cooling Assembly, includes tube V-150, belt W-2963 and holder	V-200	Vortemp Heating Assembly, includes tube V-250, belt W-2963 and holder	W-2963	Belt

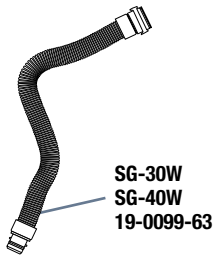
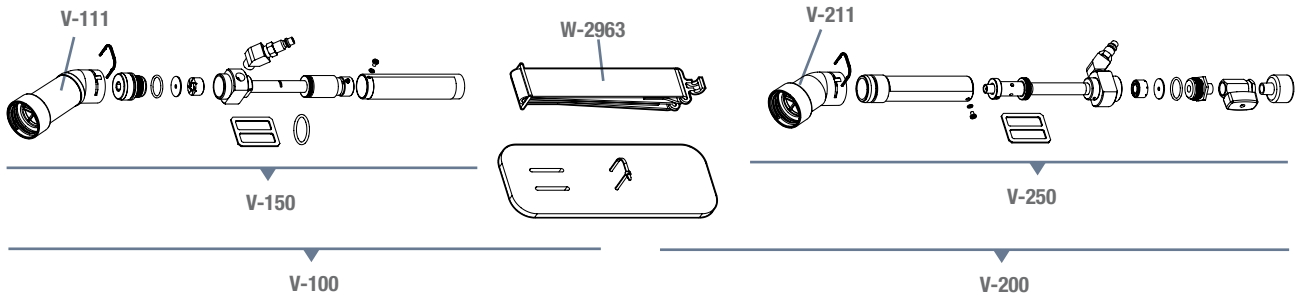

# 3M™ Fresh-air II Supplied Air System



Part No	Description	Part No	Description	Part No	Description
18-0099-16	Comfort Belt	18-0099-41	Breather Hose with Couplings, 50 ft. (15.24 m)	18-0099-44	NyCoil™ Hose with Couplings, 50 ft. (15.24 m)
18-0099-33	Carry Bag	18-0099-42	Breather Hose with Couplings, 100 ft. (30.48 m)	18-0099-45	NyCoil™ Hose with Couplings, 100 ft. (30.48 m)
18-0099-55	Fresh-air II Valve Shield	18-0099-43	NyCoil™ Hose with Couplings, 25 ft. (7.62 m)		
18-0099-63	Fresh-air Supplied Air Breathing Tube V-Series				
18-0099-40	Breather Hose with Couplings, 25 ft. (7.62 m)				

# 3M™ Compressed Air Filter and Regulator Panels for 3M™ Speedglas™ Supplied Air Systems

Part No	Description
256-02-00	Portable Compressed Air Filter and Regulator Panel, 50 cfm, 4 outlets, with carbon monoxide filtration and monitor (not shown)
256-02-01	Portable Compressed Air and Regulator Panel, 100 cfm, 8 outlets, with carbon monoxide monitor (not shown)
W-2806	Compressed Air Filter and Regulator Panel
W-2808	CO Monitor with Retrofit kit

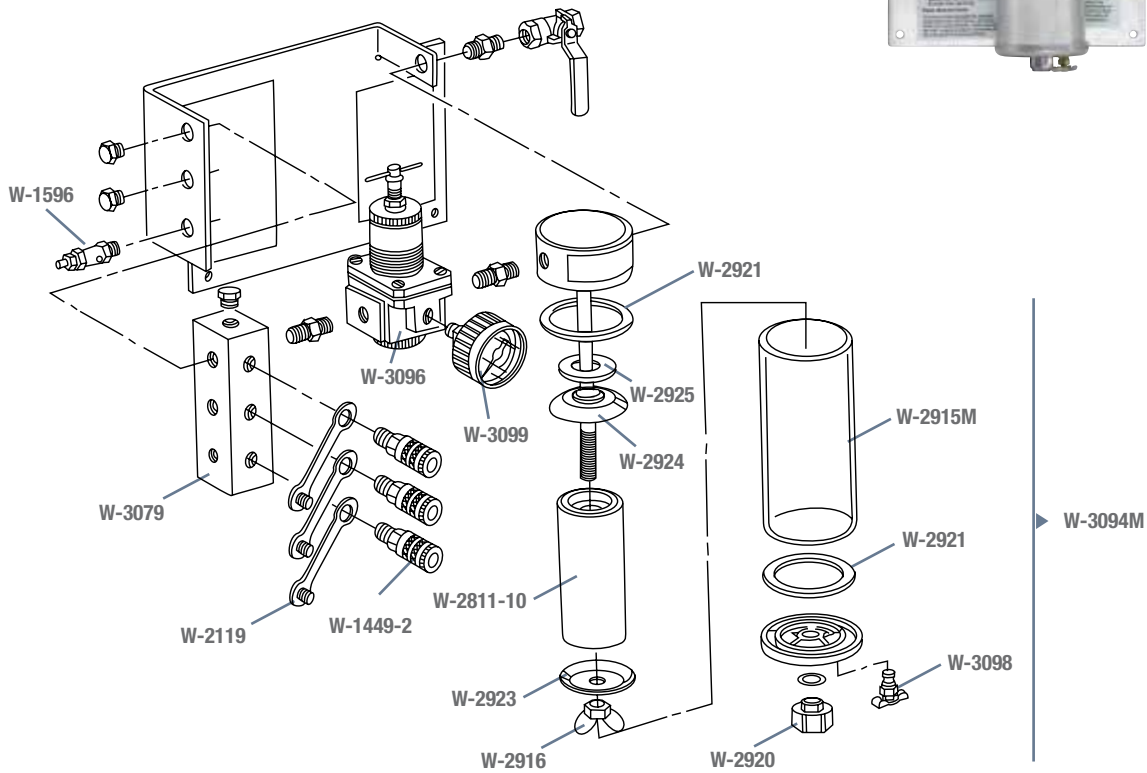
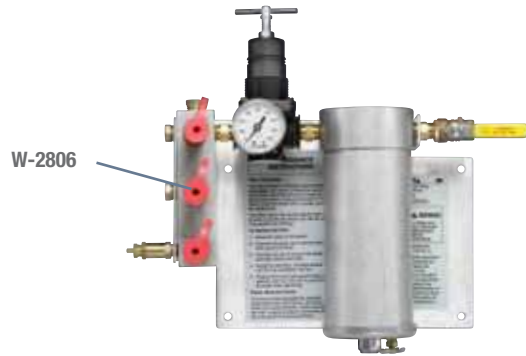

## Accessories and replacement parts for W-2806

Part No	Description	Part No	Description	Part No	Description
529-04-50	Adapter, 110-120 Volt (not shown)	W-2119	Socket Dust Cap	W-3013-4	High efficiency filter element 4.case (for W-3012, not shown)
529-04-48	Calibration Kit, Large (not shown)	W-2808	Retrofit carbon monoxide monitor kit (optional, not shown)	W-3079	Manifold
529-04-49	Calibration Kit, Small (not shown)	W-2811-10	Filter Cartridge, 10/case	W-3094M	Filter Housing Assembly
529-05-20	Remote Alarm Audible, 119 dBA (not shown)	W-2915M	Aluminium Filter Bowl (part of W-3094M)	W-3095	Filter Housing Base (part of W-3094M)
529-05-21	Remote Alarm, Strobe Light, 150,000 CP (requires 529-04-50, not shown)	W-2916	Wing Nut	W-3096	Air Pressure Regulator
529-05-23	Y-Plug Adapter (not shown)	W-2920	Nut Base	W-3098	Drain Valve
W-1449-2	Socket, 3/8 in MPT, 1/4 in Body Size, Industrial interchange, 2/case	W-2921	Bowl Gasket	W-3099	Air Pressure Gauge
W-1596	Pressure Relief Valve	W-2923	Cartridge Washer	W-3281-2	Socket, Hansen S23 (3/8 in Male NPT), 2/case (Not Shown)
		W-2924	Air Deflector	W-3182-2	Socket, 3/8 in MPT, 1/4 in Body Size, Schrader, 2/case (Not Shown)
		W-2925	Air Deflector Gasket		
		W-3012	Coalescing Filter Assembly (optional, not shown)		

# 3M™ Speedglas™ Welding Helmet 9100-Air for Respiratory Protection



Part No	Description	Part No	Description	Part No	Description
25-1101-00SW	Speedglas 9100-Air Welding Helmet and Adflo PAPR with HE filter (no ADF)	25-3301-10SW	Speedglas 9100-Air Welding Helmet with 9100V ADF and Adflo PAPR with HE and OV/AG filter	25-5702-30SW	Speedglas 9100-Air Welding Helmet with 9100XX ADF and Fresh-air III, V-200 SAR
25-1101-10SW	Speedglas 9100-Air Welding Helmet with 9100V ADF and Adflo PAPR with HE filter	25-3301-20SW	Speedglas 9100-Air Welding Helmet with 9100X ADF and Adflo PAPR with HE and OV/AG filter	25-5802-10SW	Speedglas 9100-Air Welding Helmet with 9100V ADF and Fresh-air III, V-200 SAR
25-1101-20SW	Speedglas 9100-Air Welding Helmet with 9100X ADF and Adflo PAPR with HE filter	25-3301-30SW	Speedglas 9100-Air Welding Helmet with 9100XX ADF and Adflo PAPR with HE and OV/AG filter	25-5802-20SW	Speedglas 9100-Air Welding Helmet with 9100X ADF and Fresh-air III, V-200 SAR
25-1101-30SW	Speedglas 9100-Air Welding Helmet with 9100V ADF and Adflo PAPR with HE filter ADF.	25-5702-10SW	Speedglas 9100-Air Welding Helmet with 9100V ADF and Fresh-air III, V-100 SAR	25-5802-30SW	Speedglas 9100-Air Welding Helmet with 9100XX ADF and Fresh-air III, V-200 SAR
25-3301-00SW	Speedglas 9100-Air Welding Helmet and Adflo PAPR with HE filter and OV/AG filter (no ADF)	25-5702-20SW	Speedglas 9100-Air Welding Helmet with 9100X ADF and Fresh-air III, V-100 SAR		

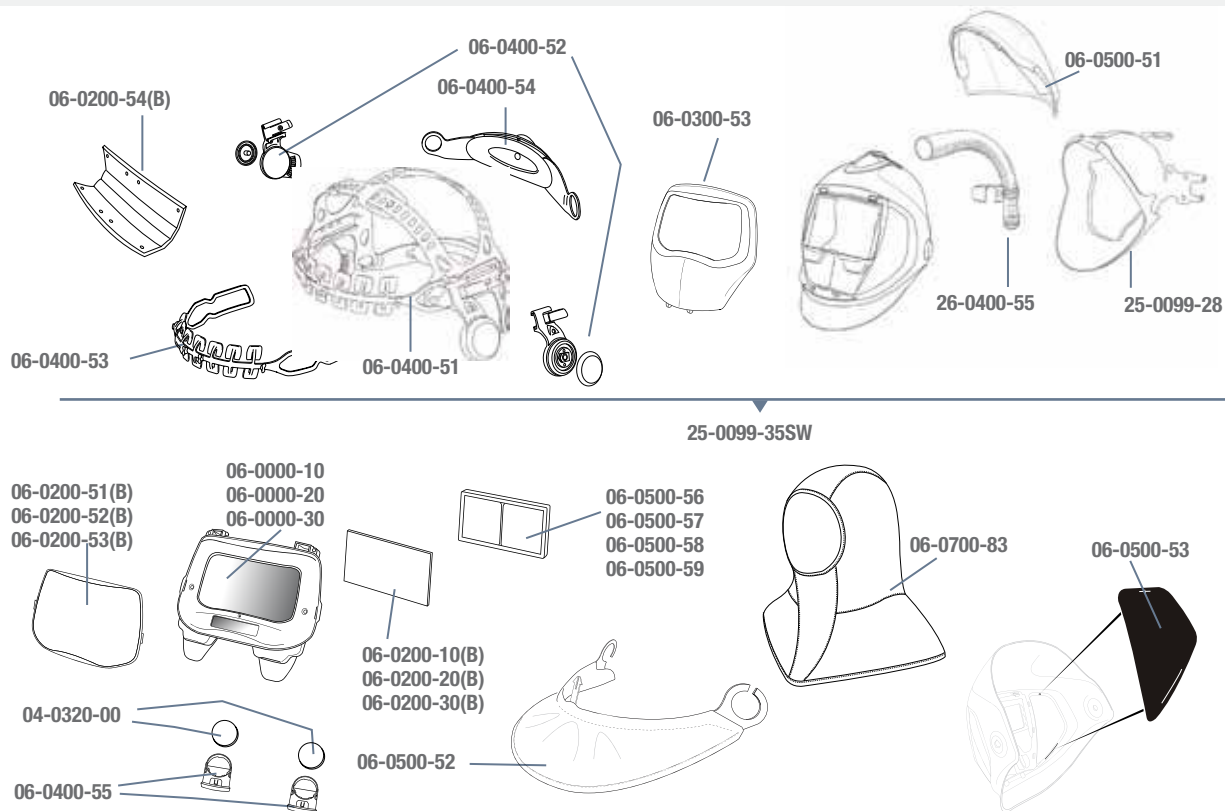

## Accessories and consumables

Part No	Description	Part No	Description	Part No	Description
04-0320-00	Battery, 2/case.	06-0200-52(B)	Outer protection plate, extra scratch resistant, 10/case.	06-0500-51	Head protection, black.
06-0000-10	Speedglas Welding Filter 9100V.	06-0200-53(B)	Outer protection plate, heat resistant 10/case.	06-0500-52	Neck protection, black.
06-0000-20	Speedglas Welding Filter 9100X.	06-0200-54(B)	Comfort sweatband, pkg of 3.	06-0500-53*	SideWindows cover plate, 2 pairs.
06-0000-30	Speedglas Welding Filter 9100XX.	06-0300-53	Heat-reflecting silver front.	06-0500-56	Magnifying lens 1.5.
06-0200-10(B)	Inner cover plate for 9100V Filter, 5/case.	06-0400-51	Speedglas 9100 Headband with assembly parts.	06-0500-57	Magnifying lens 2.0.
06-0200-20(B)	Inner cover plate for 9100X Filter, 5/case.	06-0400-52	Pivot mechanism, left and right.	06-0500-58	Magnifying lens 2.5.
06-0200-30(B)	Inner cover plate for 9100XX Filter, 5/case.	06-0400-53	Headband front part.	06-0500-59	Magnifying lens 3.0.
06-0200-51(B)	Outer protection plate, standard, 10/case.	06-0400-54	Headband back part.	06-0700-83	Hood, black/grey
		06-0400-55	Battery holder, 2/case.	26-0400-55	Air duct
				25-0099-28	Face seal
				25-0099-35SW	9100 Air Helmet, without welding filter.

\* Please use Part No 25-0099-35SW when new SideWindows are required.

# 3M™ Speedglas™ 9100 FX-Air Welding Helmet for Respiratory Protection



Part No	Description	Part No	Description	Part No	Description
26-1101-10SW	Speedglas 9100 FX-Air Welding Helmet with 9100V ADF and Adflo PAPP with HE filter	26-3301-10SW	Speedglas 9100 FX-Air Welding Helmet with 9100V ADF and Adflo PAPP with HE and OV/AG filter	26-5702-30SW	Speedglas 9100 FX-Air Welding Helmet with 9100XX ADF and Fresh-air III, V-200 SAR
26-1101-20SW	Speedglas 9100 FX-Air Welding Helmet with 9100X ADF and Adflo PAPP with HE filter	26-3301-20SW	Speedglas 9100 FX-Air Welding Helmet with 9100X ADF and Adflo PAPP with HE and OV/AG filter	26-5802-10SW	Speedglas 9100 FX-Air Welding Helmet with 9100V ADF and Fresh-air III, V-200 SAR
26-1101-30SW	Speedglas 9100 FX-Air Welding Helmet with 9100XX ADF and Adflo PAPP with HE filter ADF.	26-3301-30SW	Speedglas 9100 FX-Air Welding Helmet with 9100XX ADF and Adflo PAPP with HE and OV/AG filter	26-5802-20SW	Speedglas 9100 FX-Air Welding Helmet with 9100X ADF and Fresh-air III, V-200 SAR
26-3301-00SW	Speedglas 9100 FX-Air Welding Helmet and Adflo PAPP with HE filter and OV/AG filter (no ADF)	26-5702-10SW	Speedglas 9100 FX-Air Welding Helmet with 9100V ADF and Fresh-air III, V-100 SAR	26-5802-30SW	Speedglas 9100 FX-Air Welding Helmet with 9100XX ADF and Fresh-air III, V-200 SAR
		26-5702-20SW	Speedglas 9100 FX-Air Welding Helmet with 9100X ADF and Fresh-air III, V-100 SAR		

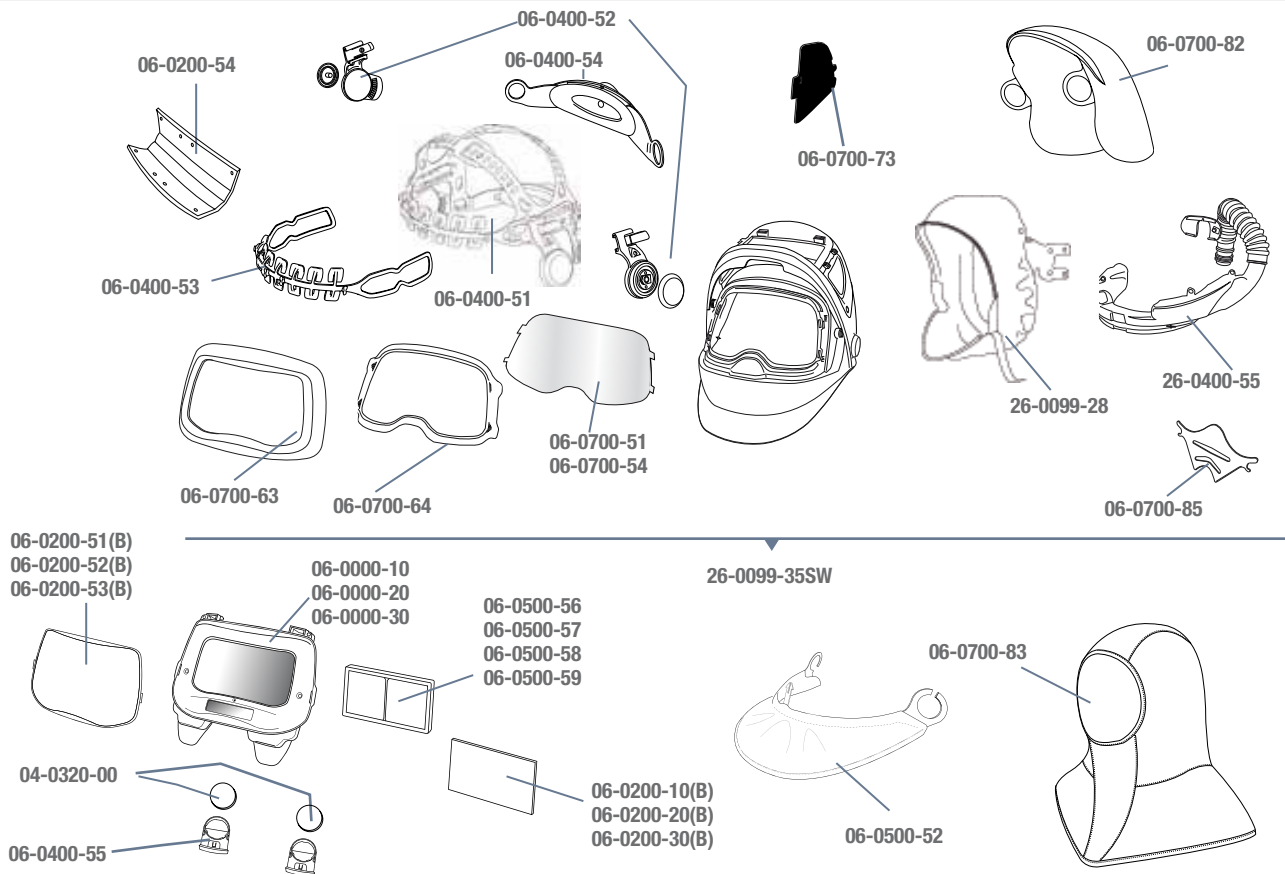

## Accessories and consumables

Part No	Description	Part No	Description	Part No	Description
04-0320-00	Battery, 2/case.	06-0200-53(B)	Outer protection plate, heat resistant, 10/case.	06-0700-54	Visor plate, anti-fog, 5/case.
06-0000-10	Speedglas 9100V Welding Filter.	06-0200-54(B)	Comfort sweatband, pkg of 3.	06-0700-63	Front plane, chrome
06-0000-20	Speedglas 9100X Welding Filter.	06-0400-51	9100 Series Headband, with assembly parts.	06-0700-64	Wide-view clear grinding visor frame, black
06-0000-30	Speedglas 9100XX Welding Filter.	06-0400-52	Pivot mechanism, left and right.	06-0700-73	SideWindow Covers
06-0200-10(B)	Inner cover plate for 9100V Filter, 5/case.	06-0400-53	Headband, front part.	06-0700-82	Headcover, large.
06-0200-20(B)	Inner cover plate for 9100X Filter, 5/case.	06-0400-54	Headband, back part.	06-0700-83	Hood, black/grey.
06-0200-30(B)	Inner cover plate for 9100XX Filter, 5/case.	06-0400-55	Battery holder, 2/case.	06-0700-85	Air diffuser
06-0200-51(B)	Outer protection plate, standard, 10/case.	06-0500-56	Magnifying lens 1.5.	26-0099-28	Face seal
06-0200-52(B)	Outer protection plate, extra scratch resistant, 10/case.	06-0500-57	Magnifying lens 2.0.	26-0099-35SW	Speedglas 9100 FX Air Welding Helmet without welding filter, with headband.
		06-0500-58	Magnifying lens 2.5.	26-0400-55	Air duct.
		06-0500-59	Magnifying lens 3.0.		
		06-0700-51	Visor plate, standard, 5/case.		

# 3M™ Speedglas™ Headgear Assembly 9000 HWR and 9000 FlexView HWR



## Accessories and consumables\*

Part No	Description	Part No	Description	Part No	Description
02-0024-01	Sweatband, leather.	04-0280-02	Inner cover plate, +2 Shade, for 9002X/9000XF Filters, 5/case.	14-0099-32SW*	Inner shell 9000HWR, with SideWindows, without airduct.
02-0690-00	Neck protection black/grey.	04-0290-00	Inner cover plate (42x91 mm) for 9002D/9002V Filters, 5/case.	14-0099-35	Headgear assembly 9000 HWR, without SideWindows, without ADF.
04-0000-15	Speedglas 9002D Welding Filter, dual shade 9/11.	04-0290-01	Inner cover plate (53x103 mm) for 9002X/9000XF Filters, 5/case.	14-0099-35SW	Headgear assembly 9000 HWR, with SideWindows, without ADF assembly 9000 HWR (not shown)
04-0000-21	Speedglas 9002X Welding Filter, variable shade 9–13.	04-0290-02	Inner cover plate, +2 Shade, for 9002D/9002V Filters, 5/case.	15-1699-29	9000 FlexView HWR Headband Assembly, with air duct
04-0000-31	Speedglas 9002V Welding Filter, variable shade 9–13.	04-0320-00	Battery, 2/case.	15-1699-32	9000 FlexView HWR Inner Shell
04-0026-00	Pivot "S" stop, Right	04-0360-00	Holder for welding filter	15-1699-32SW*	9000 FlexView HWR Inner Shell, with SideWindows
04-0067-00	Assembly parts for headband.	04-0361-00	FlexView Middle helmet, black.	15-1699-28	9000 FlexView HWR Face seal
04-0126-00	Pivot "S" stop, Left	04-0380-00	Battery holder blue, 2/case.	15-1699-35	Headgear assembly FlexView HWR, without SideWindows, without ADF
04-0212-00	Heat-reflecting, front silver panel.	04-0460-00	FlexView Conversion Kit	15-1699-35SW	Headgear assembly FlexView HWR, with SideWindows, without ADF
04-0216-00	FlexView silver front panel	06-0500-56	Magnifying lens 1.5.	16-0099-30	FR Head cover
04-0260-00	FlexView protection plate, 10/case	06-0500-57	Magnifying lens 2.0.	16-1599-28	Face seal for FlexView HWR
04-0270-01	Outer protection plate, standard, 10/case.	06-0500-58	Magnifying lens 2.5.	18-0099-68	Ear and neck protection in leather.
04-0270-03	Outer protection plate, scratch resistant, 5/case.	06-0500-59	Magnifying lens 3.0.		
04-0270-04	Outer protection plate, heat resistant, 5/case.	06-0700-83	Hood black/grey.		
04-0280-00	Inner cover plate, +1 Shade, for 9002D/9002V Filters, 5/case.	07-0024-02	Sweatband, towelling, 2/case.		
04-0280-01	Inner cover plate, +1 Shade, for 9002X/9000XF Filters, 5/case.	14-0099-28	Face seal 9000HWR		
		14-0099-29	HWR/FA II 9000 Headband assembly with air duct		
		14-0099-32	Inner shell 9000HWR, without SideWindows, without airduct.		

\* Please use Part No 14-0099-32SW or 15-1699-32SW to replace the SideWindows.

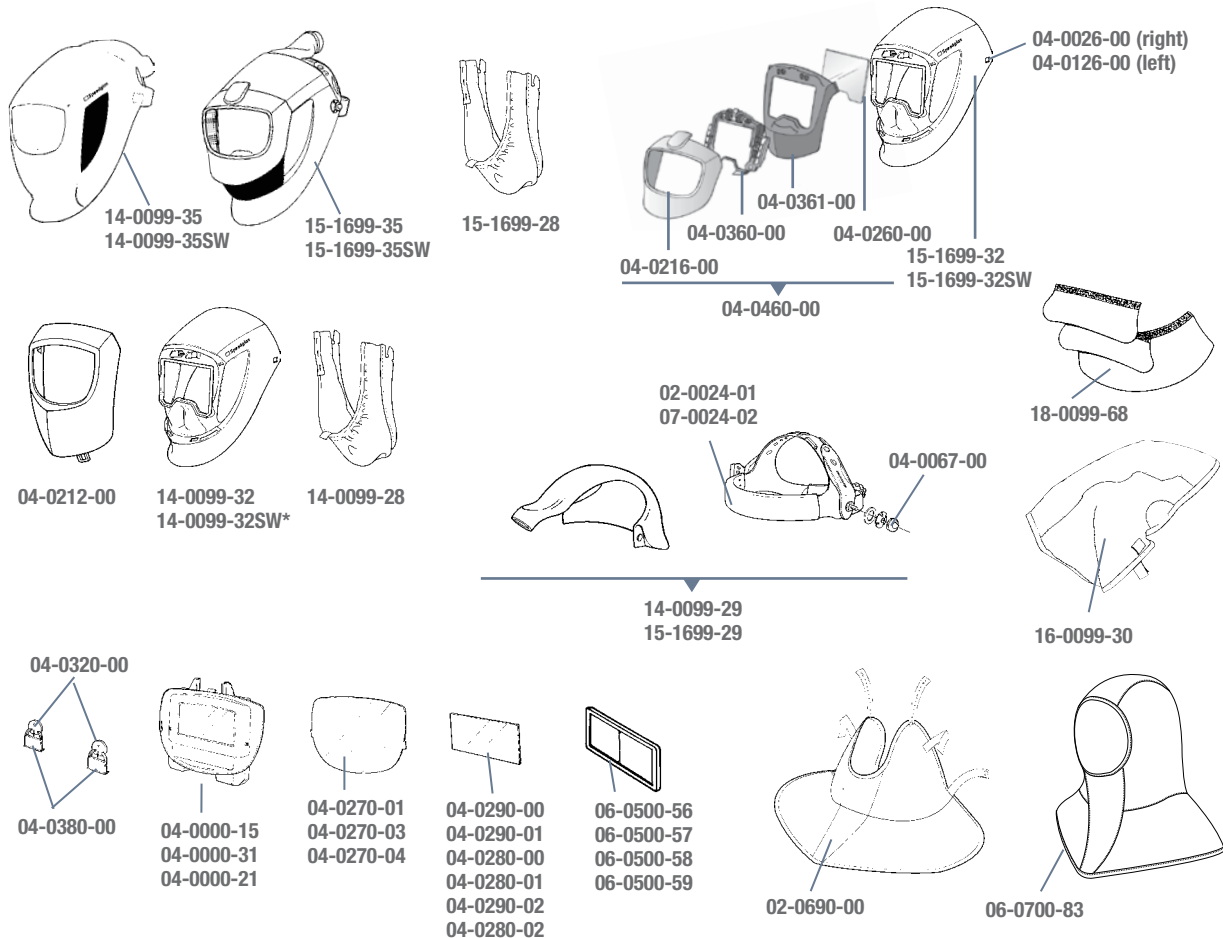



# 3M™ Welding Helmets L-Series for 3M™ Adflo™ PAPR



Part No	Description	Part No	Description	Part No	Description
16-0705-SGV	Adflo Respirator High Efficiency System, with 3M Hard Hat L-705SG Wideview Faceshield and Speedglas Auto-Darkening Filter 9100V	16-0705-SGXX	Adflo Respirator High Efficiency System, with 3M Hard Hat L-705SG Wideview Faceshield and Speedglas Auto-Darkening Filter 9100XX	16-0905-SGX	Adflo Respirator High Efficiency System, with 3M Helmet L-905SG, Wideview Faceshield and Speedglas Auto-Darkening Filter 9100X
16-0705-SGX	Adflo Respirator High Efficiency System, with 3M Hard Hat L-705SG Wideview Faceshield and Speedglas Auto-Darkening Filter 9100X	16-0905-SGV	Adflo Respirator High Efficiency System, with 3M Helmet L-905SG, Wideview Faceshield and Speedglas Auto-Darkening Filter 9100V	16-0905-SGXX	Adflo Respirator High Efficiency System, with 3M Helmet L-905SG, Wideview Faceshield and Speedglas Auto-Darkening Filter 9100XX

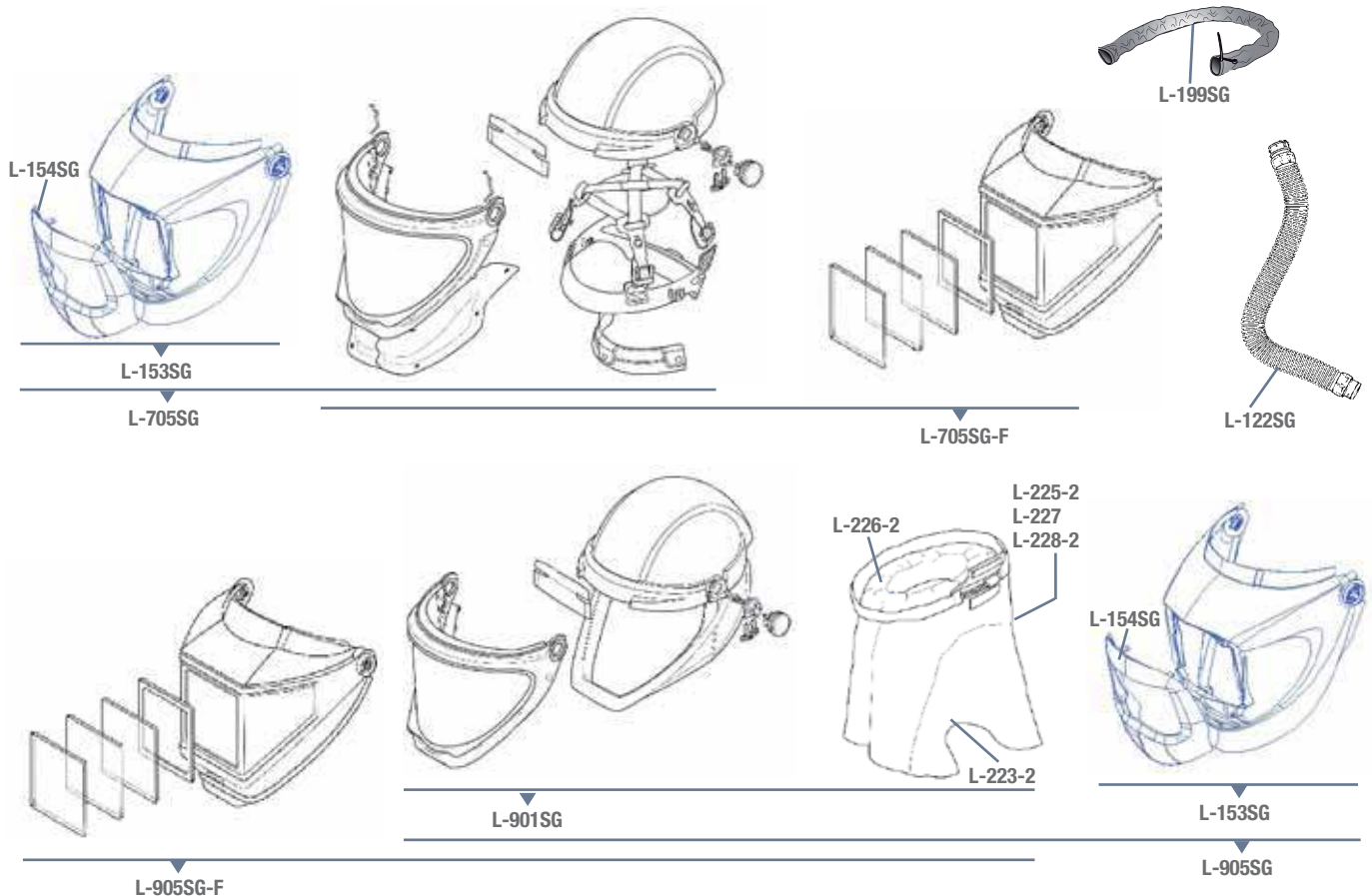

## Accessories and consumables 3M™ Welding Helmets L-Series

Part No	Description	Part No	Description	Part No	Description
L-705SG	Harhat with welding shield and Wideview faceshield (No ADF)	15-0099-20	Adflo flow indicator rubber adapter for SG type systems	L-223-2	Outer shroud standard QC
L-705SG-F	Harhat with welding shield and Wideview faceshield	15-0099-21	Adflo flow indicator for SG type systems	L-225-2	Outer shroud, flame retardant, durable
L-901SG	Helmet with Wideview faceshield	15-5401-02SG	Adflo PAPR assembly	L-226-2	Inner shroud
L-905SG	Helmet with welding shield and Wideview faceshield (No ADF)	L-122SG	Breathing tube	L-227	Outer shroud, flame retardant, leather
L-905SG-F	Helmet with welding shield and Wideview faceshield	L-153SG	Weld shield kit	L-228-2	Outer shroud, nylon
		L-154SG	Silver front panel		
		L-199SG	Breathing tube cover, high temp.		

# 3M™ ClearVisor with 3M™ Adflo™ PAPR



16-1101-40 / 16-3301-40

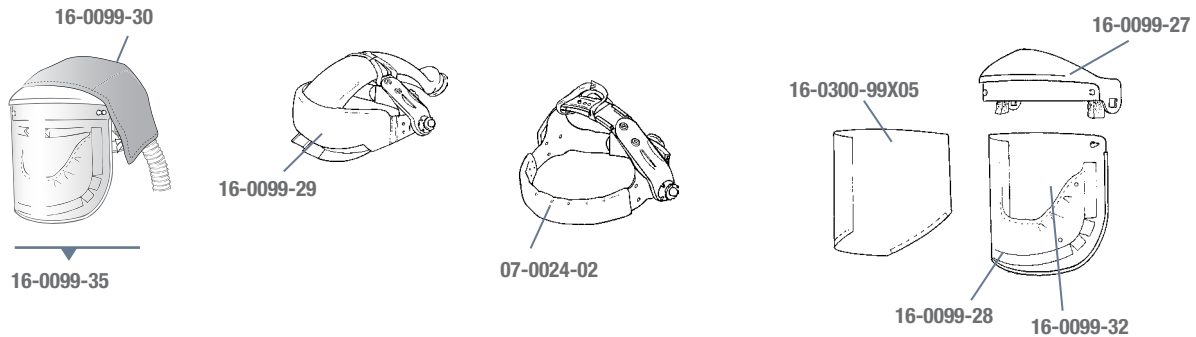

Part No	Description	Part No	Description	Part No	Description
07-0024-02	Sweatband, towelling 2/case	16-0099-32	ClearVisor polycarbonate, with face seal, without brow protection	16-1101-40	ClearVisor, faceshield assembly with Adflo PAPR and HE Particle filter
16-0099-27	Brow protection	16-0099-35	ClearVisor faceshield assembly	16-3301-40	ClearVisor, faceshield assembly with Adflo PAPR, HE Particle filter and OV/AG cartridge
16-0099-28	Face seal	16-0300-99X05	Protection film, 5/case		
16-0099-29	Headband, with air duct				
16-0099-30	Head protection flame-resistant				

# Care and Maintenance

Every day welding sparks, heat, fumes, and normal wear-and-tear grind away at your protection equipment. Therefore, we designed all 3M™ Speedglas™ Personal Protective Equipment with ease of maintenance in mind. All replacement parts can be installed by hand, without tools. For maximum safety and comfort, make it a regular habit to check and change the following items at the intervals recommended below.



System	Component	Typically replaced	Notes
Welding Filters	Outside Protection Plate	Once a week	Replace anytime the plate becomes deeply pitted, scratched or too dirty to clean with soft cloth or lens paper.
Welding Filters	Inside Protection Plate	Once a month	Regularly clean with a soft cloth and replace if any pits or scratches occur.
Welding Helmets	Visor Plate	Every two weeks	Replace more often if visibility is reduced.
Welding Helmets	Sweatband	Once a month	Replace more often if sweatband becomes unhygienic.
PAPR	Prefilter	Once a week	Regular replacement of the prefilter extends the life of the particle filter, saving money while also increasing the battery run-time.
PAPR	Particle Filter	At least every month	For Adflo, replace when particle filter indicator becomes red. Otherwise, replace whenever the battery operating time becomes too short, or when "fully loaded" filter triggers low airflow alarm.
PAPR	OV/AG Cartridge	At least every 3 or 4 weeks	Immediately replace the cartridge any time you can smell odors while wearing the PAPR.
PAPRs	Spark arrestor	As needed	Replace if deformed and no longer fitting well.
Respirators	Breathing Tube	If damaged, deformed or leaking any air	To extend the life of breathing tube, use a tube cover or a heavy-duty rubber breathing tube.
Welding Helmets with PAPRs	Face Seal	At least every 2 months	Replace earlier in really dirty environments or whenever the seal becomes unhygienic.

Important information. Note that higher-than-normal levels of pollutants, heat, and sparks will require more frequent replacement of components. Chart assumes minimum 4 hours usage per day. Ordering information for each series of welding helmet can be found in the Parts Directory.

# Where Do We Find Our Inspiration? We Learn From the Best.

Based on our extensive know-how and our long experience of welders' working conditions, we constantly emphasise innovation in developing equipment that will increase welding performance.

To give us your comments, and to see our latest developments, visit [www.speedglas.com](http://www.speedglas.com).



VISIT THE WORLD OF THE WELDER AT [WWW.SPEEDGLAS.COM](http://WWW.SPEEDGLAS.COM)

## **⚠WARNING**

This product is designed to help protect the wearer's eyes and face from harmful radiation including visible light, ultra-violet radiation (UV), infra-red radiation (IR), sparks and spatter resulting from welding processes. These products must be used only by qualified persons who are properly trained in their use and maintenance. Misuse may result in permanent eye injury and vision loss. Always wear ANSI Z87.1 compliant safety spectacles in addition to any welding helmet. For proper use, see supervisor, or User Instructions or call 3M in U.S.A. 1-800-243-4630. In Canada, call Technical Service at 1-800-267-4414.

## **⚠WARNING**



These respirators help protect against certain airborne contaminants. Before use, the wearer must read and understand the User Instructions provided as a part of the product packaging. A written respiratory protection program must be implemented meeting all the requirements of OSHA 1910.134 including training, fit testing and medical evaluation. In Canada, CSA standards Z94.4 requirements must be met and/or requirements of the applicable jurisdiction, as appropriate. Misuse may result in sickness or death. For proper use, see packaging instructions, supervisor, or call 3M OH&ESD Technical Service in USA at 1-800-243-4630 and in Canada at 1-800-267-4414.

**3M**

### **Occupational Health and Environmental Safety Division**

3M Center  
Building 235-2W-70  
St. Paul, MN 55144-1000

### **3M Canada Company OH&ESD**

P.O. Box 5757  
London, Ontario N6A 4T1  
Canada

### **For More Information**

Technical Assistance in US 1-800-243-4630  
Technical Assistance in Canada 1-800-267-4414

3M, Adflo, Speedglas and Vortemp are trademarks of  
3M Company, used under license in Canada.

Please recycle. Printed in U.S.A.  
© 3M 2012. All rights reserved.