



# EV3924-U-00A

## Quad Port IEEE 802.3af/at PSE Controller for Power over Ethernet Evaluation Board

### DESCRIPTION

EV3924-U-00A Evaluation Board is designed to demonstrate the capability of MP3924. The MP3924 is a quad power-source equipment (PSE) power controller for IEEE 802.3af/at compliant power over Ethernet (PoE).

MP3924 has all the functions of IEEE 802.3af/at, including detection, 1-event and 2-event classification, current limit and load disconnect detection. All the functions can work in automatic operation mode or software program mode through I<sup>2</sup>C control.

MP3924 features with 9-bit ADC converter for current/voltage monitor, special I<sup>2</sup>C interface for isolated controller communication, different current limit level and programmable system function.

The MP3924 is available in 32-pin QFN 5mmx5mm package.

### ELECTRICAL SPECIFICATIONS

Parameter	Symbol	Value	Unit
Input Voltage	V <sub>IN</sub>	44-57	V
Output Voltage	V <sub>OUT</sub>	0-57	V
Output Power	P <sub>OUT</sub>	4 x 0-30	W

### FEATURES

- 44V-to-57V Input Voltage
- IEEE802.3af/at Compliant PD Load
- Quad Port and 4-bit Programmable I<sup>2</sup>C Address
- 0.25Ω Current Sense Resistor
- Automatic Mode and I<sup>2</sup>C Command Control Mode
- Auto Over Input Power Shutdown
- Internal V<sub>CC</sub> Power Supply
- 3-wire I<sup>2</sup>C Interface for Isolated Application
- Two INT Pins for Interrupt Priority Selection
- DC Load Disconnect Detection
- Instantaneous Current/voltage Readout
- Thermal Protection
- Available in QFN-32(5mm×5mm) Package

### APPLICATIONS

- PSE Switches/Routers
- PSE Midspan Power Injector
- Surveillance NVR and DVRs

All MPS parts are lead-free, halogen free, and adhere to the RoHS directive. For MPS green status, please visit MPS website under Quality Assurance. "MPS" and "The Future of Analog IC Technology" are Registered Trademarks of Monolithic Power Systems, Inc.

### EV3924-U-00A EVALUATION BOARD



(L x W x H) (11cm x 9.2cm x 2.3cm)

Board Number	MPS IC Number
EV3924-U-00A	MP3924GU

Power up for Class-4 PD

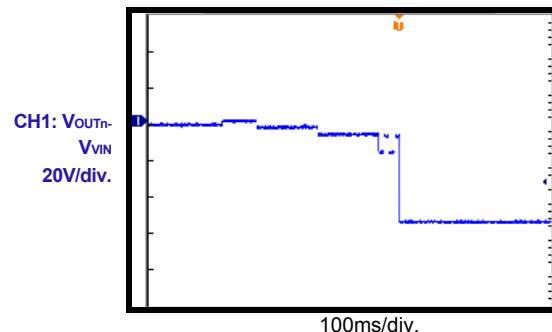

### EVALUATION BOARD SCHEMATIC

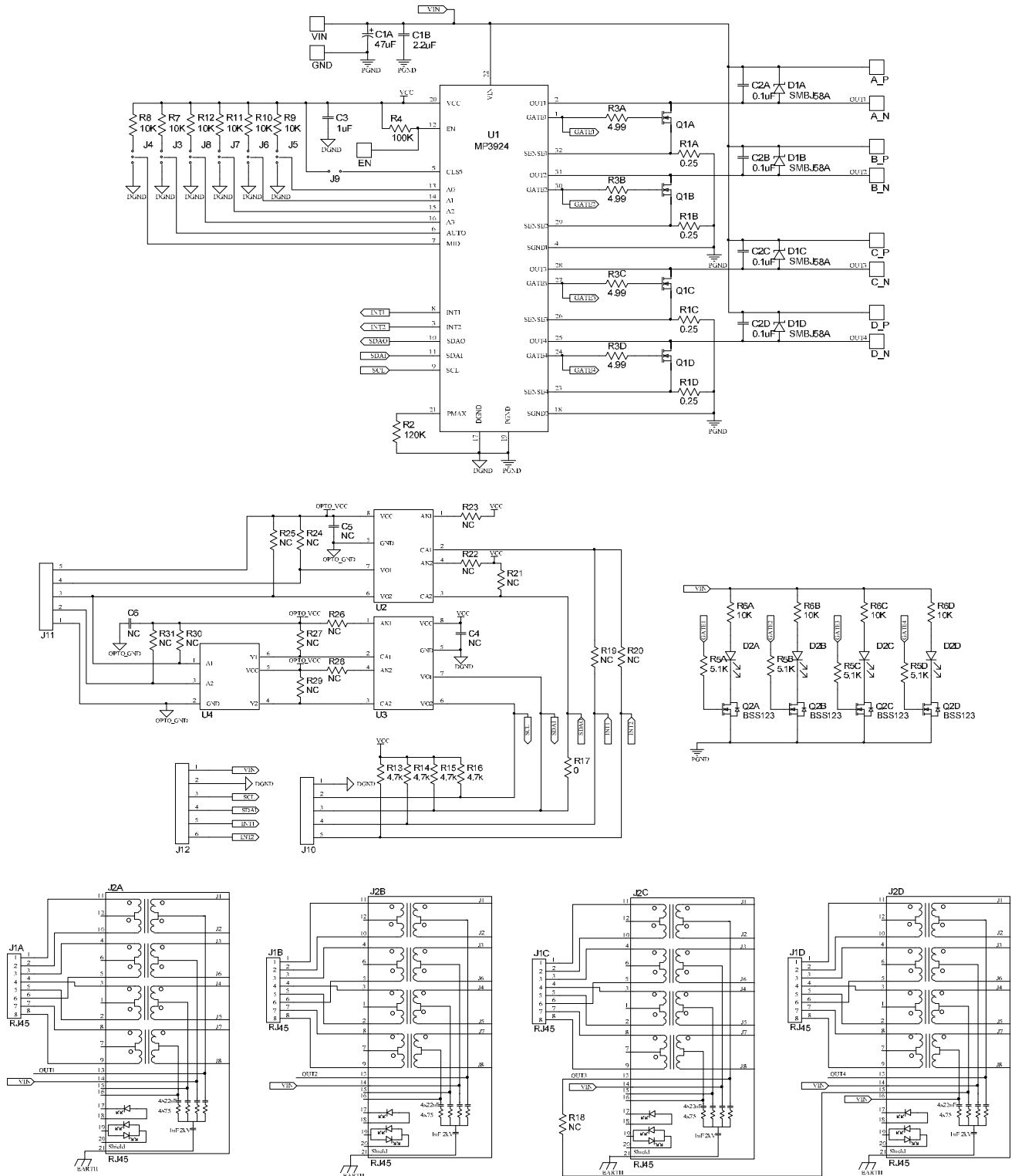

**EV3924-U-00A BILL OF MATERIALS**

Qty	Ref	Value	Description	Package	Manufacturer	Part Number
1	C1A	47uF	CD284, 100V E-cap	DIP	JiangHai	ECR2AXY470M100012
1	C1B	2.2uF	Ceramic Cap.,100V,X7R	1210	muRata	GRM32ER72A225KA88L
4	C2A, C2B, C2C, C2D	0.1uF	Ceramic Cap.,100V,X7R	0805	muRata	GRM21BR72A104KA01D
1	C3	1uF	Ceramic Cap.,10V,X7R	0805	muRata	GRM21BR71A105KA01D
0	C4, C5, C6, R18, R19, R20, R21, R22, R23, R24, R25, R26, R27, R28, R29, R30, R31, J11, U2, U3, U4	NC				
4	D1A, D1B, D1C, D1D	SMBJ58A	TVS 58V	SMB	Diode.Inc	SMBJ58A
4	D2A, D2B, D2C, D2D	LED	Red LED	0805	Wurth	150080RS75000
4	J1A, J1B, J1C, J1D	RJ45 Jack	WR-MJ Female Plastic	DIP	Wurth	615008138021
4	J2A, J2B, J2C, J2D	RJ45 Jack	RJ45 Int XFMR	DIP	Wurth	7499511611A
6	J3, J4, J5, J6, J7, J8	3pin Jack	2.54mm, straight	DIP	Wurth	61300311121
1	J9	2pin Jack	2.54mm, straight	DIP	Wurth	61300211121
1	J10	5pin Jack	2.54mm, straight	DIP	Wurth	61300511121
1	J12	6pin Jack	2.54mm, right angled	DIP	Wurth	61300611021
4	Q1A, Q1B, Q1C, Q1D	FDMC3612	N-CH 100V 12A	Power 33	Fairchild	FDMC3612
4	Q2A, Q2B, Q2C, Q2D	BSS123	N-CH 100V 170mA	SOT-23	Fairchild	BSS123
4	R1A, R1B, R1C, R1D	0.25	Film Res.,1%	1206	ROYAL	PT1206FR-070R25L
1	R2	120K	Film Res.,1%	0603	ROYAL	RC0603FR-07120KL
4	R3A, R3B, R3C, R3D	4.99	Film Res.,1%	0603	ROYAL	RC0603FR-074R99L
1	R4	100K	Film Res.,1%	0603	ROYAL	RC0603FR-07100KL
4	R5A, R5B, R5C, R5D	5.1K	Film Res.,1%	0603	ROYAL	RC0603FR-075K1L
10	R6A, R6B, R6C, R6D, R7, R8, R9, R10, R11, R12	10K	Film Res.,1%	0603	ROYAL	RC0603FR-0710KL
4	R13, R14, R15, R16	4.7k	Film Res.,1%	0603	ROYAL	RC0603FR-074K7L
1	R17	0	Film Res.,1%	0603	ROYAL	RC0603FR-070RL
1	U1	MP3924	PSE Controller	QFN 5x5	MPS	MP3924GU

### EVB TEST RESULTS

$V_{IN} = 54V$ , Set with Class 4 PD load,  $T_A = 25^{\circ}C$ , unless otherwise noted.

No PD Connect

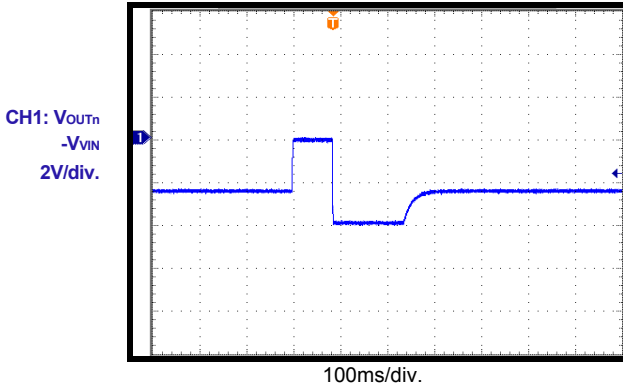

Class0-3 PD Connect

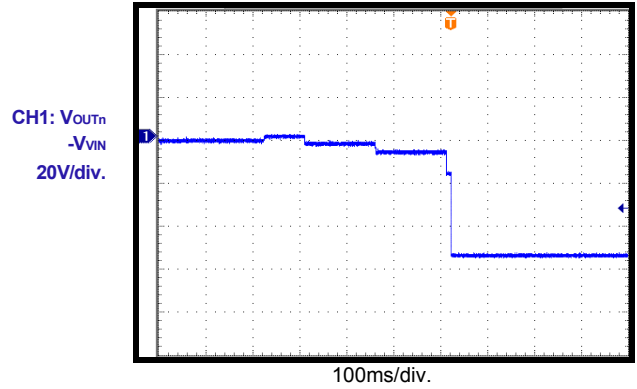

Class4 PD Connect

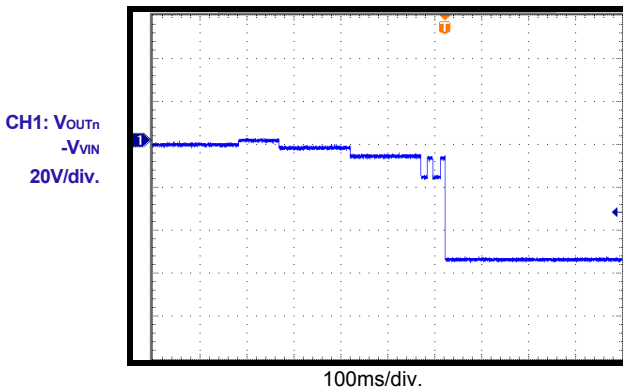

Vin Startup

No PD connect

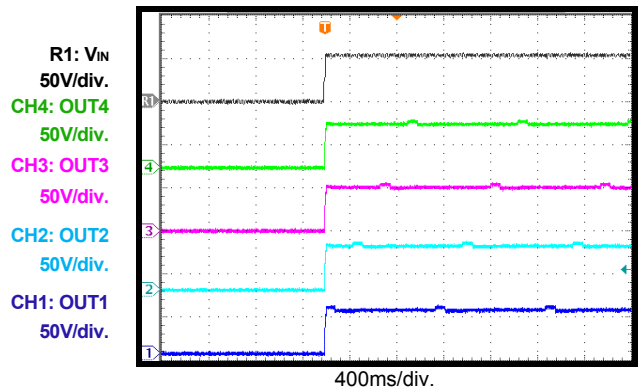

Vin Startup

Class4 PD connect

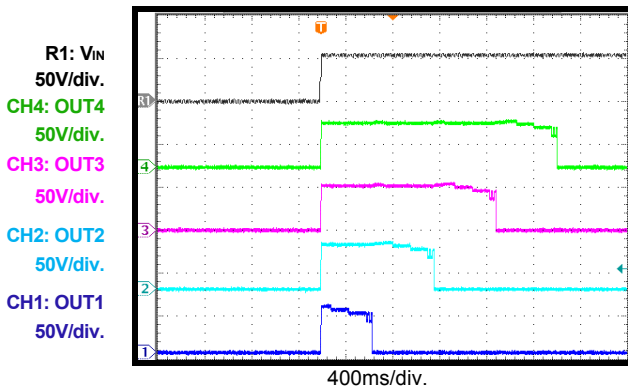

Vin Shutdown

No PD connect

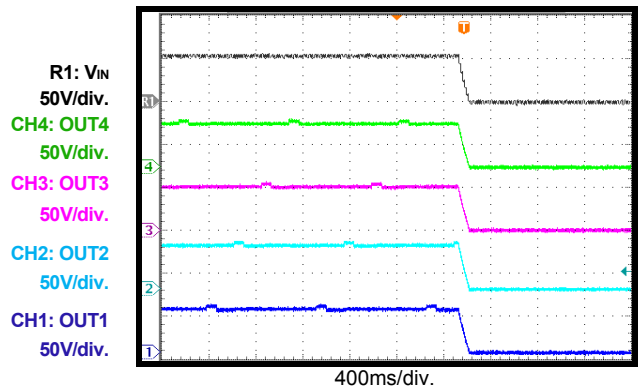

**EVB TEST RESULTS (continued)**

$V_{IN} = 54V$ , Set with Class 4 PD load,  $T_A = 25^{\circ}C$ , unless otherwise noted.

**Vin Shutdown**  
Class4 PD connect

R1:  $V_{IN}$   
50V/div.  
CH4: OUT4  
50V/div.  
CH3: OUT3  
50V/div.  
CH2: OUT2  
50V/div.  
CH1: OUT1  
50V/div.

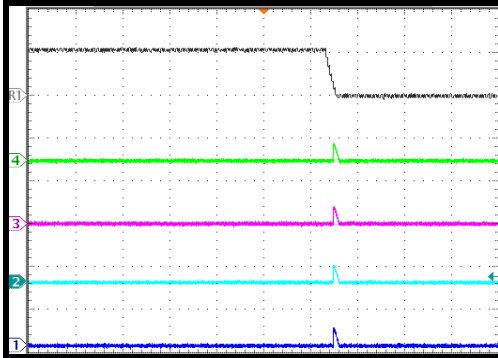

400ms/div.

**EN Startup**  
No PD connect

R1:  $V_{EN}$   
2V/div.  
CH4: OUT4  
50V/div.  
CH3: OUT3  
50V/div.  
CH2: OUT2  
50V/div.  
CH1: OUT1  
50V/div.

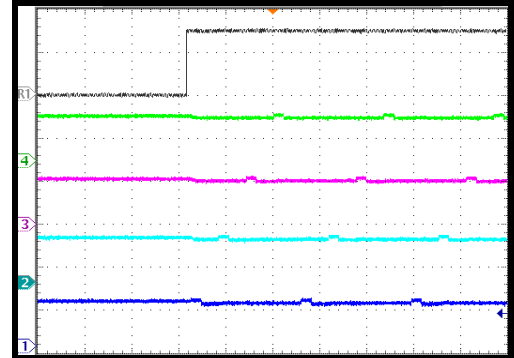

400ms/div.

**EN Startup**  
Class4 PD connect

R1:  $V_{EN}$   
2V/div.  
CH4: OUT4  
50V/div.  
CH3: OUT3  
50V/div.  
CH2: OUT2  
50V/div.  
CH1: OUT1  
50V/div.

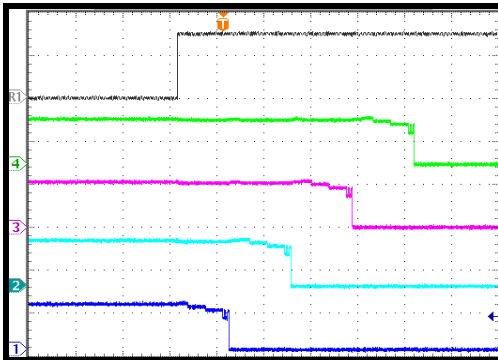

400ms/div.

**EN Shutdown**  
No PD connect

R1:  $V_{EN}$   
2V/div.  
CH4: OUT4  
50V/div.  
CH3: OUT3  
50V/div.  
CH2: OUT2  
50V/div.  
CH1: OUT1  
50V/div.

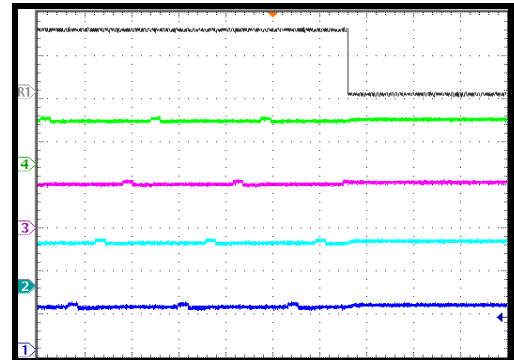

400ms/div.

**EN Shutdown**  
Class4 PD connect

R1:  $V_{EN}$   
2V/div.  
CH4: OUT4  
50V/div.  
CH3: OUT3  
50V/div.  
CH2: OUT2  
50V/div.  
CH1: OUT1  
50V/div.

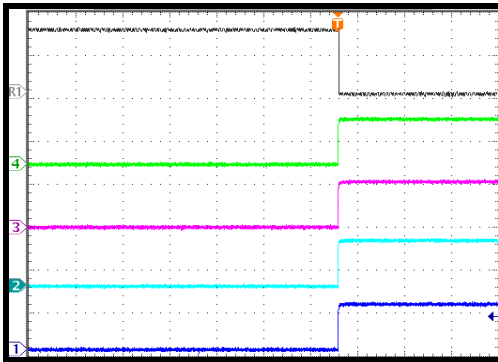

400ms/div.

**Over P<sub>MAX</sub> is triggered <sup>(1)</sup>**  
R2=49.9K

R1:  $I_{IN}$   
500mA/div.  
CH4: OUT4  
50V/div.  
CH3: OUT3  
50V/div.  
CH2: OUT2  
50V/div.  
CH1: OUT1  
50V/div.

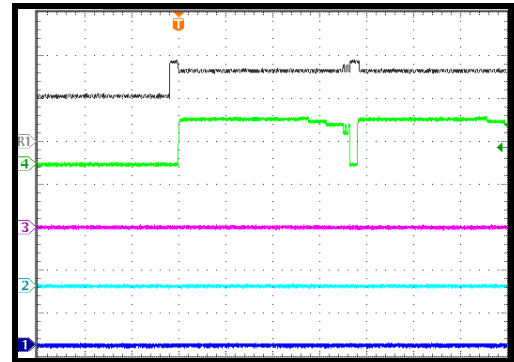

400ms/div.

**Notes:**

1) Maximum Power is set at 49.9W, after load power exceed 49.9W, port 4 shutdown with default priority.

**EVB TEST RESULTS (continued)**

$V_{IN} = 54V$ , Set with Class 4 PD load,  $T_A = 25^{\circ}C$ , unless otherwise noted.

**ICUT is triggered**

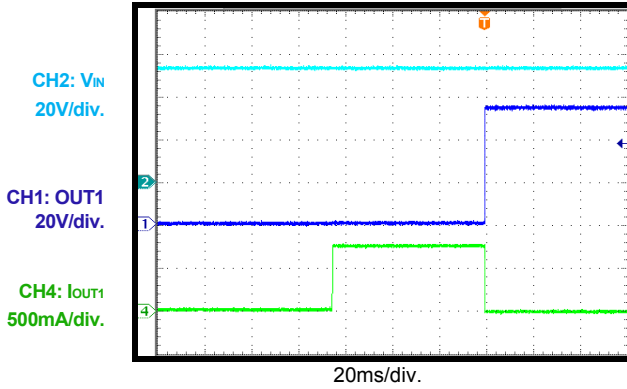

**ILIM is triggered**

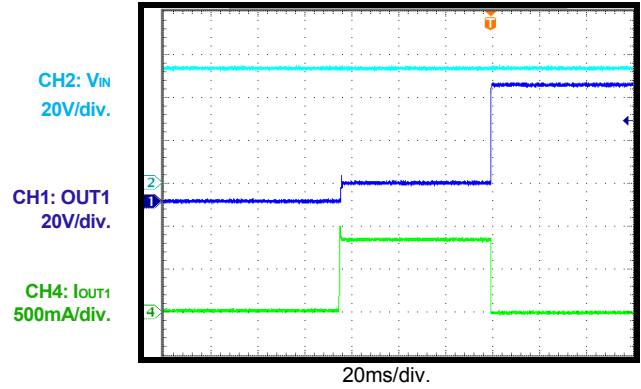

**Output SCP is triggered**

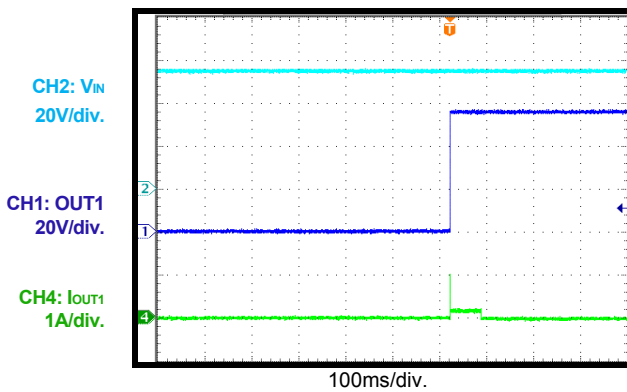

**Inrush current Limit is triggered**

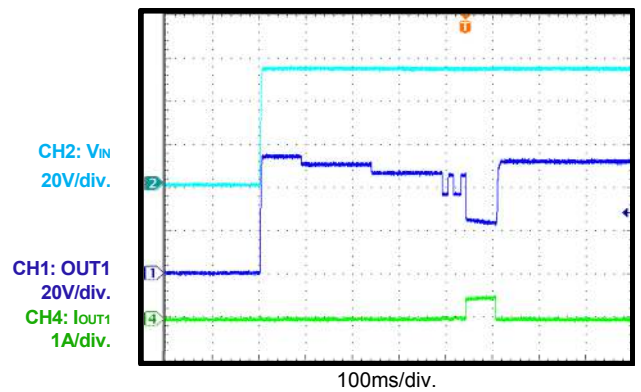

**Output disconnect is triggered**

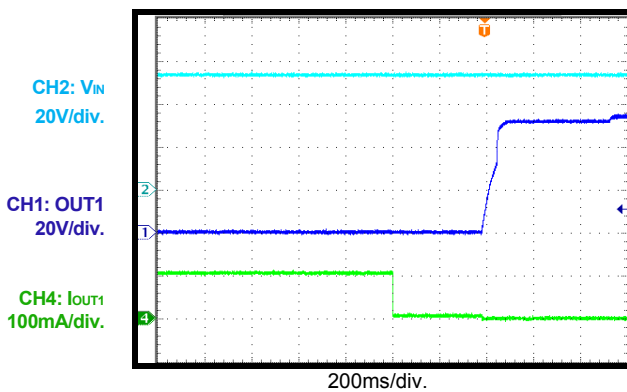

### PRINTED CIRCUIT BOARD LAYOUT

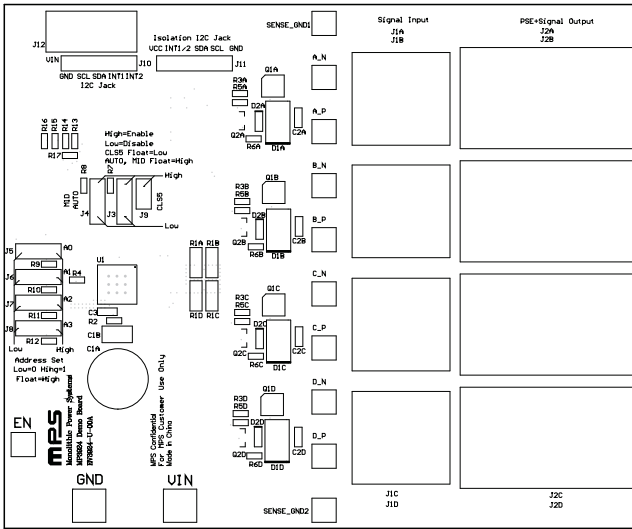

Figure 1: Top Silk Layer

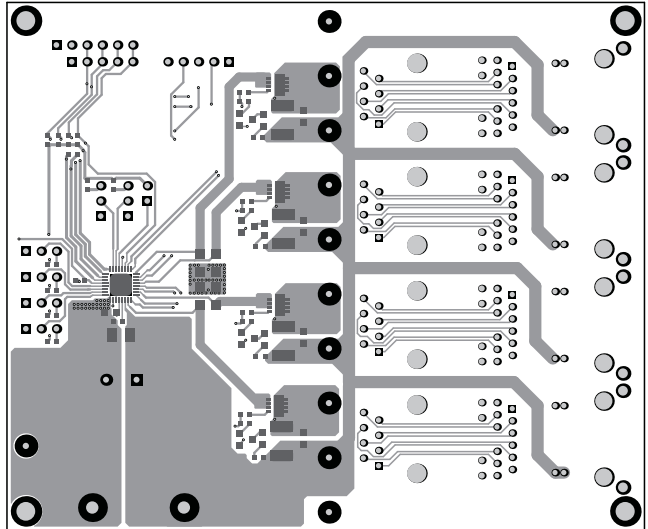

Figure 2: Top Layer

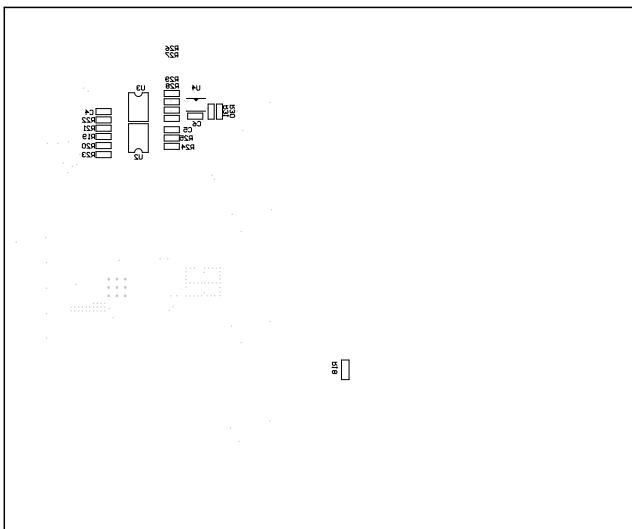

Figure 3: Bottom Silk Layer

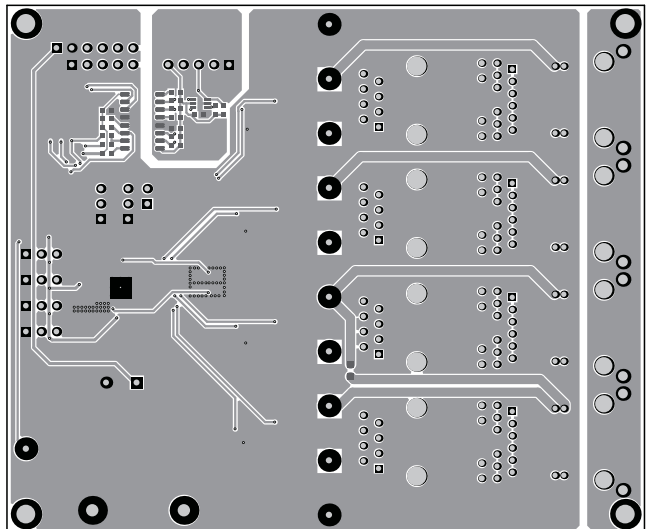

Figure 4: Bottom Layer

## QUICK START GUIDE

### 1. Board Set-Up

1. Preset the power supply between 44V and 57V.
2. Turn the power supply off.
3. Connect the power supply terminals to:
  - a. Positive (+): VIN
  - b. Negative (-): GND
4. Turn the power supply on after making the connections.
5. Connect the PD in RJ45 Jack, MP3924 will power PD automatically.

### 2. Software Set-Up

After connecting the hardware with above steps, follow the below steps can use the GUI software.

1. Install the MP3924 GUI software.
2. Connect the SCL, SDA, and GND to the EVKT-USB12C-02 communication interface device.
3. Use the USB cable to connect the EVKT-USB12C-02 communication interface device to the PC.
4. Start the software. It will check the EVB connection automatically, select MP3924 from under Part Numbers.
5. Find the item you want to change and select the desired value from the drop-down menu.

For More details information, please check the MP3924 EVKT User Guide.

**NOTICE:** The information in this document is subject to change without notice. Please contact MPS for current specifications. Users should warrant and guarantee that third party Intellectual Property rights are not infringed upon when integrating MPS products into any application. MPS will not assume any legal responsibility for any said applications.