

Tous droits strictement réservés. Reproduction ou communication o des tiers interdite sous quelque forme que ce soit sans autorisation écrite du propriétaire. Propriete de c FCI. Droits de reproduction FCI.

All rights strictly reserved. Reproduction or issue to third parties in any form whatever is not permitted without written authority from the proprietor. Property of FCI. Copyright FCI.

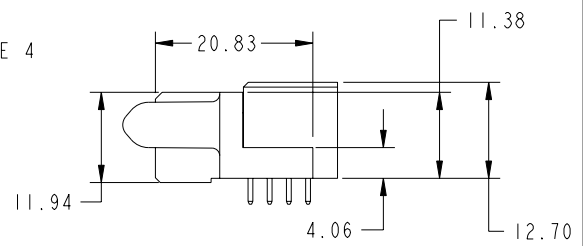

PRODUCT NO. 51923-005-- NOTE: 3	ROWS D C B A	SIGNAL					POWER					E1			
		E2	6	5	4	3	2	1	P7	P6	P5		P4	P3	P2
		H	H	H	H	H	PC	PC	PC	PC	PG	PH	PH		
		G	G	G	G	G									
		F	F	F	F	F									
		E	E	E	E	E									

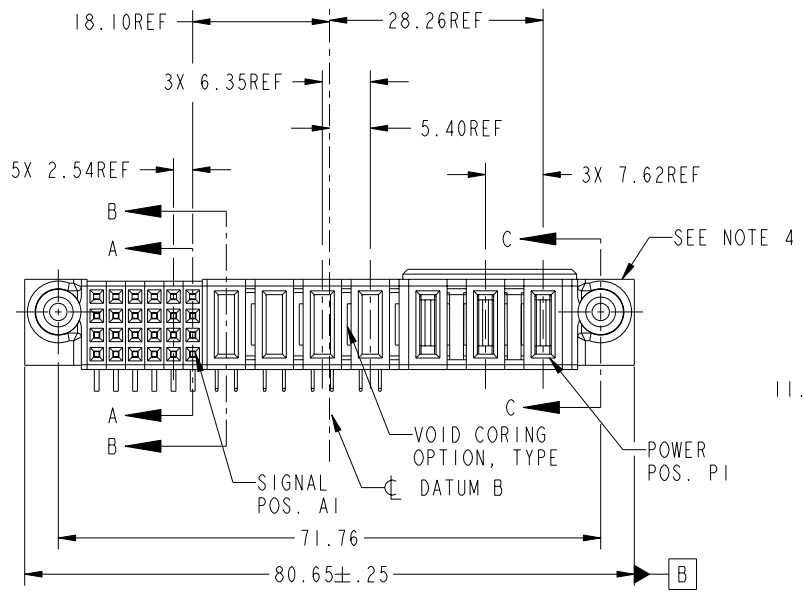
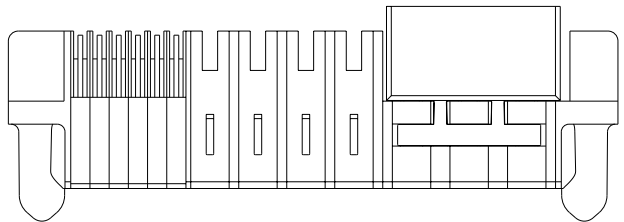

CODE	DIM "M" MATING LENGTH	CONTACT TYPE
PG	[1.07]	POWER
PC	[2.34]	POWER
H	[N/A]	SIGNAL
G	[N/A]	SIGNAL
F	[N/A]	SIGNAL
E	[N/A]	SIGNAL
PH	[2.34]	POWER

mat'l code				SEE NOTE		tolerances unless otherwise specified		CUSTOMER		FCI www.fciconnect.com	
ltr	ecn no.	dr	date	linear	0.X ± 0.3		COPY		title 3ACP + 4P + 24S R/A SOLDER RECEPTACLE		
A	DG06-0438	JULIA	10/27/06		0.XX ± 0.13		projection				
				angles	0.XXX ± 0.051		MM		product family PwrBlade code		
					0° ± 2°		scale 1:1		size 213		
				dr	JULIA WANG	10/27/06			sheet 1 of 4		
				engr	RYAN YUAN	10/27/06			size A 51923-005		
				chr	BEER FU	10/27/06			cage code		
				appd	JOSEPH HSIA	10/27/06			22526		
sheet index	revision sheet	A 1	A 2	A 3	A 4						

Pro/E 3 cage code 22526 4

Tous droits strictement reserves. Reproduction ou communication a des tiers interdite sous quelque forme que ce soit sans autorisation ecrite du proprietaire. Propriete de c FCI. Droits de reproduction FCI.

All rights strictly reserved. Reproduction or issue to third parties in any form whatever is not permitted without written authority from the proprietor. Property of FCI. Copyright FCI.



PRODUCT NUMBER

51923-005--
NOTE: 3

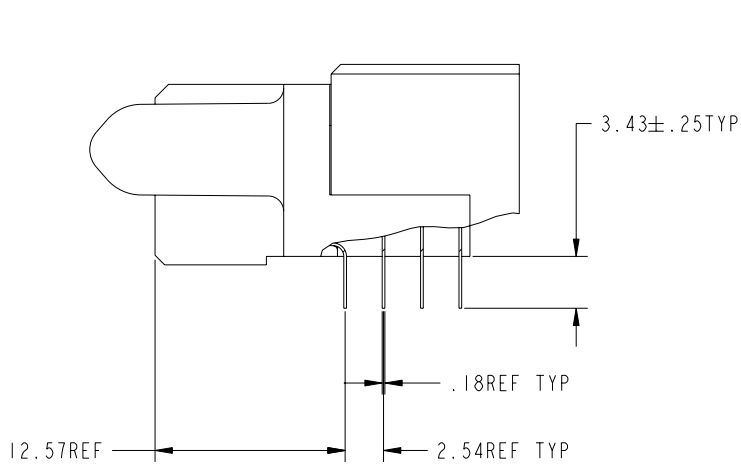

BROKEN-OUT SECTION A-A
SCALE 2:1

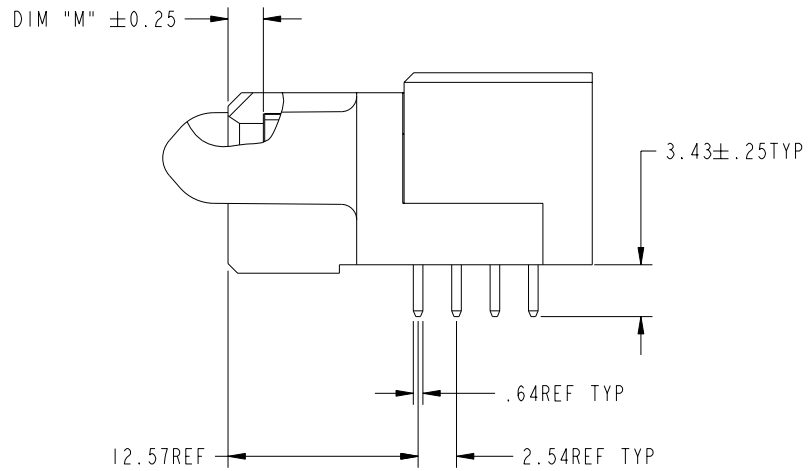

BROKEN-OUT SECTION B-B
SCALE 2:1

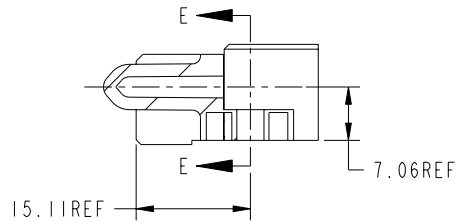

SECTION C-C

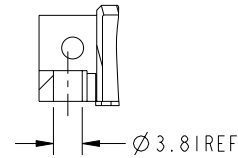

PARTIAL SECTION E-E

mat'l code				SEE NOTE		tolerances unless otherwise specified		CUSTOMER		www.fciconnect.com	
ltr	ecn no.	dr	date	linear	0.X ±0.3	projection		COPY		title	
A					0.XX ±0.13					3ACP + 4P + 24S R/A SOLDER RECEPTACLE	
				angles	0.XXX ±0.051					product family	
				dr	JULIA WANG 10/27/06			MM		PwrBlade	
				enr	RYAN YUAN 10/27/06			size		code	
				chr	BEER FU 10/27/06			A		213	
				appd	JOSEPH HSIA 10/27/06			1:1		sheet	
sheet index		revision sheet								2 of 4	
										cage code	
										22526	

Pro/E

cage code 22526

Tous droits strictement réservés. Reproduction ou communication o des tiers interdite sous quelque forme que ce soit sans autorisation écrite du propriétaire. Propriété de c FCI. Droits de reproduction FCI.



All rights strictly reserved. Reproduction or issue to third parties in any form whatever is not permitted without written authority from the proprietor. Property of FCI. Copyright FCI.

PRODUCT NUMBER

51923-005--
NOTE: 3

NOTES:



1. DIMENSIONS AND TOLERANCES ARE IN ACCORDANCE WITH ASME Y14.5M, 1994 UNLESS OTHERWISE SPECIFIED.

CONNECTOR NOTES:

- 2 HOUSING MATERIAL: UL 94 V-0 GLASS FILLED HIGH-TEMP THERMOPLASTIC
POWER CONTACT MATERIAL: COPPER ALLOY
SIGNAL PIN MATERIAL: COPPER ALLOY
- 3. 51923-005;51923-005LF;51923-005GLF PLATING SPEC. SEE PRINT:10064183
- 4 MANUFACTURER'S NAME, P/N, AND DATE CODE TO APPEAR ON THIS SURFACE.
- 5. PRODUCT SPECIFICATION GS-12-149.
APPLICATION SPECIFICATION BUS-20-067.
- 6. PACKAGED IN TRAYS.

PCB NOTES:

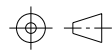
- 7. ALL HOLE DIAMETERS ARE FINISHED HOLE SIZE.
- 8 MOUNTING HOLES, WHERE APPLICABLE, ARE UNPLATED.
- 9 $\varnothing 1.151 \pm 0.025$ DRILLED HOLES PLATED WITH 0.008 MIN SnPb OVER 0.03 TO 0.08 Cu PLATING TO ACHIEVE $\varnothing 1.02 \pm 0.07$ HOLE.
- 10 "DIM XXX" TO BE DETERMINED BY THE CUSTOMER.
- 11 CONNECTOR KEEP-OUT ZONE.

mat'l code		SEE NOTE		tolerances unless otherwise specified		CUSTOMER		 www.fciconnect.com	
ltr	ecn no.	dr	date	linear	0.X ± 0.3	COPY		title	
A					0.XX ± 0.13	projection		3ACP + 4P + 24S R/A SOLDER RECEPTACLE	
				angles	0.XXX ± 0.051			product family	
				dr	0° ± 2°			PwrBlade	
				enr	JULIA WANG 10/27/06	scale		code	
				chr	RYAN YUAN 10/27/06	1:1		213	
				appd	BEER FU 10/27/06	size		sheet	
					JOSEPH HSIA 10/27/06	A		4 of 4	
sheet index	revision sheet								

cage code 22526