

# SMD Power Inductor CDH115



Halogen Free



## Description

- Ferrite drum core construction.
- Magnetically unshielded.
- L × W × H: 11.2 × 11.2 × 5.2 mm Max.
- Product weight: 1.6g(Ref.)
- Moisture Sensitivity Level: 1
- RoHS compliance.
- Halogen Free available.

## Environmental Data

- Operating temperature range: -40°C~+100°C (including coil's self temperature rise)
- Storage temperature range: -40°C~+100°C
- Solder reflow temperature: 260 °C peak.

## Packaging

- Carrier tape and reel packaging.
- 12.9" diameter reel
- 500pcs per reel

## Applications

- Ideally used in Notebook PC ,DVD, LCD TV ,Game machine, Projector etc as DC-DC converter inductors.

## Dimension - [mm]

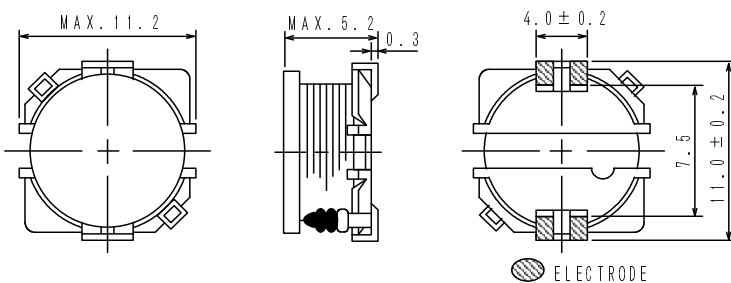

## Land pattern and Schematics - [mm]

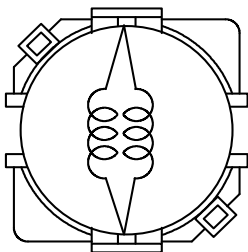
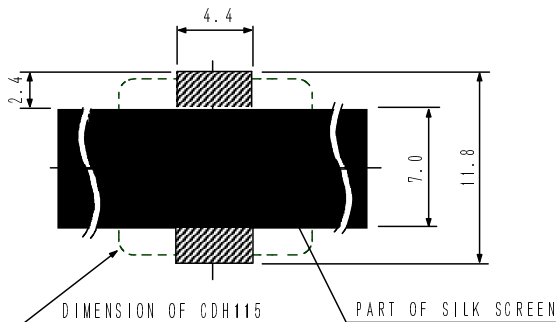

10  $\mu$  H ~ 33  $\mu$  H

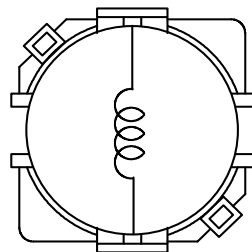

39  $\mu$  H ~ 470  $\mu$  H

# SMD Power Inductor CDH115



## Electrical Characteristics

Part Name	Stamp	Inductance ( $\mu$ H) [ within ] ※1	D.C.R.( $\Omega$ ) Max. (Typ.) (at 20°C)	Rated Current (A) ※2
CDH115NP-100MC	100	10 $\pm$ 20%	28m(22m)	3.00
CDH115NP-120MC	120	12 $\pm$ 20%	33m(25m)	2.80
CDH115NP-150MC	150	15 $\pm$ 20%	39m(30m)	2.50
CDH115NP-180LC	180	18 $\pm$ 15%	49m(38m)	2.25
CDH115NP-220LC	220	22 $\pm$ 15%	60m(46m)	2.10
CDH115NP-270LC	270	27 $\pm$ 15%	70m(54m)	1.84
CDH115NP-330LC	330	33 $\pm$ 15%	82m(63m)	1.68
CDH115NP-390KC	390	39 $\pm$ 10%	0.11(85m)	1.52
CDH115NP-470KC	470	47 $\pm$ 10%	0.13(0.10)	1.36
CDH115NP-560KC	560	56 $\pm$ 10%	0.14(0.11)	1.28
CDH115NP-680KC	680	68 $\pm$ 10%	0.16(0.12)	1.20
CDH115NP-820KC	820	82 $\pm$ 10%	0.21(0.16)	1.04
CDH115NP-101KC	101	100 $\pm$ 10%	0.26(0.20)	0.96
CDH115NP-121KC	121	120 $\pm$ 10%	0.29(0.22)	0.88
CDH115NP-151KC	151	150 $\pm$ 10%	0.40(0.31)	0.76
CDH115NP-181KC	181	180 $\pm$ 10%	0.45(0.35)	0.72
CDH115NP-221KC	221	220 $\pm$ 10%	0.53(0.40)	0.66
CDH115NP-271KC	271	270 $\pm$ 10%	0.73(0.56)	0.59
CDH115NP-331KC	331	330 $\pm$ 10%	0.84(0.65)	0.53
CDH115NP-391KC	391	390 $\pm$ 10%	1.10(0.84)	0.48
CDH115NP-471KC	471	470 $\pm$ 10%	1.24(0.96)	0.45

※1. Inductance measuring condition: at 1kHz.

※2. Rated current: The DC current at which the inductance decreases to 90 % of it's initial value or when  $\Delta t=40^{\circ}\text{C}$ , whichever is lower ( $T_a=20^{\circ}\text{C}$ )

# SMD Power Inductor CDH115



## Saturation Current & Temperature Rise Graph

— L (20°C) — L (100°C) —  $\Delta T$

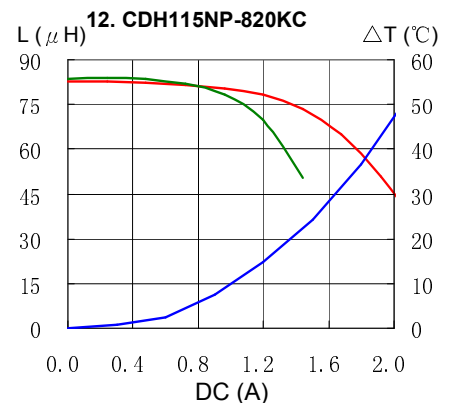
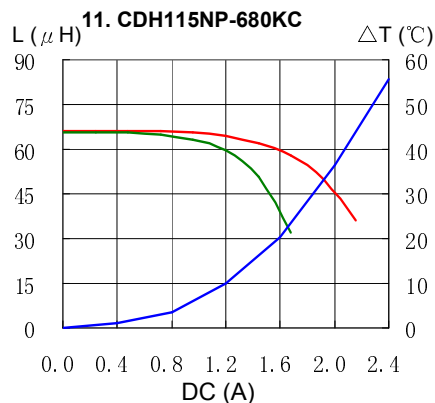
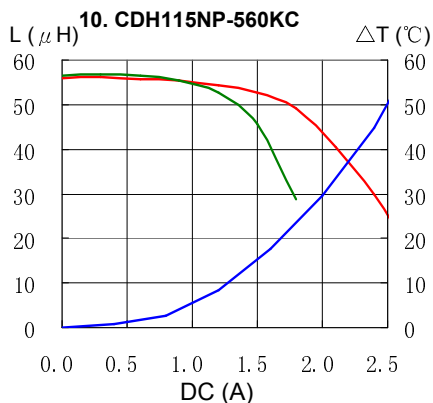
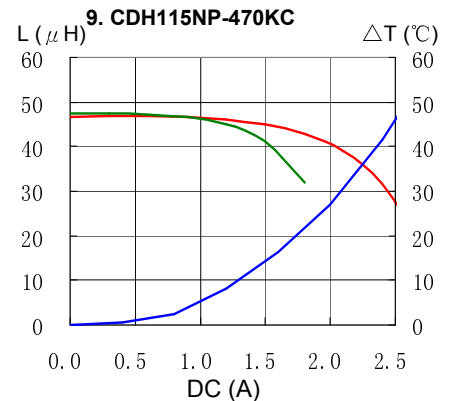
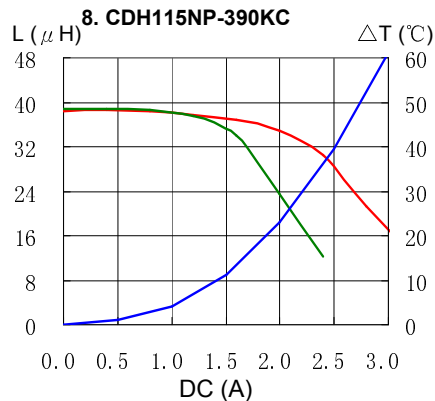
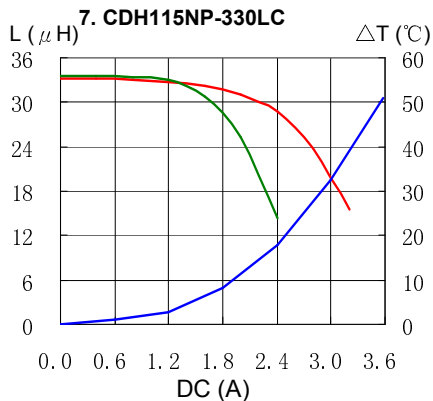
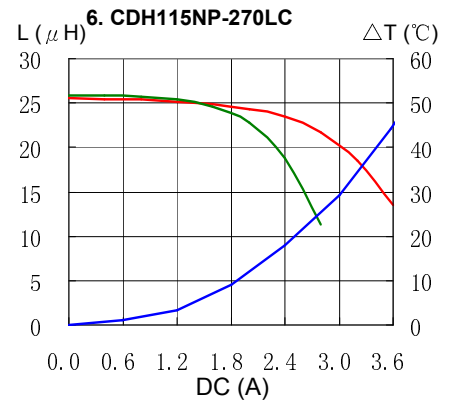
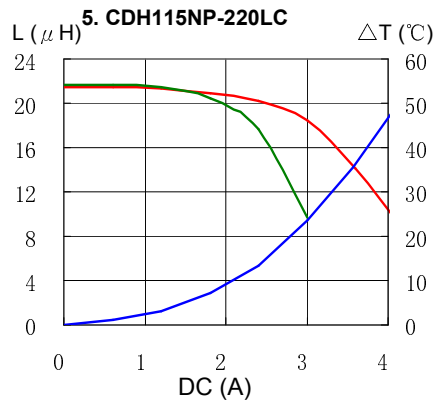
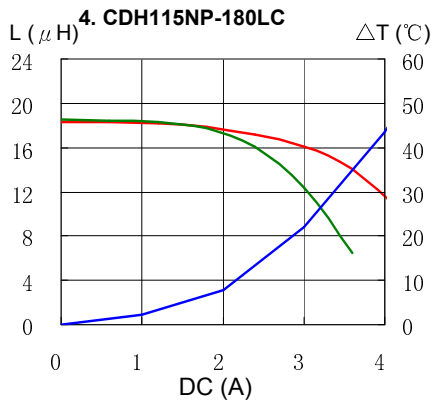
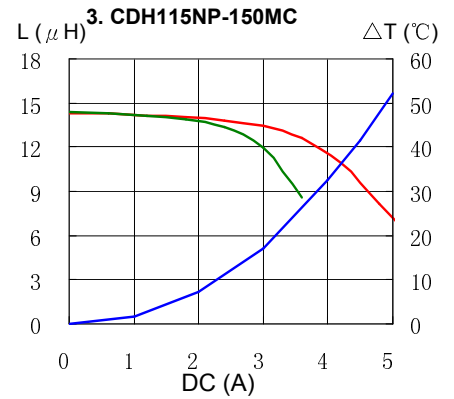
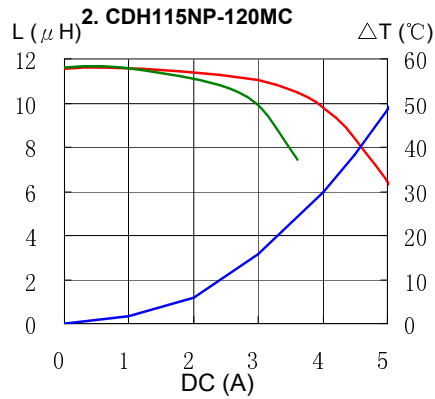
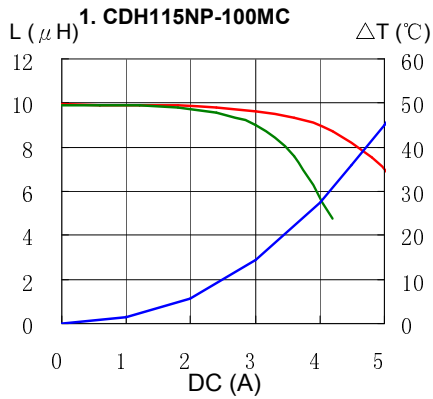

# SMD Power Inductor CDH115



## Saturation Current & Temperature Rise Graph

— L (20°C) — L (100°C) —  $\Delta T$

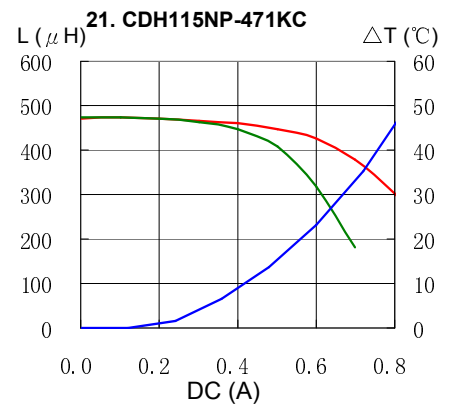
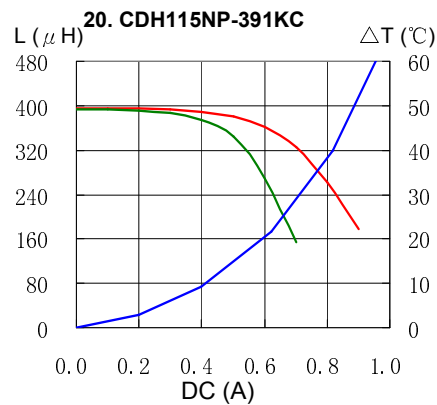
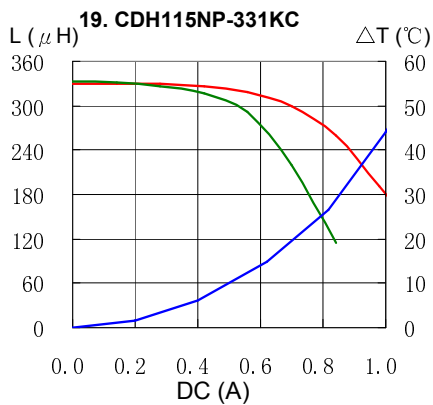
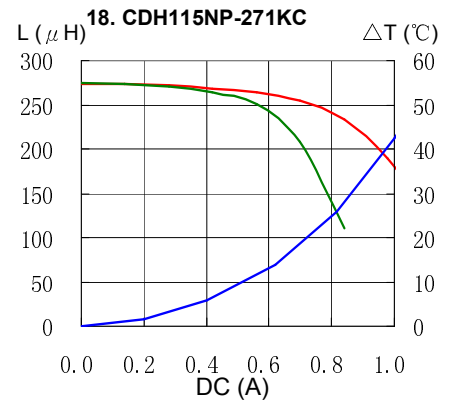
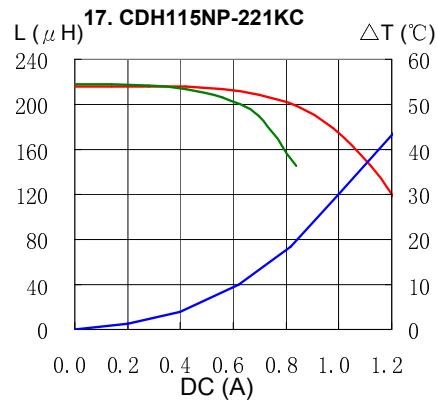
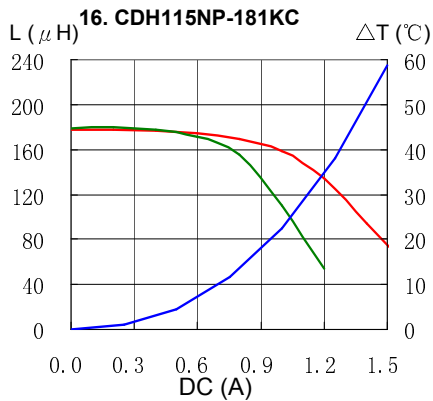
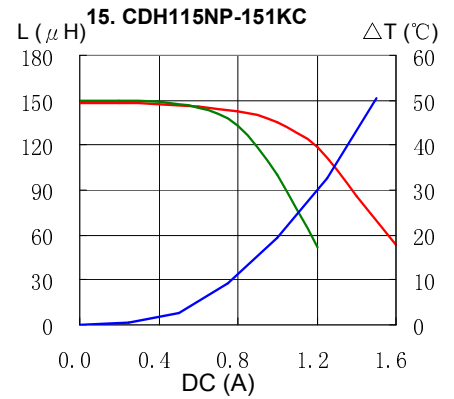
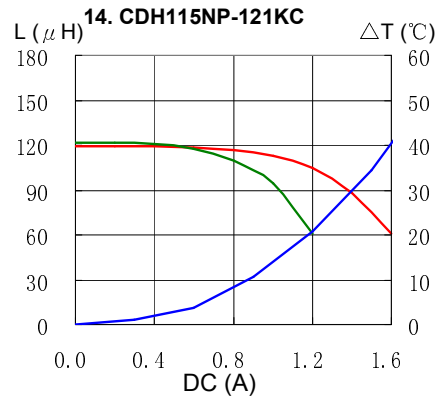
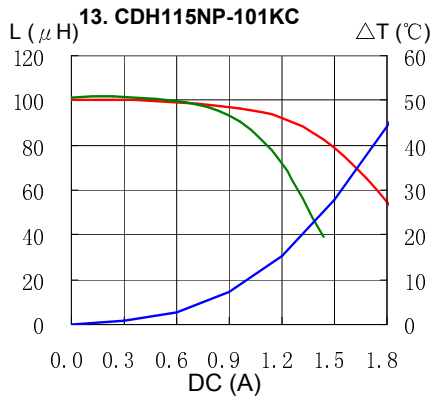

# SMD Power Inductor CDH115



## Solder Reflow Condition

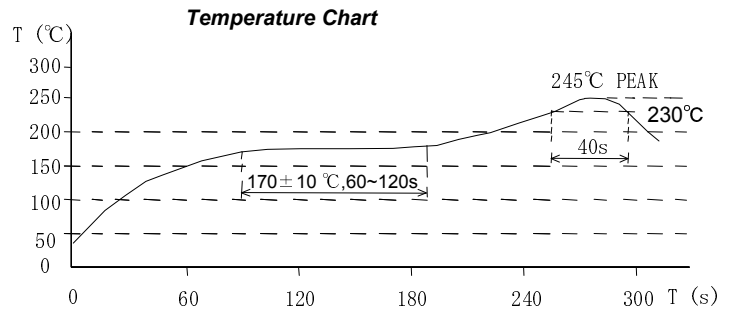
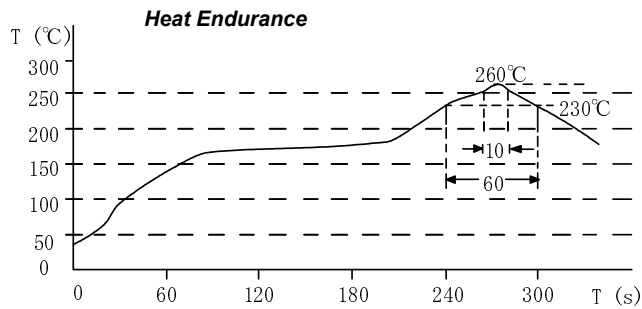

Please refer to the sales offices on our website - <http://www.sumida.com>

### Hong Kong

Tel.+852-2880-6688  
FAX.+852-2565-9600  
[sales@hk.sumida.com](mailto:sales@hk.sumida.com)

### Tokyo

Tel.+81-3-5202-7112  
FAX.+81-3-5202-7105  
[sales@jp.sumida.com](mailto:sales@jp.sumida.com)

### Chicago

Tel.+1-847-545-6700  
FAX. +1-847-545-6720  
[sales@us.sumida.com](mailto:sales@us.sumida.com)

### Shanghai

Tel.+86-021-5836-3299  
FAX.+86-021-5836-3266  
[shanghai.sales@cn.sumida.com](mailto:shanghai.sales@cn.sumida.com)

### Seoul

Tel.+82-2-6237-0777  
FAX.+82-2-6237-0778  
[sales@kr.sumida.com](mailto:sales@kr.sumida.com)

### Oberzell

Tel.+49-8591-937-0  
FAX. +49-8591-937-103  
[contact@sumida-eu.com](mailto:contact@sumida-eu.com)

### Shenzhen

Tel.+86-755-8291-0228  
FAX.+86-755-8291-0338  
[shenzhen.sales@cn.sumida.com](mailto:shenzhen.sales@cn.sumida.com)

### Singapore

Tel.+65-6296-3388  
FAX.+65-6296-3390  
[sales@sg.sumida.com](mailto:sales@sg.sumida.com)

### Neumarkt

Tel.+49-9181-4509-110  
FAX. +49-9181-4509-310  
[infocomp@eu.sumida.com](mailto:infocomp@eu.sumida.com)

### Taipei

Tel.+886-2-8751-2737  
FAX.+886-2-8751-2738  
[sales@tw.sumida.com](mailto:sales@tw.sumida.com)

### San Jose

Tel.+1-408-321-9660  
FAX.+1-408-321-9308  
[sales@us.sumida.com](mailto:sales@us.sumida.com)