

THESE DRAWINGS ARE THE PROPERTY OF QUALTEK ELECTRONICS AND NOT TO BE REPRODUCED FOR OR COMMUNICATED TO A THIRD PARTY WITHOUT THE EXPRESS WRITTEN PERMISSION OF AN OFFICER OF QUALTEK ELECTRONICS.

REVISION			
REV.	DESCRIPTION	DATE	APPROVED
B	RoHS Compliancy	06-01-06	DP
C	Updated Specifications	09-18-08	LY

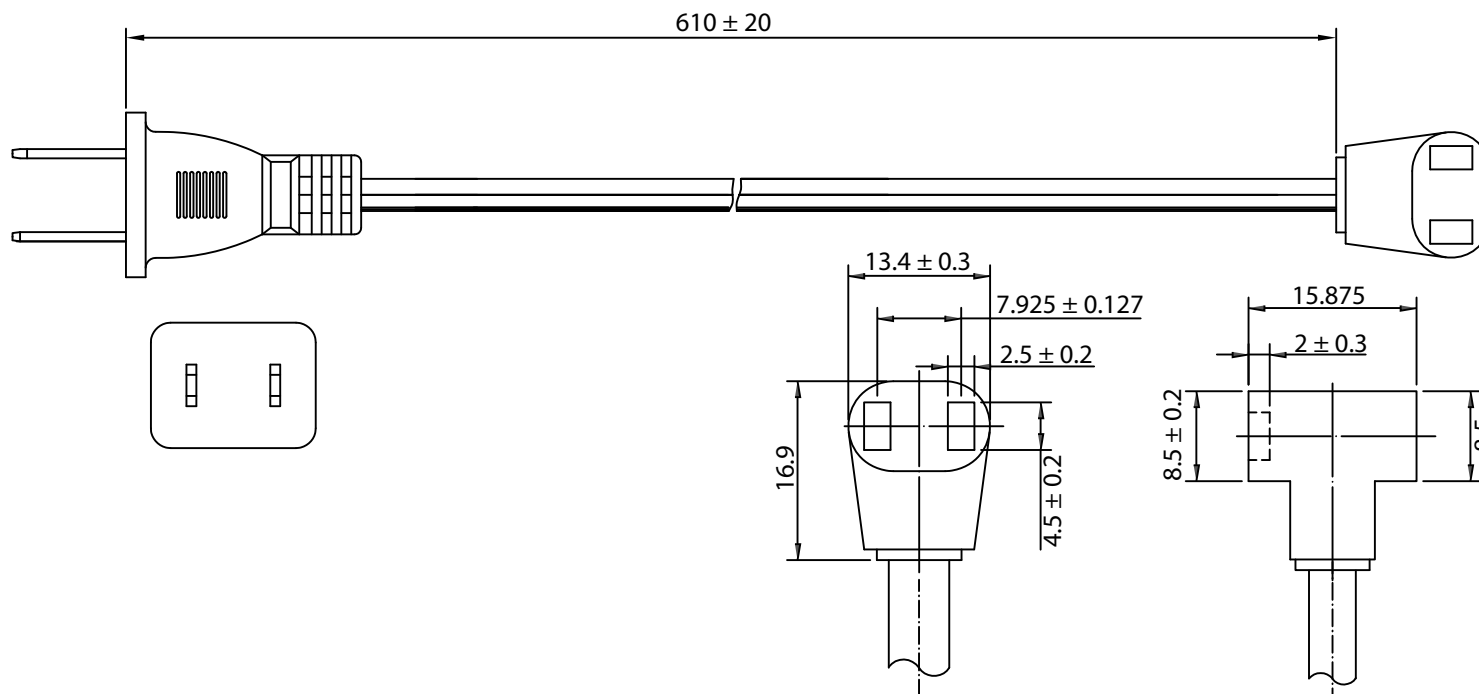

**CONTROLLED**

NOTES:

1. RATING: 10A 125V
2. PLUG: NEMA 1-15P
3. CORDAGE: SPT-1, 18AWG/2C, 105°C
4. CORD LENGTH: 610mm
5. APPROVALS: UL, cUL
6. RoHS COMPLIANT

Dim range (mm)	Tolerance +/- (mm)	Qualtek Electronics Corp. FAN-S DIVISION		
0-1	0.15	Part Number: 07199-SP024		
1-6	0.20	Description: FAN CORD FEMALE T W/ NEMA 1-15 PLUG		
6-18	0.30		UNIT: mm	REV. C
18-50	0.50	Drawn / Date	Checked / Date	Approved / Date
50-120	0.70	B.Zhang 10-18-02	10-18-02	JJH / 10-18-02
120-250	0.90			
250-500	1.20			