

CUSTOMER PRINT

PART NUMBER: 6382-XPG-5XX

**NOTES:**

1. ALL PARTS TO BE BULK PACKED.
2. CONTACTS ARE ASSEMBLED INTO THE CABLE CONNECTOR.
3. ALL DIMENSIONS ARE REFERENCE ONLY UNLESS OTHERWISE STATED.

ASSY P/N	GROMMET SIZE
6382-XPG-513	.148 GROMMET I.D. FOR CABLE O.D. .13-.15 [3.3-3.8mm]
6382-XPG-516	.176 GROMMET I.D. FOR CABLE O.D. .16-.18 [4.1-4.6mm]
6382-XPG-519	.206 GROMMET I.D. FOR CABLE O.D. .19-.21 [4.8-5.3mm]
6382-XPG-522	.245 GROMMET I.D. FOR CABLE O.D. .22-.25 [5.6-6.3mm]
6382-XPG-526	.265 GROMMET I.D. FOR CABLE O.D. .25-.27 [6.3-6.8mm]
6382-XPG-528	.280 GROMMET I.D. FOR CABLE O.D. .26-.28 [6.6-7.1mm]

KIT P/N	NO. OF CONTACTS
6382-2PG-5XX	2 #16
6382-3PG-5XX	3 #16
6382-4PG-5XX	4 #16
6382-XPG-5XX	

GROMMET SIZE

NO. OF CONTACTS

**FACE VIEW**  
6382-2PG-5XX

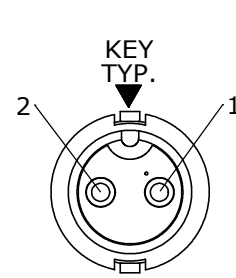

O-RING  
MAT'L: RUBBER, BLK

.040  
[1]

.086±.015  
[2.2±0.4]

.895  
[22.7]

.430  
[10.9]

1.012  
[25.7]

.190  
[4.8]

1.033  
[26.2]

**WIRE VIEW**  
6382-2PG-5XX

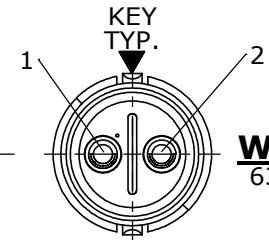

**FACE VIEW**  
6382-3PG-5XX

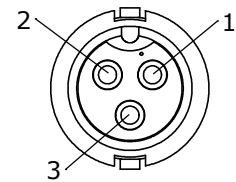

**WIRE VIEW**  
6382-3PG-5XX

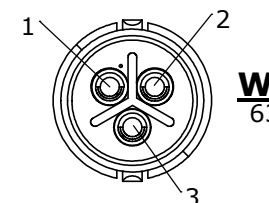

**FACE VIEW**  
6382-4PG-5XX

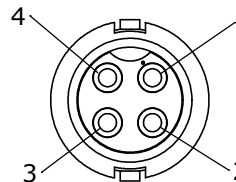

**WIRE VIEW**  
6382-4PG-5XX

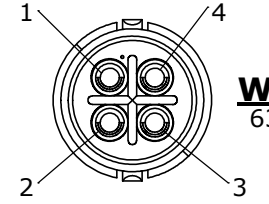

CABLE CONNECTOR, MALE  
MAT'L: NYLON, BLK

(2-4) #16 PIN CONTACTS  
SOLDER CUP  
MAT'L: GOLD PLATED, COPPER ALLOY

COUPLING RING  
MAT'L: NYLON, BLK

GROMMET  
MAT'L: RUBBER, BLK

CABLE GRIP  
MAT'L: POLYPROPYLENE, BLK

BACKSHELL  
MAT'L: NYLON, BLK

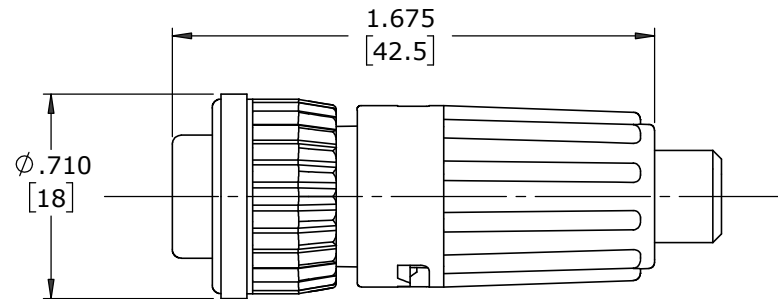

**ASSEMBLED KIT**  
FOR CUSTOMER REFERENCE ONLY

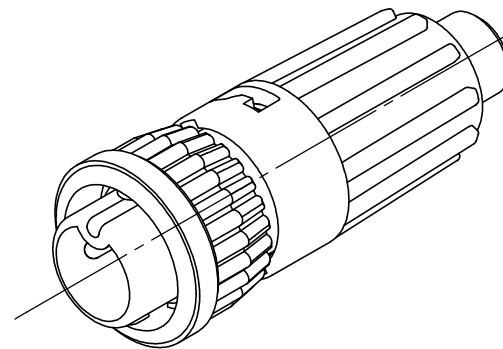

**CUSTOMER APPROVAL**

THIS DOCUMENT CONTAINS CONFIDENTIAL INFORMATION PROPRIETARY TO CONXALL CORPORATION. ANY REPRODUCTION, DISCLOSURE, OR USE OF THIS DOCUMENT /INFORMATION IS EXPRESSLY PROHIBITED UNLESS AUTHORIZED IN WRITING BY CONXALL CORPORATION.

APPROVED BY: \_\_\_\_\_  
DATE: \_\_\_\_\_

B	MA	02-12-21	UPDATED MFG DRAWING & STANDARDIZED PER ECR 9544
A	JD	09-22-17	DRAWING CREATED PER ECR 9065
REV.	INIT.	DATE	DESCRIPTION
	JD	09-22-17	ORIG. DRAWN BY: DATE: JD 09-22-17
ALL INFORMATION ILLUSTRATED IS THE PROPERTY OF "CONXALL CORPORATION". UNAUTHORIZED DUPLICATION OR DISTRIBUTION OF THIS DOCUMENT IS PROHIBITED.			<p>601 E. WILDWOOD VILLA PARK, IL 60181</p>
ALL UNITS ARE IN FEET, INCHES, FRACTION OF INCHES AND DECIMALS.			
APPROVED BY:		TITLE: CABLE CONNECTOR KIT (2-4) #16 PIN CONTACTS (SOLDER CUP) MINI-CON-X	
SCALE: NTS		CUSTOMER: STANDARD PRODUCT	
SIZE: B		SHEET: 1 OF 1	
FILE: 6382-XPG-5XX		PART NUMBER: 6382-XPG-5XX	
DIRECTORY: SLW		REV: B	

DIMENSIONS IS BRACKETS [] ARE METRIC

**RoHS COMPLIANT**

CRITICAL CHARACTERISTIC FLAG PER SPEC. XXXX