

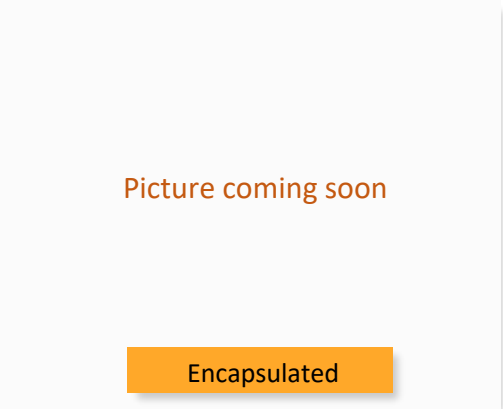

AM10BW-Z



The AM10BW-Z is a series of high performance single & dual output DC-DC converters. These converters are built in a copper package in a DIP16 miniature case and providing 4:1 wide input voltage range, stable output voltage in much smaller than standard DIP24 case.

Input voltage ranges are: 9-36VDC & 18-75VDC, output voltages are; 3.3, 5, 12, 15, 24, ± 12 , ± 15 VDC. Featuring new PWM design with no minimum load required & precise 1% output voltage accuracy.

Can be widely used in industrial control, power electronics, instrumentation, medical devices, rail transportation, communications, etc.

Features

- Wide 4:1 Input Range: 9VDC – 75VDC
- Operating Temp: -40 °C to +100 °C
- Low ripple & noise, up to 60mV(p-p) max
- Efficiency up to 87%
- Adjustable output voltage
- Output short circuit, over load protection
- Regulated Output

Summary

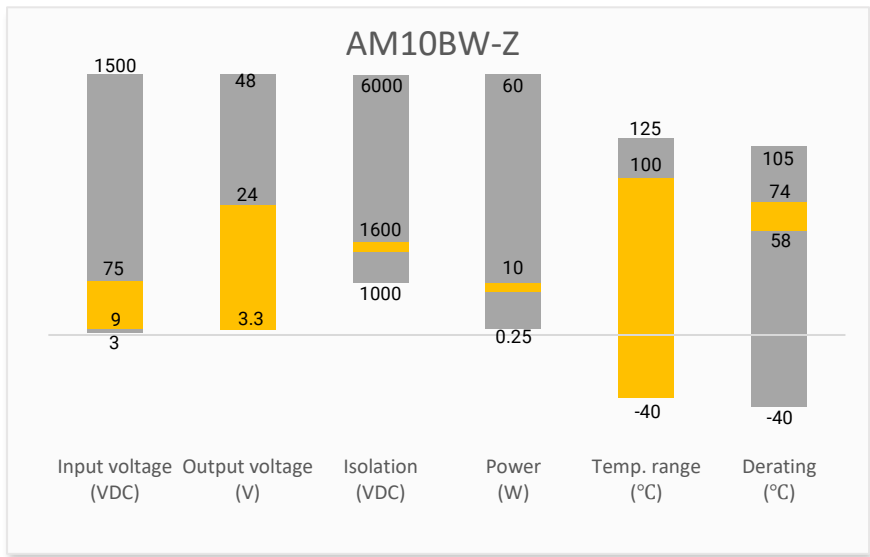

Training



Product Training Video
(click to open)



Press Release

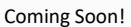

Coming Soon!

Applications



Models & Specifications

Single Output

Model	Input Voltage (VDC)	Output Voltage (VDC)	Input Current Max (mA)		Output Current Max (mA)	Maximum Capacitive Load (μ F)	Efficiency (%) Full Load
			No Load	Full Load			
AM10BRW-2403SZ	24 (9 ~ 36)	3.3	10	464	2700	3300	80
AM10BRW-2405SZ	24 (9 ~ 36)	5	10	502	2000	2200	83
AM10BRW-2412SZ	24 (9 ~ 36)	12	10	479	833	1000	87
AM10BRW-2415SZ	24 (9 ~ 36)	15	10	479	666	680	87
AM10BRW-2424SZ	24 (9 ~ 36)	24	10	479	416	330	87
AM10BRW-4803SZ	48 (18 ~ 75)	3.3	7	232	2700	3300	80
AM10BRW-4805SZ	48 (18 ~ 75)	5	7	251	2000	2200	83
AM10BRW-4812SZ	48 (18 ~ 75)	12	7	239	833	1000	87
AM10BRW-4815SZ	48 (18 ~ 75)	15	7	239	666	680	87
AM10BRW-4824SZ	48 (18 ~ 75)	24	7	239	416	330	87

Dual Output

Model	Input Voltage (VDC)	Output Voltage (VDC)	Input Current Max (mA)		Output Current Max (mA)	Maximum Capacitive Load (μ F)	Efficiency (%) Full Load
			No Load	Full Load			
AM10BRW-2412DZ	24 (9 ~ 36)	± 12	10	478	± 416	± 680	87
AM10BRW-2415DZ	24 (9 ~ 36)	± 15	10	478	± 333	± 470	87
AM10BRW-4812DZ	48 (18 ~ 75)	± 12	7	239	± 416	± 680	87
AM10BRW-4815DZ	48 (18 ~ 75)	± 15	7	239	± 333	± 470	87

Input Specification

Parameters	Conditions	Typical	Maximum	Units
Voltage range	See models table			VDC
Filter	Pi filter			
Absolute maximum rating	100ms	24VDC input models	50	VDC
		48VDC input models	100	VDC
Start up time	Nominal input & constant resistive load	20		ms
Input reflected ripple current*			20	mA pk-pk
Under voltage lock out	Nominal 24V input models	7.0	8.8	VDC
	Nominal 48V input models	16.0	17.8	

* Input reflected ripple current measured with a source inductance of 8.2uH and a source capacitor Cin (47uF,ESR<1.0 Ω at 100KHz)

Isolation Specification

Parameters	Conditions	Typical	Maximum	Units
Tested I/O voltage	60 sec	1600		VDC
Tested case to I/O voltage Resistance		1000		M Ω
Capacitance		≥ 1000	1200	

Output Specification				
Parameters	Conditions	Typical	Maximum	Units
Voltage accuracy			± 1	%
Line regulation	Full load, Single / Dual (Output voltage balance)		± 0.5	%
Load regulation	0 ~ 100% load		± 1	%
Cross regulation (Dual)	One load is 25% - 100%, the other load is 100%		± 5	%
Over load protection		160		%
Short circuit protection	Continuous, Auto recovery			
Voltage adjustment	Single output models only		± 10	%Vout
Temperature coefficient	Full load		± 0.02	%/°C
Ripple & Noise*	20MHz bandwidth	Output 3.3VDC / 5VDC	60	mV pk-pk
		Others	80	
Transient recovery time	25% load step change	250		µS
Transient response deviation	25% load step change	Output 3.3VDC / 5VDC	±5	%
		Others	±3	

* Ripple and Noise are measured at 20MHz bandwidth by using a 1µF (M/C) and 10µF (E/C) parallel capacitor and typical input with full load

General Specifications				
Parameters	Conditions	Typical	Maximum	Units
Switching frequency	100% load	370		KHz
Operating temperature	See derating graph	-40 to +85		°C
Storage temperature		-55 to +125		°C
Maximum case temperature			105	°C
Soldering temperature	1.5mm from case 10 sec max		260	°C
Cooling	Nature Convection (30~65 LFM)			
Humidity	Non-condensing		95	% RH
Case material	Copper			
Base material	Non-Conductive Black Plastic (UL94V-0)			
Potting material	Epoxy (UL94V-0)			
Pin material	Φ0.5mm brass solder-coated			
Weight	10			g
Dimensions (L x W x H)	0.94 x 0.54 x 0.41 inches, 23.80 x 13.70 x 10.40mm			
MTBF	> 485 000 hrs (MIL-HDBK -217F, t _a +25°C) / Full Load			

Safety Specifications		
Parameters		
Standards	Designed to meet UL/IEC/EN 60950-1,62368-1	
	EMC - Conducted and radiated emission	EN55032, CLASS A
	Electrostatic Discharge Immunity	IEC 61000-4-2 , Criteria A
	RF, Electromagnetic Field Immunity	IEC 61000-4-3 , Criteria A
	Electrical Fast Transient/Burst Immunity	IEC 61000-4-4 , Criteria A with recommended circuit
	Surge Immunity	IEC 61000-4-5 , Criteria A with recommended circuit
	RF, Conducted Disturbance Immunity	IEC 61000-4-6 , Criteria A
	PFMF	IEC 61000-4-8 , Criteria A

Derating



Nature Convection

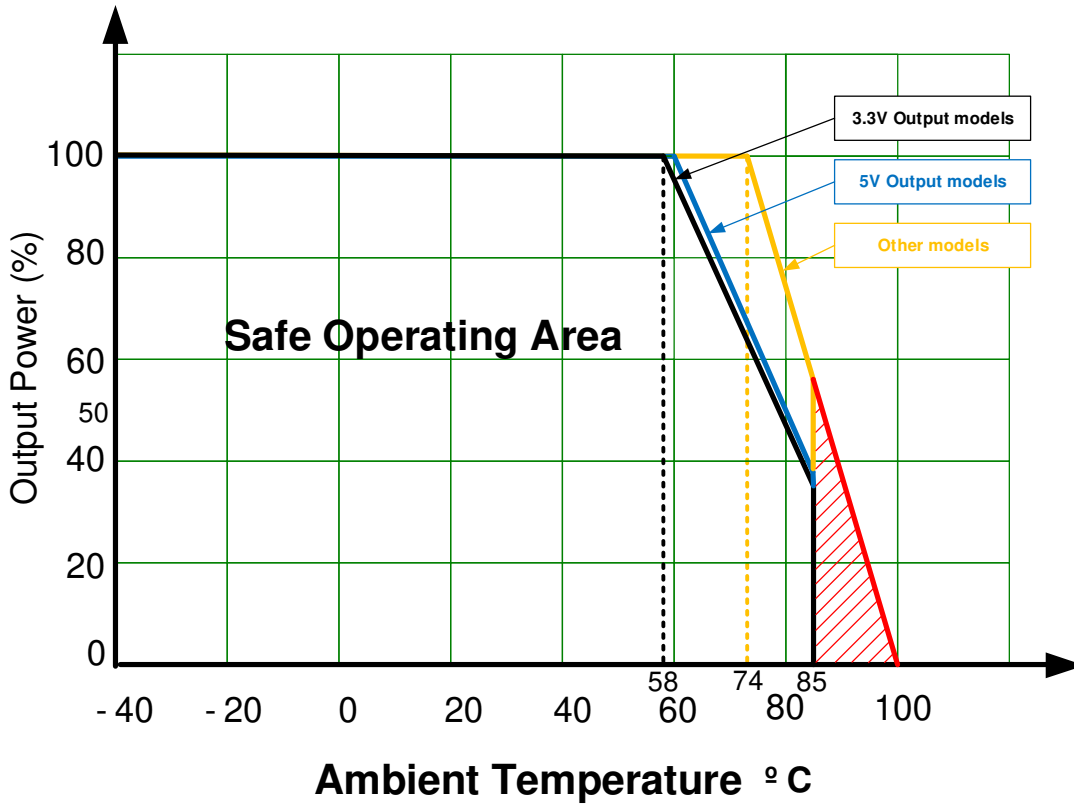

Input Reflected Ripple Current

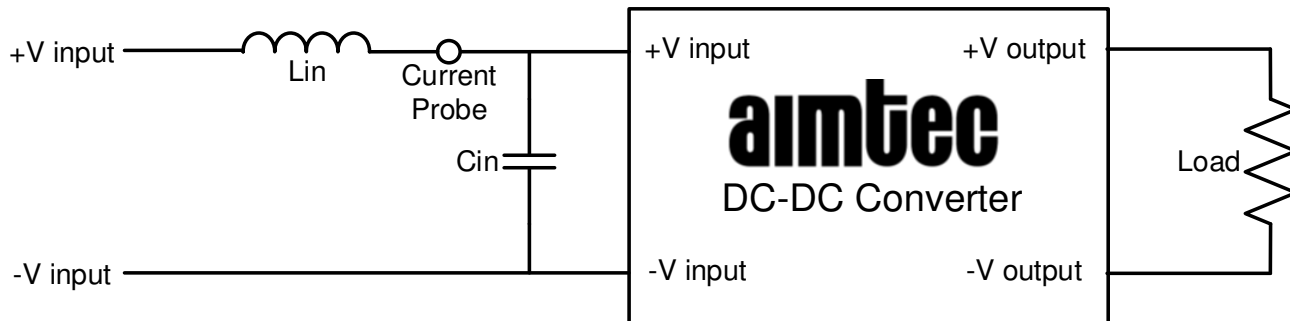

Lin : 8.2uH / Cin : 47uF,ESR<1.0Ω at 100KHz

EFT & Surge Recommended Circuit

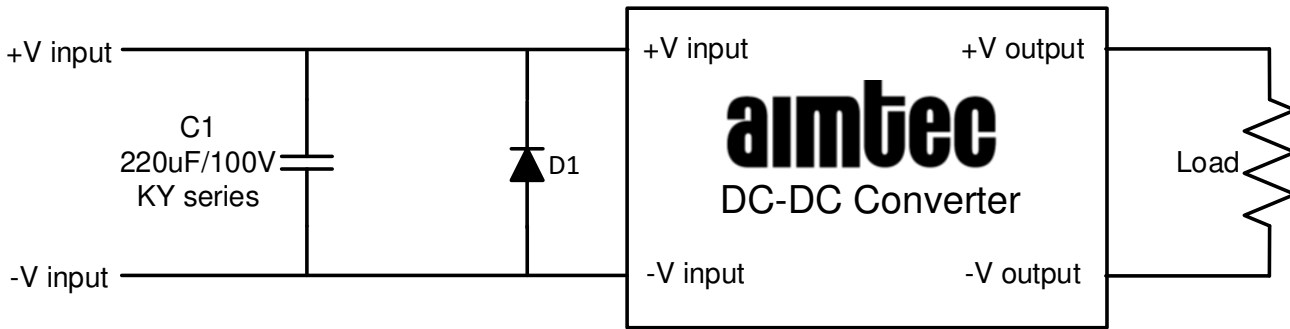

	D1
AM10BW-24XX	TVS, 58V, 3KV
AM10BW-48XX	TVS, 120V, 3KV

Output voltage adjustment



Single output models only

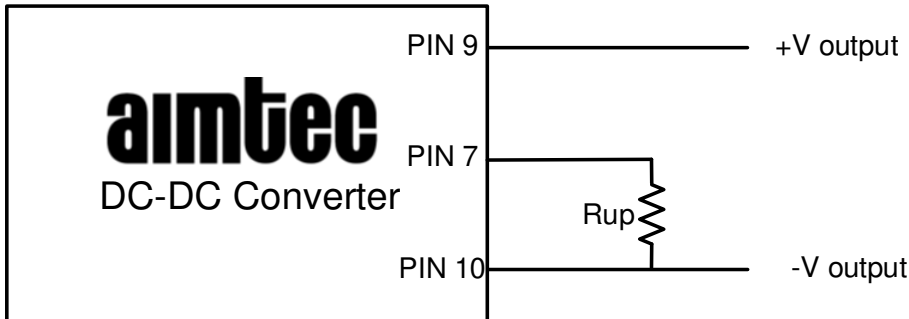

Pin 7 via a resistor to Pin 10(-Vout), Vo trim up.

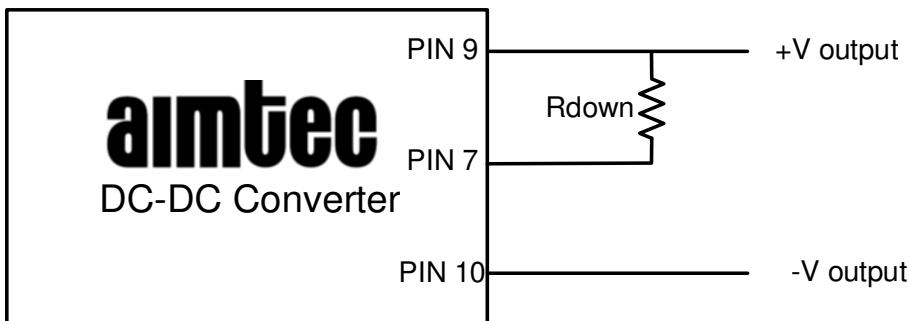

Pin 7 via a resistor to Pin 9(+Vout), Vo trim down.

Dimensions

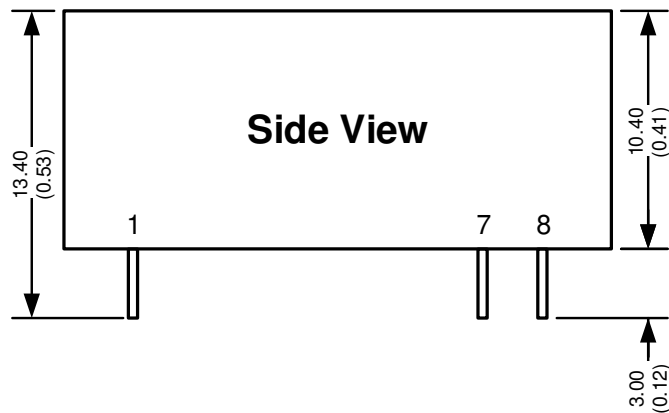
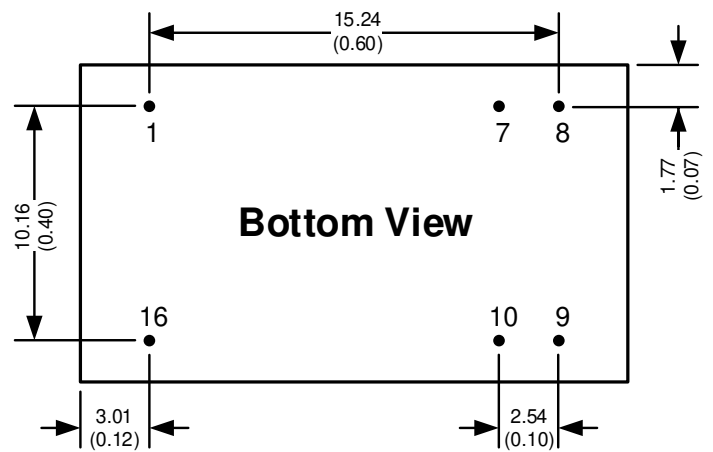
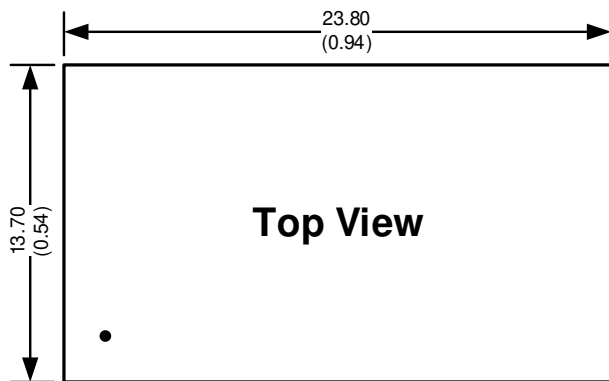

Notes:

All dimensions are typical in millimeters (inches).

Pin diameter : 0.5 ± 0.05 (0.02 ± 0.002)

Pin pitch and length tolerance ± 0.35 (± 0.014)

Stand-off tolerance ± 0.50 (± 0.02)

Pin Out Specifications

Pin	Single	Dual
1	-V Input	-V Input
7	Trim	NC
8	NC	Common
9	+V Output	+V Output
10	-V Output	-V Output
16	+V Input	+V Input

NOTE: **1.** Datasheets are updated as needed and as such, specifications are subject to change without notice. Once printed or downloaded, datasheets are no longer controlled by Aimtec; refer to www.aimtec.com for the most current product specifications. **2.** Product labels shown, including safety agency certifications on labels, may vary based on the date manufactured. **3.** Mechanical drawings and specifications are for reference only. **4.** All specifications are measured at an ambient temperature of 25°C, humidity < 75%, nominal input voltage and at rated output load unless otherwise specified. **5.** Aimtec may not have conducted destructive testing or chemical analysis on all internal components and chemicals at the time of publishing this document. CAS numbers and other limited information are considered proprietary and may not be available for release. **6.** This product is not designed for use in critical life support systems, equipment used in hazardous environments, nuclear control systems or other such applications which necessitate specific safety and regulatory standards other than the ones listed in this datasheet. **7.** Warranty is in accordance with Aimtec's standard Terms of Sale available at www.aimtec.com.