

50-Ampere N-P-N Darlington Power Transistors

Features:

- High speed $t_s < 5.0 \mu\text{sec.}$, $t_r < 3.0 \mu\text{sec.}$
- High voltage: 400-500 V_{CEO}
- High gain: h_{FE} 50 minimum @ 50 amperes, I_C
- High current: 75 amperes, I_C (Peak)

The D64DV and D64EV series of silicon n-p-n power Darlington transistors are designed for use in high-speed switching applications. These applications include off-line switching power supplies, PWM ac and dc motor controls, UPS systems, ultrasonic equipment, and other high-frequency power conversion equipment.

These devices are supplied in the JEDEC TO-204AE hermetic steel package.

TERMINAL DESIGNATIONS

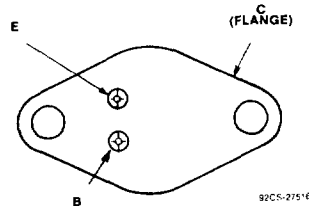

JEDEC TO-204AE

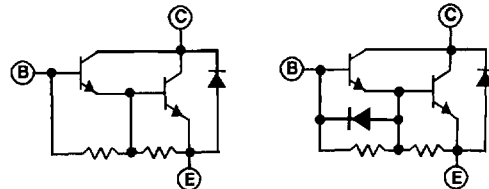

D64DV

D64EV

DEVICE CIRCUIT

MAXIMUM RATINGS ($T_A = 25^\circ\text{C}$) (unless otherwise specified)

RATING	SYMBOL	D64DV5/EV5	D64DV6/EV6	D64DV7/EV7	UNITS
Collector-Emitter Voltage	V_{CEO}	400	450	500	Volts
Collector-Base Voltage	V_{CBO}	500	600	700	Volts
Emitter Base Voltage	V_{EBO}	8	8	8	Volts
		5	5	5	
Collector Current — Continuous	I_C	50	50	50	A
Peak (Repetitive)	I_{CM}	75	75	75	
Peak (Non-Repetitive)	I_{CSM}	125	125	125	
Base Current — Continuous	I_B	10	10	10	A
Peak (Non-Repetitive)	I_{BM}	20	20	20	
Total Power Dissipation @ $T_C = 25^\circ\text{C}$	P_D	180	180	180	Watts
Operating and Storage Junction Temperature Range	T_J, T_{STG}	-65 to +150	-65 to +150	-65 to +150	$^\circ\text{C}$

THERMAL CHARACTERISTICS

Characteristic	Symbol	D64DV5/EV5	D64DV6/EV6	D64DV7/EV7	UNITS
Thermal Resistance, Junction to Case	$R_{\theta JC}$	0.7	0.7	0.7	$^\circ\text{C/W}$
Maximum Lead Temperature for Soldering Purposes: 1/8" from Case for 5 Seconds	T_L	300	300	300	$^\circ\text{C}$

2
POWER TRANSISTORS

D64DV5,6,7 D64EV5,6,7

ELECTRICAL CHARACTERISTICS ($T_C = 25^\circ\text{C}$) (unless otherwise specified)

CHARACTERISTIC	SYMBOL	MIN	TYP	MAX	UNIT
----------------	--------	-----	-----	-----	------

OFF CHARACTERISTICS

Collector-Emitter Sustaining Voltage ($I_C = 0.5\text{A}$) ($V_{\text{clamp}} = V_{\text{CEO Rated}}$)	D64DV5/EV5 D64DV6/EV6 D64DV6/EV7	$V_{\text{CEO(sus)}}$	400 450 500	— — —	— — —	Volts
Collector Cutoff Current ($V_{\text{CE}} = \text{Rated Value}$, $V_{\text{BE}} = -1.5\text{V}$)	$T_J = 25^\circ\text{C}$ $T_J = 150^\circ\text{C}$	I_{CEV}	— —	— —	1.0 2.5	mA
Emitter Cutoff Current ($V_{\text{EB}} = 4.5\text{V}$, $I_C = 0$) ($V_{\text{EB}} = 1.5\text{V}$, $I_C = 0$)	D64DV D64EV	I_{EBO}	— —	— —	350 350	mA

SECOND BREAKDOWN

Second Breakdown with Base Forward Biased	FBSOA	SEE FIGURE 23
---	-------	---------------

ON CHARACTERISTICS

DC Current Gain ($I_C = 75\text{A}$, $V_{\text{CE}} = 5\text{V}$) ($I_C = 50\text{A}$, $V_{\text{CE}} = 5\text{V}$) ($I_C = 20\text{A}$, $V_{\text{CE}} = 5\text{V}$)	h_{FE}	25 50 100	60 135 250	— — —	—
Collector-Emitter Saturation Voltage ($I_C = 75\text{A}$, $I_B = 5\text{A}$) ($I_C = 50\text{A}$, $I_B = 4\text{A}$) ($I_C = 20\text{A}$, $I_B = 2\text{A}$)	$V_{\text{CE(sat)}}$	— — —	2.2 1.7 1.15	3.0 2.0 1.5	V
Base-Emitter Saturation Voltage ($I_C = 75\text{A}$, $I_B = 5\text{A}$) ($I_C = 50\text{A}$, $I_B = 4\text{A}$) ($I_C = 20\text{A}$, $I_B = 2\text{A}$)	$V_{\text{BE(sat)}}$	— — —	2.8 2.45 1.95	3.5 3.0 2.5	V

SWITCHING CHARACTERISTICS

		TYP.		MAX.				
Resistive Load				DV	EV	DV	EV	μs
Delay Time	$V_{\text{CC}} = 250\text{V}$	t_d	—	0.09	0.09	0.5	0.5	
Rise Time		t_r	—	0.5	0.5	1	1	
Storage Time	$I_{\text{B1}} = 2.5\text{A}$, $I_{\text{B2}} = -5\text{A}$	t_s	—	2.55	2	5	3	
Fall Time		t_f	—	1.4	0.64	3	1	

EMITTER-COLLECTOR DIODE CHARACTERISTICS

Power Dissipation		P_D	—	—	125	Watts
Forward Voltage ($I_F = 25\text{A}$) ($I_P = 50\text{A}$) ($I_F = 50\text{A}$, $T_J = 150^\circ\text{C}$)		V_F	—	1.95	3.20	Volts
		V_F	—	2.60	3.80	Volts
		V_F	—	2.30	3.50	Volts
Reverse Recovery Time ($I_F = 50\text{A}$, $di/dt = 25\text{A}/\mu\text{sec}$, $R_{\text{B1E}} = 0.25\Omega$)		T_{rr}	—	3.85	10.0	μsec
Forward Turn-On Time ($I_F = 100\text{A}$, $di/dt = 100\text{A}/\mu\text{sec}$)		T_{ON}	—	0.75	1.5	μsec
Single Cycle Surge Current (60Hz)		I_{FSM}	—	—	150	Amps
Thermal Resistance		$R_{\theta\text{JC}}$	—	—	1.0	$^\circ\text{C}/\text{Watt}$

TYPICAL CHARACTERISTICS

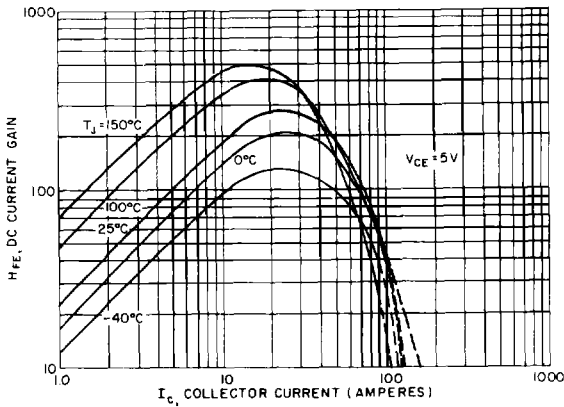

FIGURE 1. DC CURRENT GAIN ($V_{CE} = 5V$)

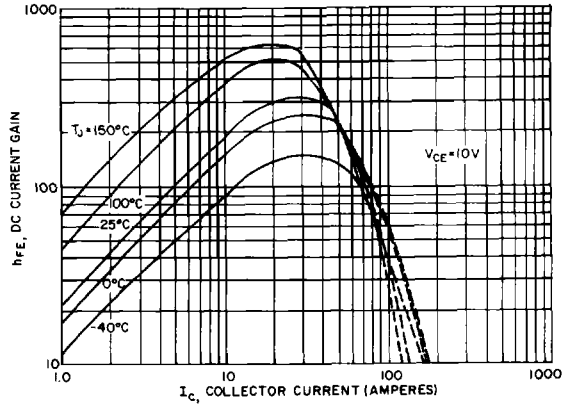

FIGURE 2. DC CURRENT GAIN ($V_{CE} = 10V$)

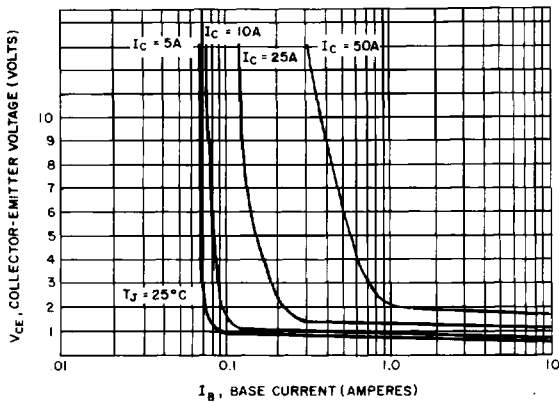

FIGURE 3. COLLECTOR SATURATION REGION

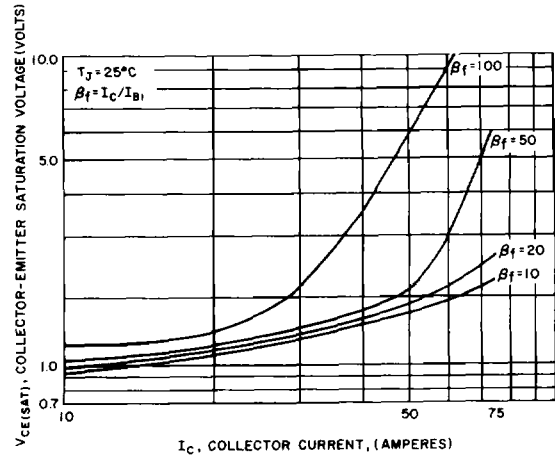

FIGURE 4. $V_{CE} (SAT)$ VS I_C , $T_J = 25^\circ C$

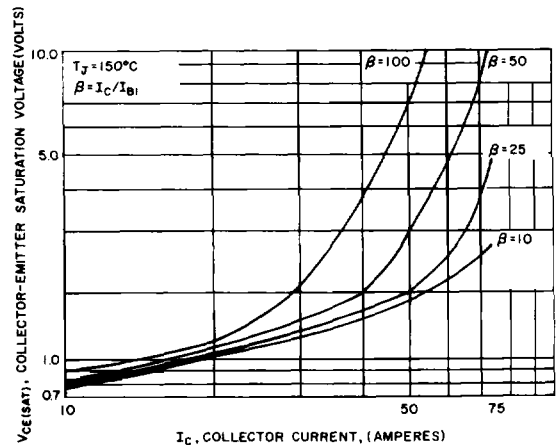

FIGURE 5. $V_{CE} (SAT)$ VS I_C , $T_J = 150^\circ C$

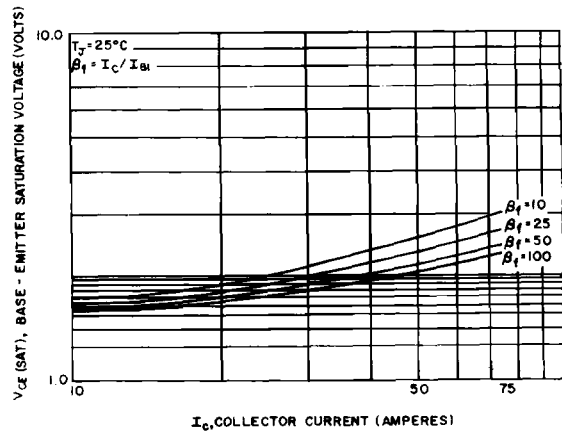

FIGURE 6. $V_{BE} (SAT)$ VS I_C , $T_J = 25^\circ C$

2
POWER TRANSISTORS

D64DV5,6,7
D64EV5,6,7

TYPICAL CHARACTERISTICS

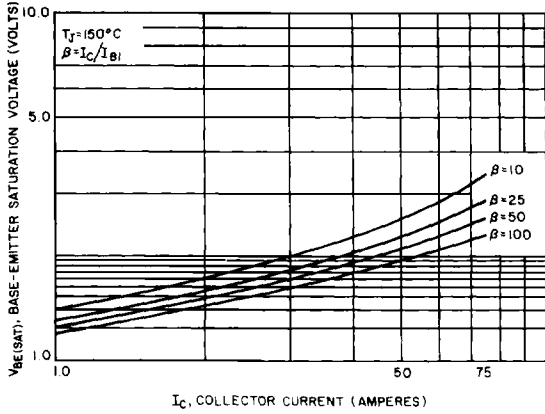

FIGURE 7. $V_{BE(SAT)}$ VS I_C , $T_J = 150^\circ\text{C}$

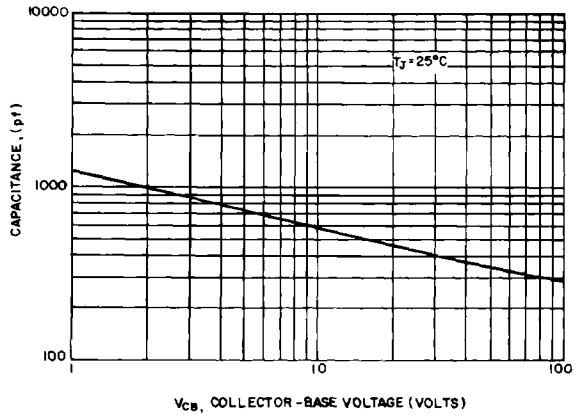

FIGURE 8. CAPACITANCE (C_{CB})

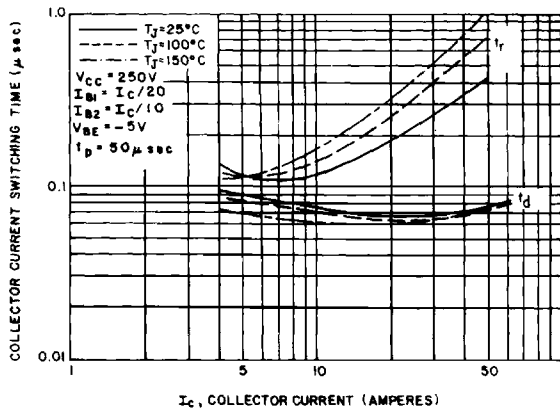

FIGURE 9. TURN-ON TIME (RESISTIVE LOAD) (D64DV ONLY)

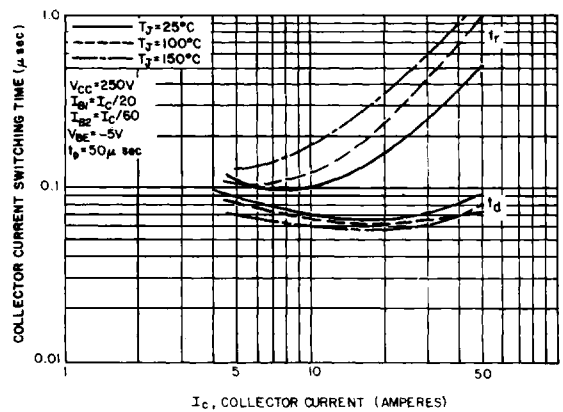

FIGURE 10. TURN-ON TIME (RESISTIVE LOAD) (D64EV ONLY)

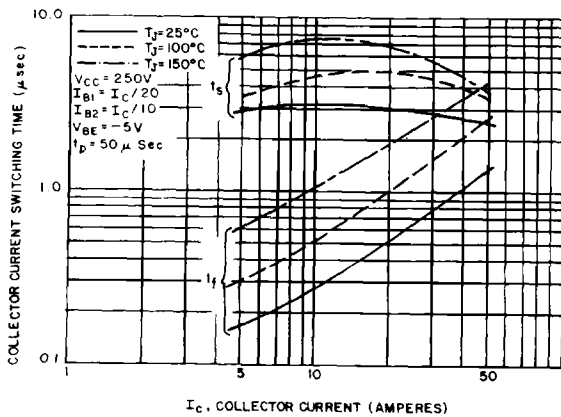

FIGURE 11. TURN-OFF TIME (RESISTIVE LOAD) (D64DV ONLY)

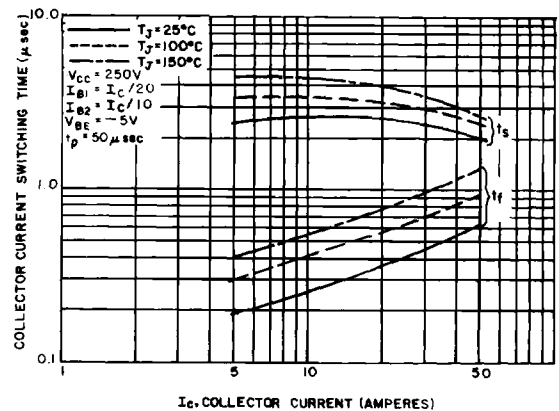

FIGURE 12. TURN-OFF TIME (RESISTIVE LOAD) (D64EV ONLY)

TYPICAL CHARACTERISTICS

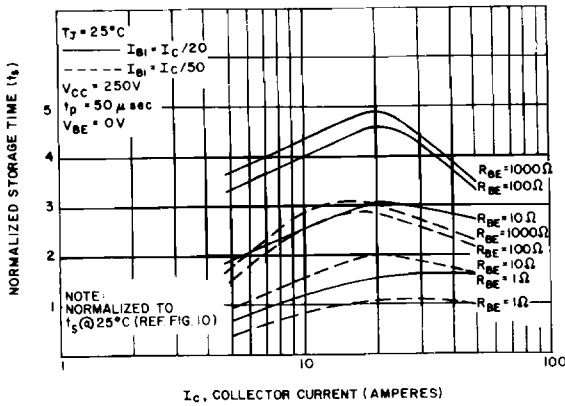

FIGURE 13. NORMALIZED RESISTIVE SWITCHING STORAGE TIME (R_{BE} VARIATIONS) VS COLLECTOR CURRENT (D64DV ONLY)

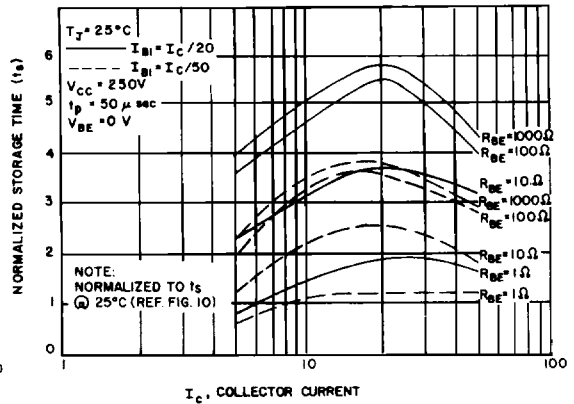

FIGURE 14. NORMALIZED RESISTIVE SWITCHING STORAGE TIME (R_{BE} VARIATIONS) VS COLLECTOR CURRENT (D64EV ONLY)

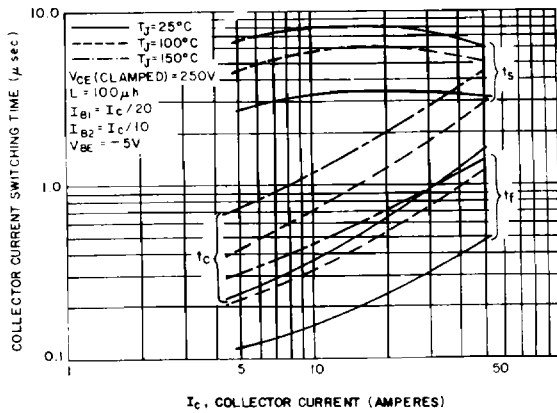

FIGURE 15. CLAMPING INDUCTIVE TURN-OFF TIME (D64DV ONLY)

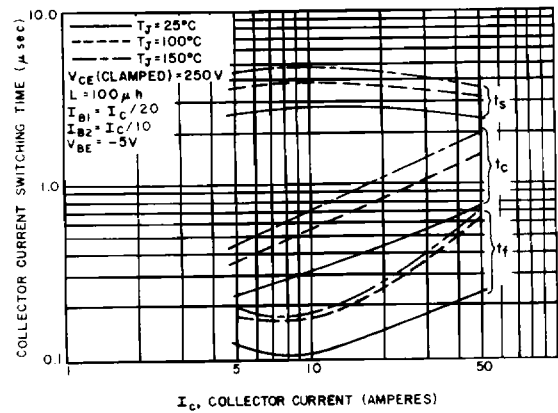

FIGURE 16. CLAMPING INDUCTIVE TURN-OFF TIME (D64EV ONLY)

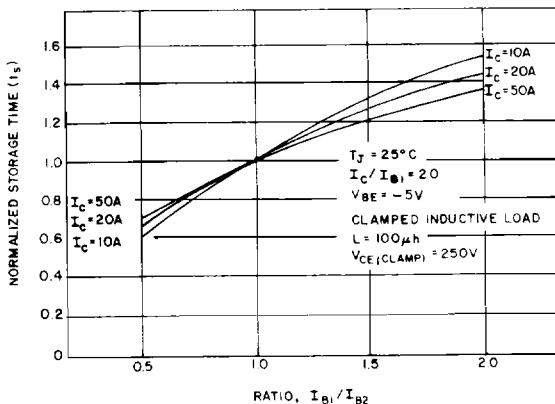

FIGURE 17. STORAGE TIME VARIATION WITH I_{B2} (D64DV ONLY)

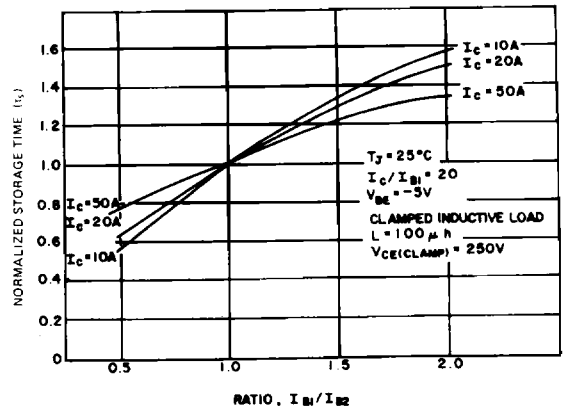

FIGURE 18. STORAGE TIME VARIATION WITH I_{B2} (D64EV ONLY)

2
POWER TRANSISTORS

D64DV5,6,7
D64EV5,6,7

TYPICAL CHARACTERISTICS

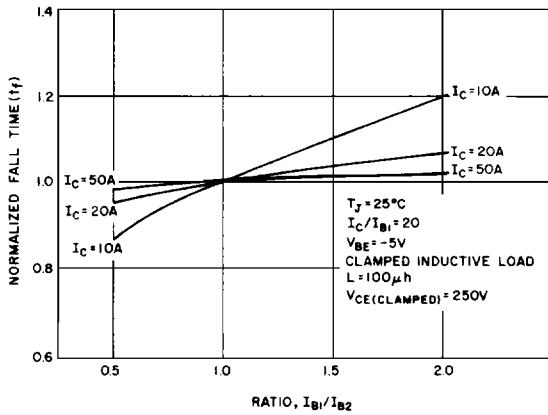

FIGURE 19. FALL TIME VARIATION WITH I_{B2} (D64DV ONLY)

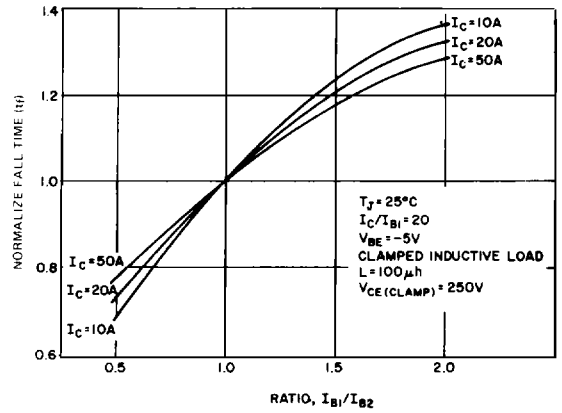

FIGURE 20. FALL TIME VARIATION WITH I_{B2} (D64EV ONLY)

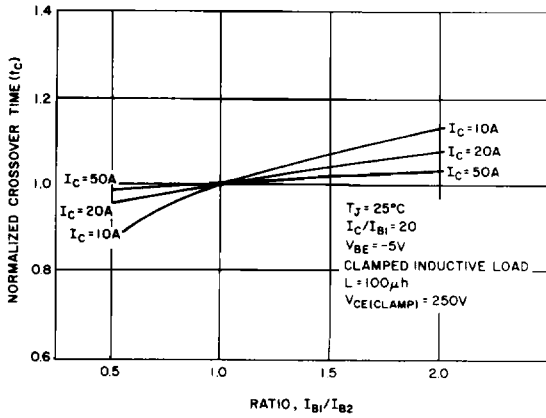

FIGURE 21. CROSSOVER TIME VARIATION WITH I_{B2} (D64DV ONLY)

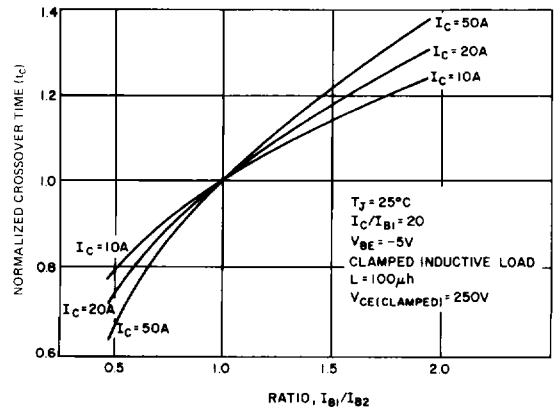

FIGURE 22. CROSSOVER TIME VARIATION WITH I_{B2} (D64EV ONLY)

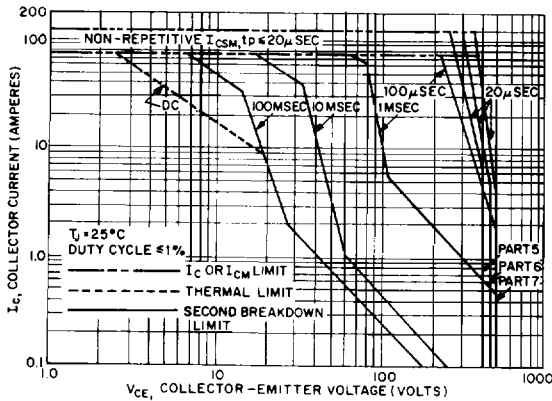

FIGURE 23. FORWARD BIAS SAFE OPERATING AREA

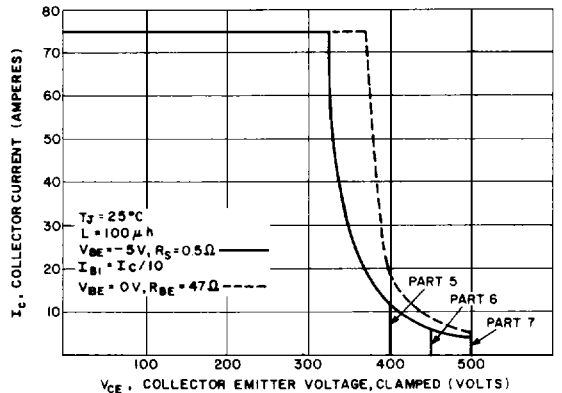

FIGURE 24. REVERSE BIAS SAFE OPERATING AREA (CLAMPED)

TYPICAL CHARACTERISTICS

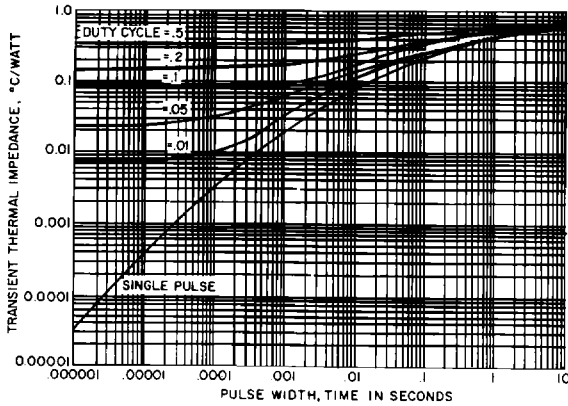

FIGURE 25. TRANSIENT THERMAL RESPONSE

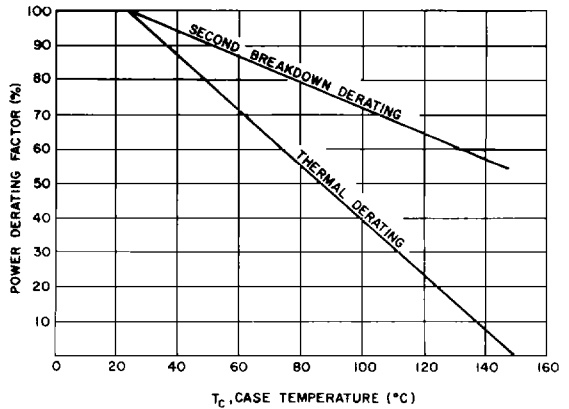

FIGURE 26. POWER DERATING

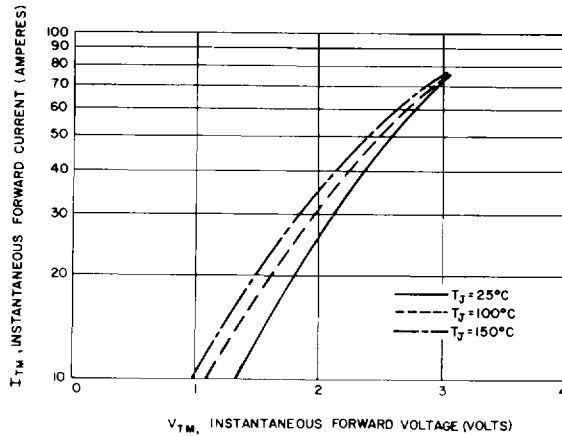

FIGURE 27. FORWARD CHARACTERISTICS

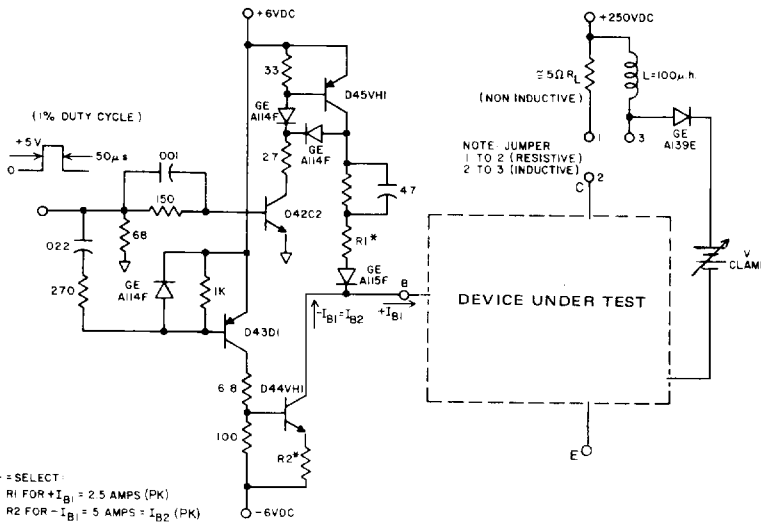

FIGURE 28. SWITCHING TIME TEST CIRCUIT