

SAID-M8S-3-SMT

Weidmüller Interface GmbH & Co. KG

Klingenbergstraße 16

D-32758 Detmold

Germany

Fon: +49 5231 14-0

Fax: +49 5231 14-292083

www.weidmueller.com

Similar to illustration



Weidmüller is now one of the industry's leading international providers of connectors. An important mainstay in this product family are the circular connectors, which Weidmüller groups under the product name SAI. In the development of SAI products, Weidmüller engineers have always concentrated on achieving rational, cost-effective installation concepts, and – in cooperation with major users – have supplied the markets with well-conceived products which set standards in terms of functionality and quality across the globe. The best examples are the new power distributors with S and T coded M12. These modules are characterised by particularly high currents and voltages. This enables them to also be used, for example, with three-phase motors.

General ordering data

Type	SAID-M8S-3-SMT
Order No.	2421750000
Version	Built-in plugs, M8, Pin, No. of poles: 3
GTIN (EAN)	4050118429718
Qty.	25 pc(s).

SAID-M8S-3-SMT**Weidmüller Interface GmbH & Co. KG**

Klingenbergstraße 16

D-32758 Detmold

Germany

Fon: +49 5231 14-0

Fax: +49 5231 14-292083

www.weidmueller.com

Technical data**Dimensions and weights**

Net weight 2.8 g

Environmental Product Compliance

REACH SVHC Lead 7439-92-1

Technical data of PCB plug-in connector

Coding	M8 = none	Housings	M8 pin
No. of poles	3	Shield connection	No
Rated voltage	60 V	Rated voltage (text)	60 V (3-pole) / 30 V (4-, 5- and 8-pole)
Rated current	4 A	Rated current	4 A (3-, 4- and 5-pole) / 1.5 A (8-pole)
Temperature range	-25...95 °C	Protection degree	IP67
Contact surface	Au (Gold)	Housing main material	LCP
Connection thread	M8	Tightening torque	M8: 0.5 Nm
Insulation strength	100 MΩ	Pollution severity	3 (2 within the sealed area)
Plugging cycles	≥ 100	Contact material	CuZn
Lock nut material	Nickel-plated CuZn	Material of the flange-mounted housing	Nickel-plated CuZn

Material data

Contact material CuZn Contact surface Au (Gold)

System parameters

Insulation strength	100 MΩ	No. of poles	3
Pin series quantity	1	Plugging cycles	≥ 100
Protection degree	IP67		

Classifications

ETIM 6.0	EC000438	eClass 6.2	27-26-07-02
eClass 9.1	27-44-02-05		

Approvals

ROHS Conform

DownloadsBrochure/Catalogue [FL FIELDWIRING EN](#)

SAID-M8S-3-SMT

Weidmüller Interface GmbH & Co. KG
 Klingenbergstraße 16
 D-32758 Detmold
 Germany
 Fon: +49 5231 14-0
 Fax: +49 5231 14-292083
 www.weidmueller.com

Drawings

Dimensioned drawing

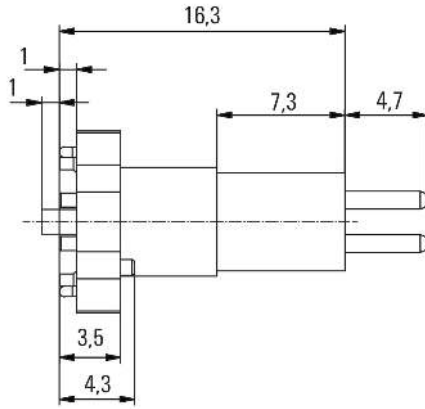

PCB design

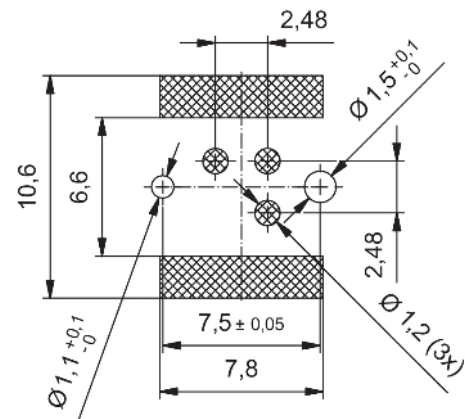

Pole scheme

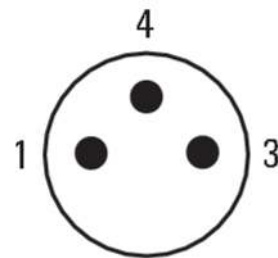

M8 = none