

# Assembly Instructions for - 38824

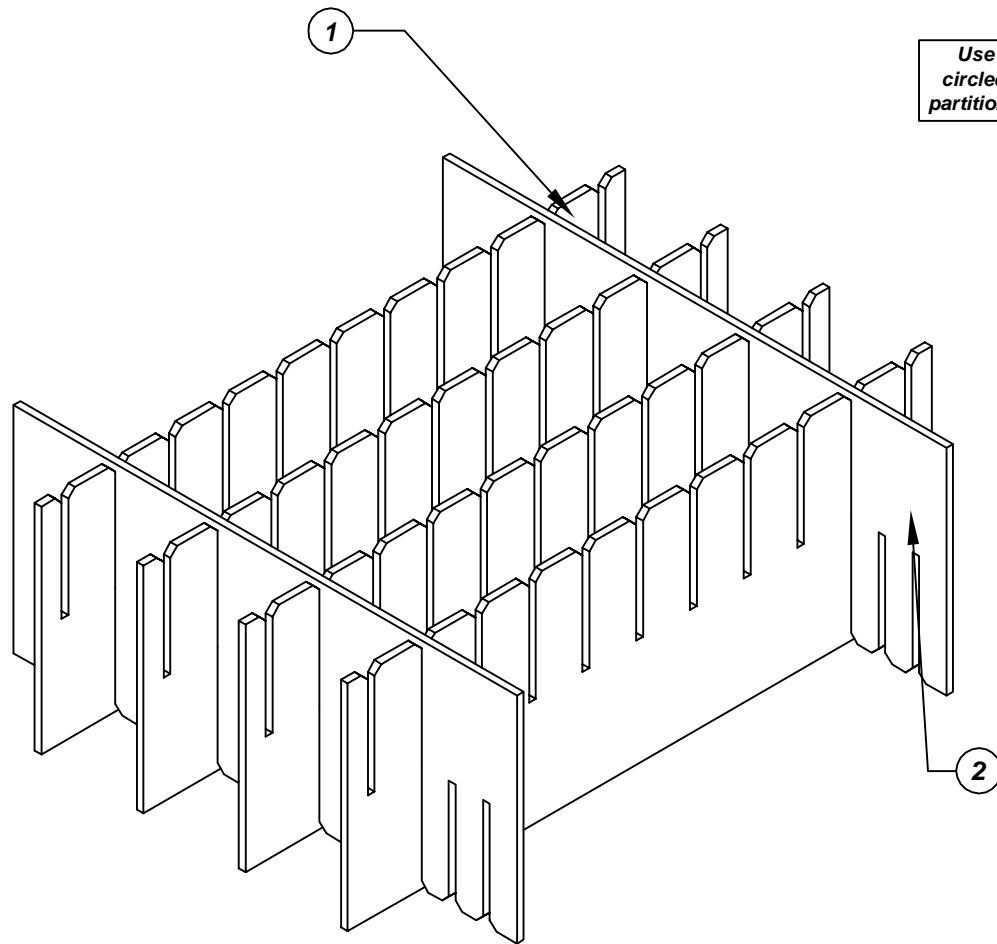

Use only the circled slots for partition assembly

Folded Short Partition

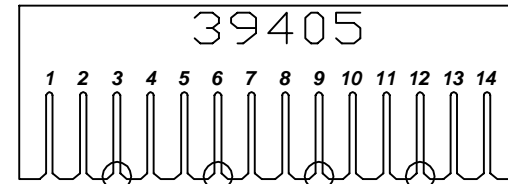

2

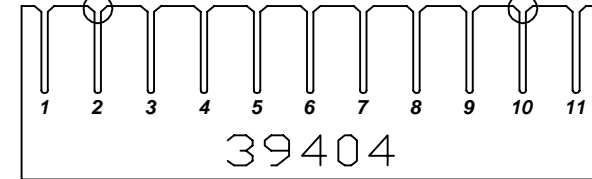

1

Folded Long Partition

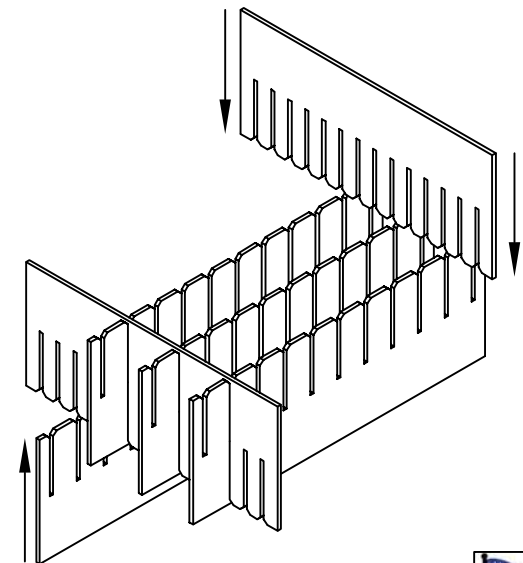

Made in America

F/N 1	Part # 39404	Dimensions: 16-3/16" x 21-3/4"	Description: Adjustable Long Partition	Qty: 4
F/N 2	Part # 39405	Dimensions: 16-3/16" x 18-3/4"	Description: Adjustable Short Partition	Qty: 2

## 38824 - 5 Cell Inplant Handler Cell Size - 8" x 15-3/4" x 3-1/2"

Notes:  
For use with the following storage container & lid:  
37532 - Storage Container  
37557 - Lid

PROTEKTIVE PAK  
13520 MONTE VISTA AVENUE, CHINO, CA 91710  
PHONE (909) 627-2578, FAX (909) 363-7331  
ProtectivePak.com



DRAWING NUMBER  
**IPH-38824**

DATE  
Dec.  
2007