

Flat suction pad (round)

SUF 60 HT1-60 G1/4-AG

Part no...:10.01.01.14077

<https://www.schmalz.com/10.01.01.14077>

Home > Vacuum Technology for Automation > Vacuum Components > Vacuum Suction Cups > Flat Suction Cups (Round) > Flat Suction Cups SUF > SUF 60 HT1-60 G1/4-AG

Flat suction cup (round) for process safe handling of smooth or slightly rough surfaces



Size: 60

Suction cup material: High temp material HT1

Material hardness [Shore A]: 60 Shore A

Vacuum connection: G1/4"-M

Design Data

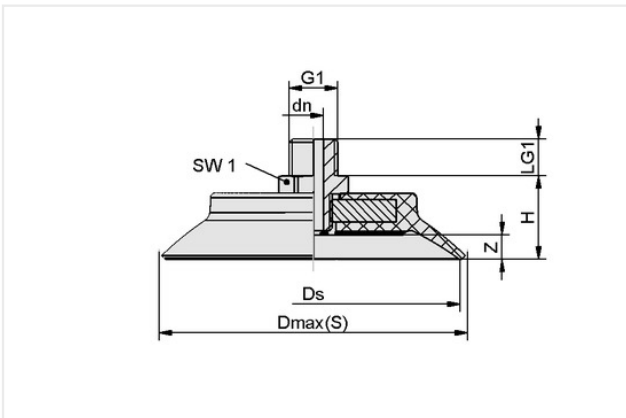

Attribute	Value
Dmax(S)	66.40 mm
Ds	60 mm
dn	5.10 mm
G1	G1/4"-M
H	22 mm
LG1	10 mm
SW1	17 mm
Z (Stroke)	5.50 mm

Technical Data

Attribute	Value
Suction force (-600mbar)	140 N
Pull-off force	140 N
Volume	12.70 cm ³
Curve radius (min) (convex)	75 mm
Hose diameter (empf.) d	6 mm
Size	60
Suction cup material	High temp material HT1
Material hardness [Shore A]	60 Shore A

Contact Schmalz

Schmalz Inc. | 5850 Oak Forest Drive, Raleigh, NC 27616, United States | +1 (919) 713-0880 | schmalz.us@schmalz.com



Flat suction pad (round)

SUF 60 HT1-60 G1/4-AG

Part no...:10.01.01.14077

<https://www.schmalz.com/10.01.01.14077>

Weight	38.60 g
Product family	SUF
Number of folds	0

Note: Suction force: The specified suction forces are theoretical values at a vacuum of -0.6 bar and with a dry, smooth and flat workpiece surface - they do not include a safety factor
Hose diameter: The recommended hose diameter refers to a hose length of approx. 2 m
