

## General information

Part number	S21M07-P07MFG0-397S
Termination	solder
Size	1
Locking principle	push
Coding	0 key
Cable Diameter	cable medi 39
Cable outlet	bend relief

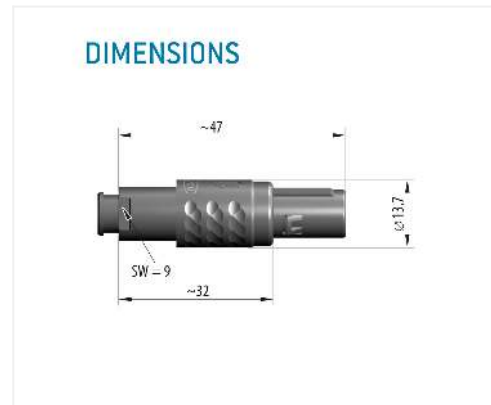
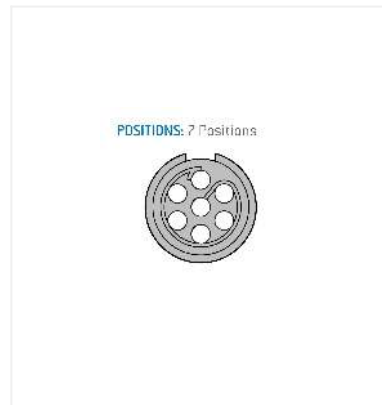

## Contact insert description

Number of contacts	7
Contact type	pins
Contact diameter	07mm
Insulator material	peek
Wire cross section	22_awg
Termination	solder
Termination diameter	085mm

reverse\_gender\_on\_request

## Technical information

Max. creepage and air clearance distance	065 mm	
Nominal current single contact	075_a	iec_60512_5_2
Nominal current insert	4,875 A	vde_0298_4
Test voltage	135_kv_dc	sae_13441

safety\_text

## Mechanical and environmental data

Degree of protection*	ip50
Operating temperature	50_120_c
Mating cycles	2000

mated\_unmated

## Insulator materials MEDI-SNAP®

psu\_peek

## Material and surface treatments

<b>Housing</b>	psu_gray
<b>Color option</b>	gray
<b>Contact</b>	cu_alloy_gold

safety\_text\_2  
ul\_text  
illustrative\_text