

5

4

3

2

1

Hood upper part

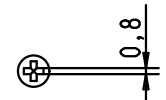
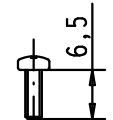
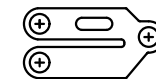
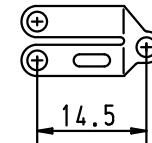
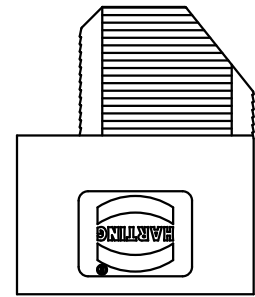
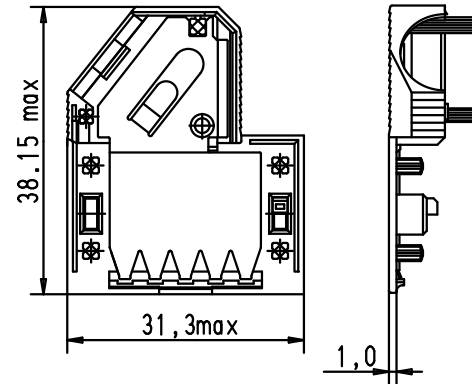
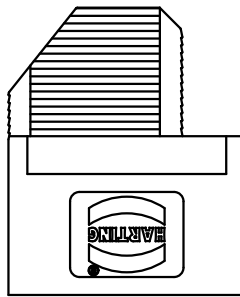
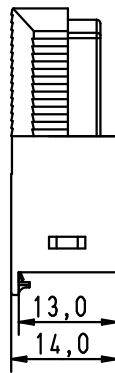
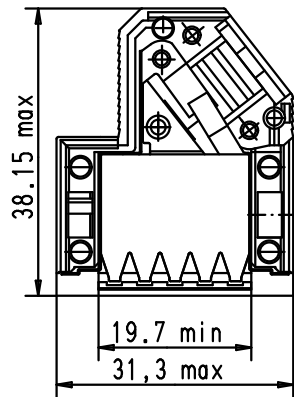

Hood lower part



Strain relief 1

Strain relief 2

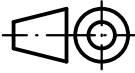
Flathead screw

				Dat.	Name	 <p>All Dim. in mm Orig. Size DIN A 4</p>	D-Sub Hoods 9 POLES with SHELL	Maßstab/ Scale
			Detail.	27/02/03	S.H.			1 : 1
			Insp.					
			Stand.					
EC01696	20/04/10	SC	HARTING EURL F-95972 Paris				TB 09 67 009 0573	Blatt/ Page
31392	27/02/03	S.H.						1 / 1
Mod.	Dat.	Name						Sub.

D

C

B

A