

LPCXpresso Motor Control Kit User's Guide (with LPC1549)

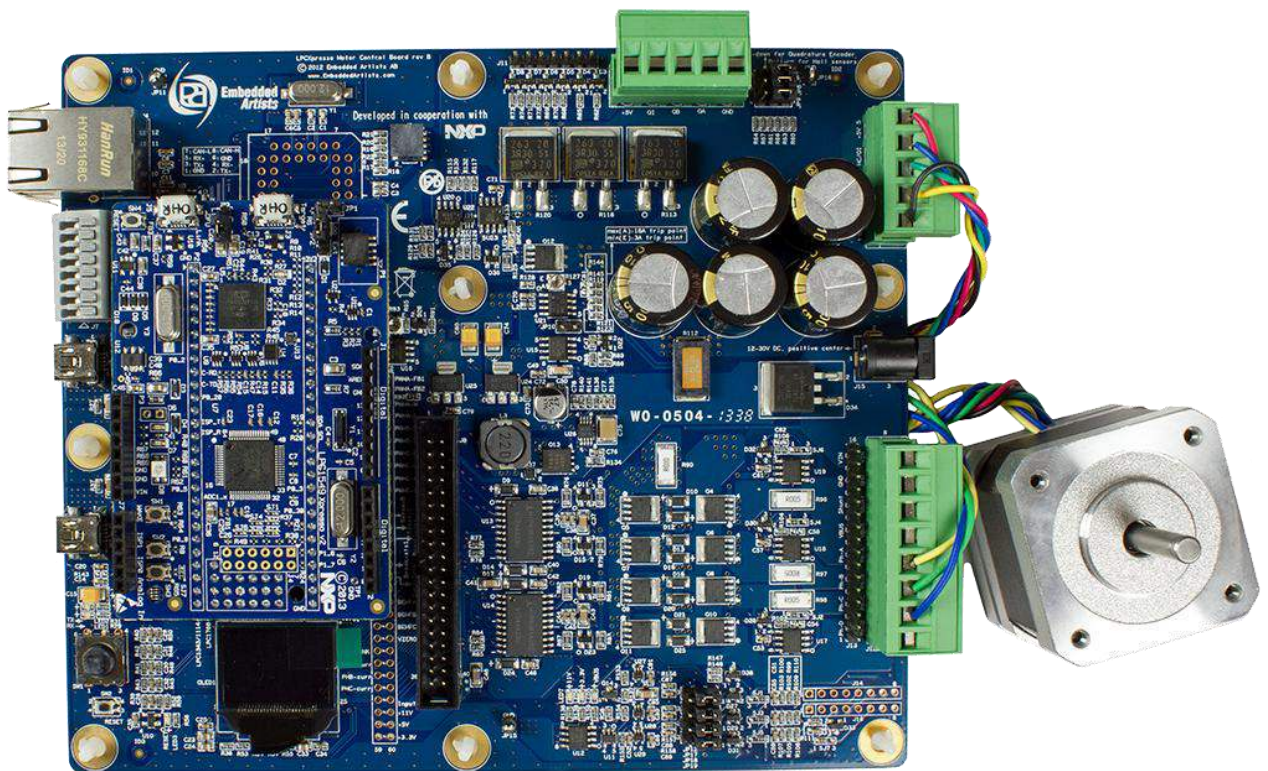

*Get Up-and-Running Quickly and
Start Developing Your Application On Day 1!*

Embedded Artists AB

Davidshallsgatan 16
211 45 Malmö
Sweden

info@EmbeddedArtists.com
<http://www.EmbeddedArtists.com>

Copyright 2011-2014 © Embedded Artists AB. All rights reserved.

No part of this publication may be reproduced, transmitted, transcribed, stored in a retrieval system, or translated into any language or computer language, in any form or by any means, electronic, mechanical, magnetic, optical, chemical, manual or otherwise, without the prior written permission of Embedded Artists AB.

Disclaimer

Embedded Artists AB makes no representation or warranties with respect to the contents hereof and specifically disclaim any implied warranties or merchantability or fitness for any particular purpose. Information in this publication is subject to change without notice and does not represent a commitment on the part of Embedded Artists AB.

Feedback

We appreciate any feedback you may have for improvements on this document. Please send your comments to support@EmbeddedArtists.com.

Trademarks

All brand and product names mentioned herein are trademarks, services marks, registered trademarks, or registered service marks of their respective owners and should be treated as such.

Table of Contents

1	Document Revision History	5
2	Introduction	6
2.1	Features	6
2.2	ESD Precaution	7
2.3	General Handling Care	7
2.4	Code Read Protection	7
2.5	CE Assessment	8
2.6	Other Products from Embedded Artists	8
2.6.1	Design and Production Services	8
2.6.2	OEM / Education / QuickStart Boards and Kits	8
3	Introduction	9
3.1	Board Structure	9
3.2	Motor Control Overview	10
3.3	Usage of CPU Pins	10
3.3.1	Notes about LPC1549 control	12
3.3.2	Notes about LPC1114 control	12
3.3.3	Notes about LPC11C24 control	13
3.3.4	Notes about LPC1343 control	13
3.3.5	Notes about LPC176x control	13
4	LPCXpresso Motor Control Board Design	14
4.1	Phase Control	15
4.2	Phase Measurement	15
4.3	Input Stage and Brake Functionality	15
4.4	Power Supply	16
4.5	Sensor Inputs	16
4.6	Controlling MCU, Expansion connector (J8) and JP6	16
4.6.1	LPCXpresso LPC1549	16
4.6.2	LPCXpresso LPC1114/LPC11C24/LPC1343	16
4.6.3	LPCXpresso LPC176x	16
4.6.4	Other controlling MCUs	16
4.7	Communication Interfaces	17
4.7.1	USB-to-UART Bridge Interface	17
4.7.2	USB Interface	18
4.7.3	CAN Interface	18
4.7.4	RS422/RS485 Interface	18
4.7.5	Ethernet Interface	18
4.8	HMI	19
4.9	Debug	19
4.10	Known Board Design Issues	19
4.11	Default Jumpers Positions	21

5	Getting Started	22
5.1	Kit Content and Preparation	22
5.1.1	Step 1: Mount LPCXpresso LPC1549 board	22
5.1.2	Step 2: BLDC Motor Preparation	23
5.1.3	Step 3: Connect Power Supply	24
5.1.4	Step 4: Loading the Demo Application	24
5.2	Installing USB Driver	28
5.3	Demo Application	29
5.4	Compiling the Demo Application	29
5.5	Things to Note/Known Issues	31
5.5.1	Evaluation Platform – Not for End-products	31
5.5.2	Power Supply	31
5.5.3	Screw Connectors	31
6	Troubleshooting	32
6.1	Powering	32
6.2	Download Demo Application to LPCXpresso Board	33
6.3	Connect LPCXpresso Board	33
6.4	Power Electronics and Motor	34
7	Further Information	35

1 Document Revision History

<i>Revision</i>	<i>Date</i>	<i>Description</i>
PA1	2011-02-01	First (incomplete) version
PA2	2011-02-09	Second (more complete) version
PA3	2011-02-14	Preliminary version
PA4	2011-02-26	Corrected some smaller errors in text (demo application is not preloaded) and text in Fig 20.
PA5	2011-04-24	Added information about LPCXpresso LPC176x usage. Added 7) in section 4.10.
PA6	2011-11-30	Corrected spelling error
A	2012-01-13	Added note about CE marking.
B	2012-07-12	Added information about hardware revision B
PC1	2014-01-23	Added information about LPC1549 as controlling MCU.
PC2	2014-01-24	Updated product photos.
PC3	2014-02-13	Updated LPCXpresso descriptions for LPC1549. Corrected description for joystick orientation.
PC4	2014-07-22	Corrected information in section 5.4 about where to download the demo application.

2 Introduction

Thank you for buying Embedded Artists' *LPCXpresso Motor Control Kit* based on NXP's motor control solutions. The board has been developed in close cooperation with NXP. The kit contains an LPCXpresso board with LPC1549 target, which has a Cortex-M3 core, as motor controller. Several other NXP MCUs can also be used with the board to demonstrate motor control.

This document is a User's Guide that describes the combination of the *LPCXpresso Motor Control Board* and the LPCXpresso LPC1549, together forming the *LPCXpresso Motor Control Kit*.

Note that this manual only covers the *LPCXpresso Motor Control Kit* in combination with LPC1549. There is another version of the kit that uses the LPC1114. Another version of this manual covers this combination.

2.1 Features

Embedded Artists' *LPCXpresso Motor Control Kit* makes it possible for you to get started with motor control prototyping immediately. It is a universal platform for low voltage motor control based on NXP's MCUs. With this platform it is possible to control BLDC, BLAC, stepper and dual brushed DC motors. The board has been designed for evaluation and is not designed for final integration into end-products performing motor control.

- Controller MCU
 - Socket for LPCXpresso LPC1549 and LPC176x
 - Socket for LPCXpresso LPC1114, LPC11C24 and LPC1343
 - Socket for LPC1xxx in PLCC44
 - Expansion connector for control by LPC1800/LPC4000/LPC2900 families, or other
- Phase Control
 - 4 phases (based on NXP PMSN2R6-40YS NMOSFET), accessed via screw terminals
 - Phase control support 100% duty cycle
 - Voltage measurement (on three phases and virtual ground)
 - Current measurement (in-phase on three phases and common low-side)
 - Input current measurement, including over-current trip
 - Brake functionality
 - Hall & QEI sensor inputs, connected via screw terminals
 - Temperature sensor
 - 12-30V input voltage, 17A peak current (max 300W output)
 - On-board 15W power supply (+11V, +5V, +3.3V)
- Communication Interfaces
 - USB interface (must be supported by controlling MCU)
 - Ethernet interface (must be supported by controlling MCU)
 - CAN interface (must be supported by controlling MCU)
 - RS422/485 interface
 - UART-to-USB interface

- User Interface
 - 5-key joystick switch
 - 96x64 pixel OLED
- Other
 - Reset pushbutton
 - I2C-E2PROM
 - SWD/JTAG connector
- Dimensions
 - 200 x 150 mm
- Power Supply Input
 - 2.1mm input jack, or via screw terminals
 - 12-30V, 17A max

2.2 ESD Precaution

Please note that the *LPCXpresso Motor Control Board* and the *LPCXpresso LPC1549 Board* come without any case/box and all components are exposed for finger touches – and therefore extra attention must be paid to ESD (electrostatic discharge) precaution.

Make it a habit always to first touch the metal surface of one of the USB or Ethernet connectors for a few seconds with both hands before touching any other parts of the boards. That way, you will have the same potential as the board and therefore minimize the risk for ESD.



Note that Embedded Artists does not replace boards that have been damaged by ESD.

2.3 General Handling Care

Handle the *LPCXpresso Motor Control Board* and the *LPCXpresso LPC1549 Board* with care. The boards are not mounted in a protective case/box and are not designed for rough physical handling. Connectors can wear out after excessive use. The boards are designed for evaluation and prototyping use, and not for integration into end-products.

The *LPCXpresso Motor Control Board* has an OLED display. Do not exercise pressure on the display glass area or the flex cable connecting the display to the pcb. That will damage the display.

Note that Embedded Artists does not replace boards where the OLED has been improperly handled.

Some components on the *LPCXpresso Motor Control Board* can become very hot during normal operation. The BLDC motor is powerful and can cause damage if improperly used.

Be careful when working with the board and BLDC motor. Pay extra attention to safety precaution.

2.4 Code Read Protection

The LPC15494 has a Code Read Protection function (specifically CRP3, see LPC1549 datasheet/user's manual for details) that, if enabled, will make the LPC1549 impossible to reprogram (unless the user program has implemented such functionality).

Note that Embedded Artists does not replace LPCXpresso LPC1549 boards where the LPC1549 has CRP3 enabled. It's the user's responsibility to not invoke this mode by accident.

2.5 CE Assessment

The *LPCXpresso Motor Control Kit* (consisting of the *LPCXpresso Motor Control Board*, *LPCXpresso LPC1549 Board*, 24V power supply and BLDC motor) is CE marked. See separate *CE Declaration of Conformity* document.

The *LPCXpresso Motor Control Kit* is a class A product. In a domestic environment this product may cause radio interference in which case the user may be required to take adequate measures.

EMC emission test has been performed on the *LPCXpresso Motor Control Kit*. The included *LPCXpresso LPC1114 board*, 24V power supply and BLDC were used along with the default sample application running on the LPC1114. The LPC1114 was the controlling MCU shipped in previous generations of this motor control board. There is no fundamental difference between the LPC1114 and LPC1549 when it comes to EMC when controlling a motor. Therefore the results from the LPC1114 are considered valid for the LPC1549 also. The wires between the *LPCXpresso Motor Control Board* and the BLDC motor were tightly twisted. Connecting other devices to the product via the general expansion connectors on the *LPCXpresso Motor Control Board* may alter EMC emission. The same is true for using other power supplies, other BLDC motors and running other control algorithms on the LPC1114. It is the user's responsibility to make sure EMC emission limits are not exceeded when connecting other devices to the *LPCXpresso Motor Control Board* and when experimenting with different motor control algorithms.

Due to the nature of the *LPCXpresso Motor Control Kit* – an evaluation platform not for integration into an end-product – fast transient immunity tests and conducted radio-frequency immunity tests have not been executed. Externally connected cables are assumed to be less than 3 meters. The general expansion connectors where internal signals are made available do not have any other ESD protection than from the chip themselves. Observe ESD precaution.

2.6 Other Products from Embedded Artists

Embedded Artists have a broad range of LPC800/LPC1000/2000/3000/4000 based boards that are very low cost and developed for prototyping / development as well as for OEM applications. Modifications for OEM applications can be done easily, even for modest production volumes. Contact Embedded Artists for further information about design and production services.

2.6.1 Design and Production Services

Embedded Artists provide design services for custom designs, either completely new or modification to existing boards. Specific peripherals and I/O can be added easily to different designs, for example, communication interfaces, specific analog or digital I/O, and power supplies. Embedded Artists has a broad, and long, experience in designing industrial electronics in general and with NXP's LPC800/LPC1000/2000/3000/4000 microcontroller families in specific. Our competence also includes wireless and wired communication for embedded systems. For example IEEE802.11b/g (WLAN), Bluetooth™, ZigBee™, ISM RF, Ethernet, CAN, RS485, and Fieldbuses.

2.6.2 OEM / Education / QuickStart Boards and Kits

Visit Embedded Artists' home page, www.EmbeddedArtists.com, for information about other *OEM / Education / QuickStart* boards / kits or contact your local distributor.

3 Introduction

The *LPCXpresso Motor Control Kit* is a universal platform for low voltage motor control based on NXP's MCUs. It is possible to control BLDC, BLAC, stepper and dual brushed DC motors. The platform directly supports control via the LPCXpresso LPC1549 (included in kit), LPCXpresso LPC1114, LPCXpresso LPC11C24, LPCXpresso LPC1343 and LPCXpresso LPC176x boards. Note that mbed is **not** directly supported. Other controlling MCUs can however be used via the expansion connector.

There is a 5 minute multimedia overview presentation of the board on the product's web page. This chapter also gives an overview of the board. Note that this presentation is for an earlier revision (rev A) of the motor controller board. Current revision of rev B. The controlling MCU was LPC1114 before. It is now LPC1549.

3.1 Board Structure

The *LPCXpresso Motor Control Board* has a structure as outlined in the picture below. The right side contains the power electronics for driving the motor phases. The left side is the controlling side with sockets for different LPCXpresso boards as well as a PLCC44 socket for LPC1xx processor control. The left side also contains an OLED and a joystick that can serve as a user interface to the system.

In between the two sides, an expansion connector is placed and there is also a special connector that can disconnect the left side from controlling the right side (power electronic side). By disconnecting the left side, the expansion connector can be used to let an arbitrary MCU control the board.

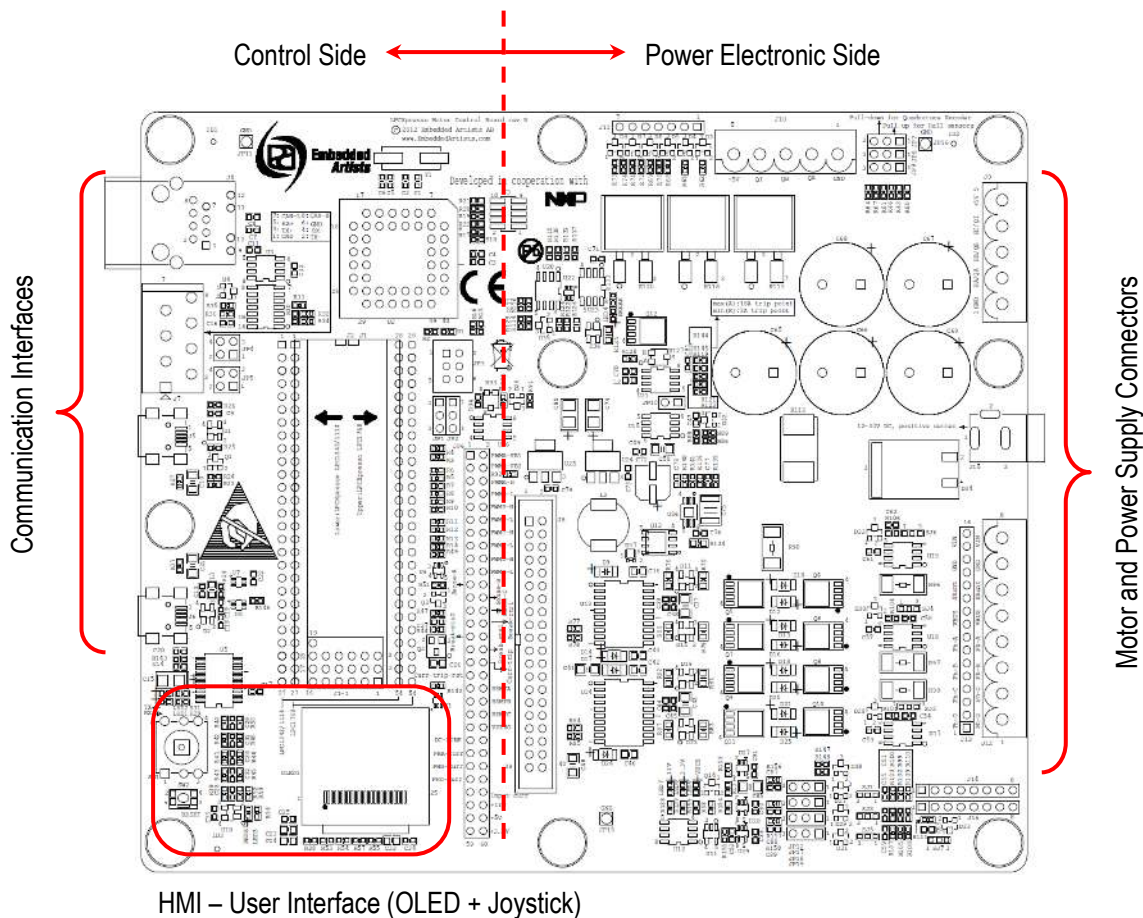

Figure 1 – LPCXpresso Motor Control Board Overview

3.2 Motor Control Overview

The *LPCXpresso Motor Control Board* has four phases that can be controlled. Voltage and in-phase current can be measured on three of these phases. Common virtual ground and common DC-link current can also be measured. For rotor position measurement there are three hall sensor inputs and optional quadrature sensor inputs. These control and measurement possibilities give great flexibility in controlling different kinds of motors.

- BLDC – Brushless DC motor
- BLAC – Brushless AC motor
- Stepper
- Dual brushed DC motor

For a detailed description about motor control principles, please read the different Application Notes from NXP.

3.3 Usage of CPU Pins

The table below lists which MCU pins that are used for controlling the different parts of the LPCXpresso Motor Control board.

Signal	LPC1549 pins in 3/4-phase setup Default	LPC1114/1343 pins in 3-phase setup	LPC1114/1343 pins in 4-phase setup	LPC11C24 pins in 3-phase setup	LPC11C24 pins in 4-phase setup	LPC176x pins in PWM mode	LPC176x pins in Motor Control IP block mode
PWM: PHA-High	PIO0_29/ ACMP2_I3/ SCT2_OUT4	PIO0_1 / CLKOUT / CT32B0_MAT 2 / USB_FTOGGLE	PIO0_1 / CLKOUT / CT32B0_MAT 2 / USB_FTOGGLE	PIO0_1 / CLKOUT / CT32B0_MAT2 / USB_FTOGGLE	PIO0_1 / CLKOUT / CT32B0_MAT 2 / USB_FTOGGLE	P2.0 / PWM1.1 / TXD1	P1.19 / MCOA0 / USB_PPWR / CAP1.1
PWM: PHA-Low	PIO0_6/ ADC0_2/ SCT2_OUT3	PIO0_11 / AD0 / CT32B0_MAT 3	PIO0_11 / AD0 / CT32B0_MAT 3	PIO0_11 / AD0 / CT32B0_MAT3	PIO0_11 / AD0 / CT32B0_MAT 3	P0.9 / I2STX_SDA / MOSI1 / MAT2.3	P1.22 / MCOB0 / USB_PWRD / MAT1.0
PWM: PHB-High	PIO0_0/ ADC0_10/ SCT0_OUT3	PIO0_8 / MISO / CT16B_MAT0	PIO0_8 / MISO / CT16B_MAT0	PIO0_8 / MISO / CT16B_MAT0	PIO0_8 / MISO / CT16B_MAT0	P2.1 / PWM1.2 / RXD1	P1.25 / MCOA1 / MAT1.1
PWM: PHB-Low	PIO0_26/ ACMP0_I3/ SCT3_OUT3	PIO0_9 / MOSI / CT16B0_MAT 1 / SWO	PIO0_9 / MOSI / CT16B0_MAT 1 / SWO	PIO0_9 / MOSI / CT16B0_MAT1 / SWO	PIO0_9 / MOSI / CT16B0_MAT 1 / SWO	P0.8 / I2STX_WS / MISO1 / MAT2.2	P1.26 / MCOB1 / PWM1.6 / CAP0.0
PWM: PHC-High	PIO0_24/ SCT0_OUT6	PIO1_1 / AD2 / CT32B1_MAT 0	PIO1_1 / AD2 / CT32B1_MAT 0	PIO1_1 / AD2 / CT32B1_MAT0	PIO1_1 / AD2 / CT32B1_MAT 0	P2.2 / PWM1.3 / CTS1	P1.28 / MCOA2 / PCAP1.0 / MAT0.0
PWM: PHC-Low	PIO0_1/ ADC0_7/ SCT0_OUT4	PIO1_2 / AD3 / CT32B1_MAT 1	PIO1_2 / AD3 / CT32B1_MAT 1	PIO1_2 / AD3 / CT32B1_MAT1	PIO1_2 / AD3 / CT32B1_MAT 1	P0.7 / I2STX_CLK / SCK1 / MAT2.1	P1.29 / MCOB2 / PCAP1.1 / MAT0.1
PWM: PHD-High	PIO0_3/ ADC0_5/ SCT1_OUT4	Not available	PIO1_9 / CT16B1_MAT 0	Not available	PIO3_3	P2.3 / PWM1.4 / DCD1	P2.3 / PWM1.4 / DCD1
PWM: PHD-Low	PIO1_0	Not available	PIO1_10 / AD6 / CT16B1_MAT 1	Not available	PIO1_10 / AD6 / CT16B1_MAT 1	P0.6 / I2SRX_SDA / SSEL1 / MAT2.0	P0.6 / I2SRX_SDA / SSEL1 / MAT2.0
Hall-A	PIO0_2	PIO2_0 / DTR	PIO2_0 / DTR	PIO2_0 / DTR	PIO2_0 / DTR	P1.20 / MCIO / PWM1.2 / SCK0	P1.20 / MCIO / PWM1.2 / SCK0
Hall-B	PIO0_30	PIO2_1 / DSR	PIO2_1 / DSR	PIO2_1 / DSR	PIO2_1 / DSR	P1.23 / MCIO / PWM1.4 /	P1.23 / MCIO / PWM1.4 / MIS00

Hall-C	PIO0_17					MISO0	
QEI-PHA	Only available at expansion connector	Only available at expansion connector	Only available at expansion connector	Only available at expansion connector	Only available at expansion connector	P1.24 / MC12 / PWM1.5 / MOSI0	P1.24 / MC12 / PWM1.5 / MOSI0
QEI-PHB	Only available at expansion connector	Only available at expansion connector	Only available at expansion connector	Only available at expansion connector	Only available at expansion connector	Only available at expansion connector	Only available at expansion connector
QEI-Index	Only available at expansion connector	Only available at expansion connector	Only available at expansion connector	Only available at expansion connector	Only available at expansion connector	Only available at expansion connector	Only available at expansion connector
Analog: BEMFA	PIO0_9/ ADC1_1	PIO1_4 / AD5 / CT32B1_MAT3 / WAKEUP	PIO1_4 / AD5 / CT32B1_MAT3 / WAKEUP	PIO1_4 / AD5 / CT32B1_MAT3 / WAKEUP	PIO1_4 / AD5 / CT32B1_MAT3 / WAKEUP	P0.23 / AD0.0 / I2SRX_CLK / CAP3.0	P0.23 / AD0.0 / I2SRX_CLK / CAP3.0
Analog: BEMFB	PIO0_10/ ADC1_2	PIO1_10 / AD6 / CT16B1_MAT1	Not available	PIO1_10 / AD6 / CT16B1_MAT1	Not available	P0.25 / AD0.2 / I2SRX_SDA / TXD3	P0.25 / AD0.2 / I2SRX_SDA / TXD3
Analog: BEMFC	PIO1_3/ ADC1_5	PIO1_11 / AD7	PIO1_11 / AD7	PIO1_11 / AD7	PIO1_11 / AD7	P1.30 / VBUS / AD0.4	P1.30 / VBUS / AD0.4
Analog: VZERO	PIO0_16/ ADC1_9	Not available	Not available	Not available	Not available	P0.2 / TXD0 / AD0.7	P0.2 / TXD0 / AD0.7
Analog: PHA-curr	PIO0_4/ ADC0_4	Not available	Not available	Not available	Not available	P0.24 / AD0.1 / I2SRX_WS / CAP3.1	P0.24 / AD0.1 / I2SRX_WS / CAP3.1
Analog: PHB-curr	PIO0_5/ ADC0_3	Not available	Not available	Not available	Not available	P0.26 / AD0.3 / AOUT / RXD3	P0.26 / AD0.3 / AOUT / RXD3
Analog: PHC-curr	PIO0_7/ ADC0_1	Not available	Not available	Not available	Not available	P1.31 / SCK1 / AD0.5	P1.31 / SCK1 / AD0.5
Analog: Current, either DC-curr. or Input-curr.	PIO0_8/ ADC0_0	PIO1_0 / AD1 / CT32B1_CAP0	PIO1_0 / AD1 / CT32B1_CAP0	PIO1_0 / AD1 / CT32B1_CAP0	PIO1_0 / AD1 / CT32B1_CAP0	P0.3 / RXD0 / AD0.6	P0.3 / RXD0 / AD0.6
Analog mux-ctrl	PIO0_12	PIO1_8 / CT16B1_CAP0	PIO1_8 / CT16B1_CAP0	PIO1_8 / CT16B1_CAP0	PIO1_8 / CT16B1_CAP0	P0.28 / SCL0 / USB_SCL	P0.28 / SCL0 / USB_SCL
Brake: status0	PIO0_15	PIO2_11 / SCK	PIO2_11 / SCK	PIO2_11 / SCK	PIO2_11 / SCK	P1.27 / CLKOUT / USB_OVRCR / CAP0.1	P1.27 / CLKOUT / USB_OVRCR / CAP0.1
Brake: status1	PIO1_1	PIO0_2 / SSEL / CT16B0_CAP0	PIO0_2 / SSEL / CT16B0_CAP0	PIO0_2 / SSEL / CT16B0_CAP0	PIO0_2 / SSEL / CT16B0_CAP0	P2.5 / PWM1.6 / DTR1	P2.5 / PWM1.6 / DTR1
Brake: ctrl	PIO0_25	PIO1_9 / CT16B1_MAT0	Not available	PIO3_3	Not available	P3.25 / MAT0.0 / PWM1.2	P3.25 / MAT0.0 / PWM1.2
Input current trip	PIO0_27	PIO0_7 / CTS	PIO0_7 / CTS	PIO0_7 / CTS	PIO0_7 / CTS	P2.12 / EINT2 / I2STX_WS P1.21 / MCABORT / PWM1.3 / SSEL0	P2.12 / EINT2 / I2STX_WS P1.21 / MCABORT / PWM1.3 / SSEL0
Input current reset	PIO0_28	PIO3_5 (or PIO2_5 on LPC1343)	PIO3_5 (or PIO2_5 on LPC1343)	Not available	Not available	P0.18 / DCD1 / MOSI0 / MOSI	P0.18 / DCD1 / MOSI0 / MOSI
UART-	PIO0_18	PIO1_7 / TXD /	PIO1_7 / TXD /	PIO1_7 / TXD /	PIO1_7 / TXD /	P0.15 / TXD1 /	P0.15 / TXD1 /

TXD		CT32B0_MAT1	CT32B0_MAT1	CT32B0_MAT1	CT32B0_MAT1	SCK0 / SCK	SCK0 / SCK
UART-RXD	PIO0_13	PIO1_6 / RXD / CT32B0_MAT0	PIO1_6 / RXD / CT32B0_MAT0	PIO1_6 / RXD / CT32B0_MAT0	PIO1_6 / RXD / CT32B0_MAT0	P0.16 / RXD1 / SSEL0 / SSEL	P0.16 / RXD1 / SSEL0 / SSEL
UART-mux ctrl	PIO1_9	PIO3_4 (or PIO2_4 on LPC1343)	PIO3_4 (or PIO2_4 on LPC1343)	PIO2_6	PIO2_6	P0.27 / SDA0 / USB_SDA	P0.27 / SDA0 / USB_SDA
RS485-ctrl	PIO1_10	PIO1_5 / RTS / CT32B0_CAP0	PIO1_5 / RTS / CT32B0_CAP0	PIO1_5 / RTS / CT32B0_CAP0	PIO1_5 / RTS / CT32B0_CAP0	P0.22 / RTS1 / TD1	P0.22 / RTS1 / TD1
Joystick-left	PIO1_4	PIO2_7	PIO2_7	PIO2_7	PIO2_7	P2.7 / RD2 / RTS1	P2.7 / RD2 / RTS1
Joystick-right	PIO1_6	PIO2_8	PIO2_8	PIO2_8	PIO2_8	P2.8 / TD2 / TXD2	P2.8 / TD2 / TXD2
Joystick-up	PIO1_7	PIO2_9	PIO2_9	Not available	Not available	P2.10 / EINT0 / NMI	P2.10 / EINT0 / NMI
Joystick-down	PIO1_8	PIO2_10	PIO2_10	PIO2_10	PIO2_10	P2.11 / EINT1 / I2STX_CLK	P2.11 / EINT1 / I2STX_CLK
Joystick-center	PIO1_5	PIO2_6	PIO2_6	Not available	Not available	RDP2.6 / PCAP1.0 / R11	RDP2.6 / PCAP1.0 / R11
OLED Volt-EN	PIO0_2	PIO2_3 / RI	PIO2_3 / RI	PIO2_3 / RI	PIO2_3 / RI	DP0.21 / R11 / RD1	DP0.21 / R11 / RD1
I2C-SDA	PIO0_23 / I2C0_SDA	PIO0_5 / SDA	PIO0_5 / SDA	PIO0_5 / SDA	PIO0_5 / SDA	P0.10 / TXD2 / SDA2 / MAT3.0	P0.10 / TXD2 / SDA2 / MAT3.0
I2C-SCL	PIO0_22 / I2C0_SCL	PIO0_4 / SCL	PIO0_4 / SCL	PIO0_4 / SCL	PIO0_4 / SCL	P0.11 / RXD2 / SCL2 / MAT3.1	P0.11 / RXD2 / SCL2 / MAT3.1

3.3.1 Notes about LPC1549 control

The LPC1549 is the main controller for the *LPCXpresso Motor Control Board*. Its pin usage is marked in gray in the table above.

All four phases can be controlled and all analog measurements can be done via the on-chip ADC.

The USB interface is supported via the USB connector (mini-B) on the LPCXpresso LPC1549 board. Note that the USB connector on the *LPCXpresso Motor Control Board* is not connected to the LPC1549.

The CAN interface (with connector on the *LPCXpresso Motor Control Board*) is supported.

The Ethernet communication interface is not supported simply because the LPC1549 does not support this interface on-chip.

The QEI interface is not connected to the LPC1549. This interface is only available via the expansion connector.

3.3.2 Notes about LPC1114 control

The LPC1114 is limited in the number of available pins. All features of the *LPCXpresso Motor Control Board* cannot be used on the board.

The default setup is to control three (of the four) phases. All four phases can however be controlled. The trade-off is to lose the back EMF analog signal for phase B and the brake control signal.

In-phase current measurement and virtual-ground voltage measurement analog signals are not available for the processor.

The USB, CAN and Ethernet communication interfaces are not available simply because the LPC1114 does not support these interfaces on-chip.

The QEI interface is not connected to the LPC1114. This interface is only available via the expansion connector.

3.3.3 Notes about LPC11C24 control

The limitations for LPC11C24 are the same as for the LPC1114, as described above. The only differences are (pin numbering refers to the 2x27 pos edge connector of the LPCXpresso board):

- The LPC11C24 has a CAN interface, which the LPC1114 does not have.
- Pin PIO1_9 is not available (was pin 42). Instead pin PIO3_3 is connected to pin 42. This affects the brake control signal and PhD-H signal.
- PIO3_3 moved (from pin 53) to pin 42 (see above).
- PIO2_6 moved (from pin 48) to pin 46. This makes it impossible to read the joystick right key.
- Pin PIO3_4 is not available (was pin 46). This affects the uart-mux signal, signal PIO2_6 shall be used instead.
- Pin PIO3_5 is not available (was pin 47). This makes it impossible to reset the input over-current trip.
- Pin PIO2_9 is not available (was pin 51). This makes it impossible to read the joystick center key.

3.3.4 Notes about LPC1343 control

The limitations for LPC1343 are the same as for the LPC1114, as described above. The only difference is that the LPC1343 has an USB interface, which the LPC1114 does not have.

3.3.5 Notes about LPC176x control

The LPC176x has more pins and can measure the same analog signals as the LPC1114/1343 plus virtual ground (voltage) and in-chase current for phase A, B and C.

The LPC176x can control all four phases simultaneous without any trade-off. The PWM signals can be generated in two different ways; either via the PWM peripheral block or via the motor control peripheral block. The signals for these two different blocks are connected together, so the block that is inactive must set the associated pins in input mode (so there is no interference with the block that is generating the phase control signals).

The QEI interface is not connected to the LPC176x. This interface is only available via the expansion connector.

Note that revision C of the LPCXpresso LPC1769 board is needed to fit the connectors. Revision C has been the revision shipped of this board since summer 2013.

4 LPCXpresso Motor Control Board Design

This chapter contains information about the general design of the *LPCXpresso Motor Control Board* and how to set the few jumpers on the board. The schematic can be downloaded in PDF from the support page, and is recommended to have printed out while reading this chapter.

The datasheets for specific components must be read in order to obtain detailed and specific information for different functions.

The following of this chapter is a walkthrough of the design from a functionality perspective. The picture below gives an overview of where the different functions are located on the board. Note that there are two different versions of the hardware, rev A and rev B. The two versions are functionally equivalent. Rev B has slightly less noise in the phase current measurement (compared to rev A) and digital phase voltage measurement (which does not exist at all on rev A boards). This document version only deals with rev B of the base board and it looks like below.

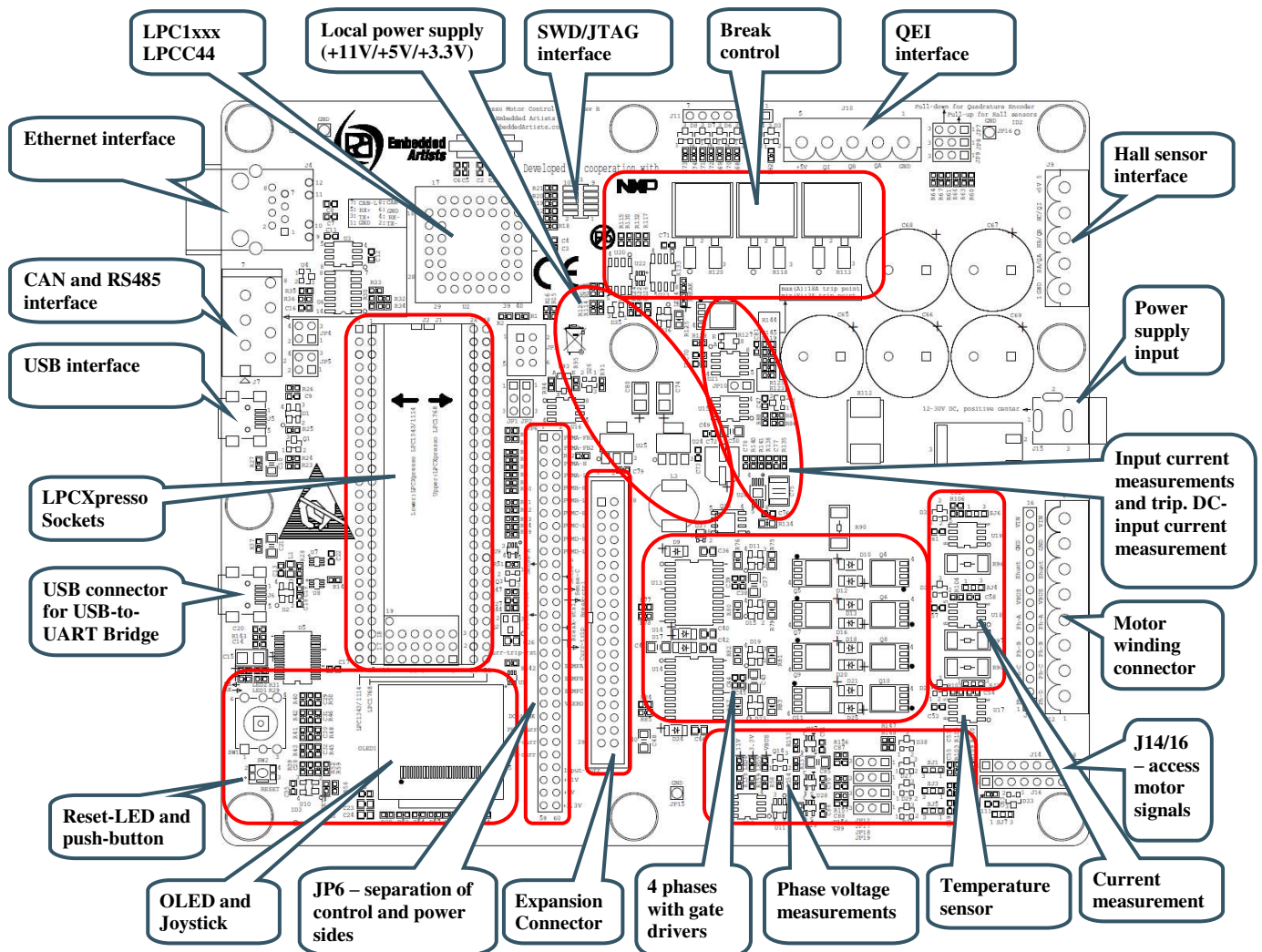

Figure 2 – LPCXpresso Motor Control Board Detailed Overview, rev B

4.1 Phase Control

There are four phases with full control. The gate drivers are based on the chip HIP4081AIBZ from Intersil. This chip supports 100% duty cycle. See the datasheet for details.

As phase transistors, the N-channel MOSFET PSMN2R6-40YS from NXP is used. This MOSFET has the following rating: 40V/100A and $R_{ds\ on}$ 2.8 mOhm.

4.2 Phase Measurement

It is possible to measure voltage and current individually on three of the four phases. In situation where the fourth phase is used, there is no need for voltage and current measurement on the fourth phase.

Phase voltages are measured with 1/12 division and is low-pass filtered. An extra capacitor can be enabled by inserting jumpers on JP11-JP13, respectively, to further low-pass filter the voltage measurement signals.

In-phase currents are measured via 5milli-ohm series resistors and AD8210 (U17-U19). The chip offers x20 amplification of the current measurement signal and is bidirectional. When zero current the output will be $V_{REF}/2 = 3.3/2 = 1.65V$. Increasing voltage reflect current out from the board.

There is also a common virtual ground voltage measurement signal, which is used in some motor control algorithms.

All voltage and current sense signals are available on J14/J16 along with +5V supply voltage. It is possible to create custom voltage and current measurement solutions via J14/J16. SJ1-SJ7 can switch from the standard measurement solution to the custom solution.

It is possible to measure phase A output signal via an adjustable comparator (U16 and R93). This can be used to measure the gate driver delay (and to calibrate the motor control algorithm).

To simplify connection to an oscilloscope, all motor winding signals along with input voltage, VBUS and shunt are available on J13 (just beside the screw connector J12).

4.3 Input Stage and Brake Functionality

There are two input connectors for the power supply; either the 2.1mm power jack or via screw connector J12. The power supply included in the kit has a 2.1mm power jack connector with positive center. The voltage input (on both connectors) is reverse polarity protected via D34.

The reverse polarity protection diode (D34) also functions as part of the brake functionality. If the motor is spinning in generator mode (and is hence generating current) the motor voltage (schematic signal net VBUS) will increase to a point where it will damage the electronics. D34 is used to measure the voltage increase and if above a threshold, Q12 will connect the three power dissipation resistors (R113, R118 and R120) to VBUS. This will quickly consume power and slow down the spinning motor (i.e., function as a brake).

R112 is used to measure the input current via U21 (a high-side current-shunt monitor). This chip has x20 amplification so 10A will generate a 2V measurement signal. It also has a comparator which makes it possible to set a trip point for over-current protection. The comparator output is directly connected to the gate drivers and will disable these in case of an over-current situation. The over-current trip point is adjustable between 3A and 18A with trimming potentiometer R127.

The input current measurement signal is connected to an analog input on the LPCXpresso target boards, via analog multiplexor U1. Signal AIN-CTRL shall be high to measure the input current. If low, the DC-link current measurement signal is instead connected (the common low-side current of the phase drivers).

The board contains five big reservoir capacitors (5000uF, C65-C69). These capacitors will handle the current spikes from the PWM control of the motor. They also make the input power supply requirement less stringent in supplying large currents spikes. There is however a trade-off; there will be a high

current spike when the power supply is connected. Some power supplies might go into over-current protection because of this startup current spike.

4.4 Power Supply

The power supply input voltage is taken from the motor supply. It is in the range from 12-30V minus one diode drop (D34). Three voltages are generated; +11V, +5V and +3.3V. A switching regulator, U26 - LM5085MYE, is used to generate +11V/1.5A. The converter is designed for 15W. The +11V is needed for the gate drivers and the OLED display. The +11V voltage is also used to generate +5V and +3.3V via simple linear voltage regulators (U24 and U25). +5V is used to power external Hall sensors and the current measurement circuits. The +3.3V is used to power the rest of the board.

4.5 Sensor Inputs

There are two main sensor input connectors, J9 and J10. J9, that is normally used, can either interface Hall sensors or a quadrature sensor. There are three jumpers (JP7-JP9) to enable optional pullup or pulldown resistors. Normally these jumpers are set to enable the pullup resistors since the kit contains a BLDC motor with Hall sensors.

There is also J10 that is a quadrature sensor input. The signals from this connector are only available on the expansion connector since no LPCXpresso board has enough pins to handle these signals.

The board also contains an i2c temperature sensor (LM75A). It is supposed to measure the temperature on the power electronics, but due to position on board and general mounting of the board, the temperature measured is not precise. It is included for completeness in demo applications since real motor control applications must monitor the temperature of the controller.

All sensor input signals are available on J11 to simplify connection to an oscilloscope or logic analyzer.

4.6 Controlling MCU, Expansion connector (J8) and JP6

The *LPCXpresso Motor Control Board* has been designed for direct interface to a number of LPCXpresso boards; LPC1549, LPC1114, LPC11C24, LPC1343 and LPC176x. There is also a PLCC44 socket for LPC11xx processors.

Section 3.3 contains a description of which pins to interface the *LPCXpresso Motor Control* board are used on different LPCXpresso boards.

4.6.1 LPCXpresso LPC1549

This is the default configuration and is what is delivered with the *LPCXpresso Motor Control Kit*.

4.6.2 LPCXpresso LPC1114/LPC11C24/LPC1343

Note that in case an LPCXpresso LPC1114/LPC11C24/LPC1343 board shall be used, pin-lists for the two 27 pos edge connectors must also be soldered.

4.6.3 LPCXpresso LPC176x

Note that in case an LPCXpresso LPC176x board shall be used, pin-lists for the two 27 pos edge connectors must also be soldered. Also the 19 signal positions in between the edge connectors must have pin-lists soldered.

Note that revision C of the LPCXpresso LPC1769 board is needed to fit the connectors. Revision C has been the revision shipped of this board since summer 2013.

4.6.4 Other controlling MCUs

There is also an expansion connector (J8, see schematic page 6) where all relevant signals for the power electronic side are available. Other MCUs can be used to control the *LPCXpresso Motor Control Board*, like the LPC2900, LPC1800 and LPC4300 families.

The control side of the board can be disconnected, if needed, by removing the solder bumps in JP6.

4.7 Communication Interfaces

There are multiple communication interfaces on the *LPCXpresso Motor Control Board*. The picture below gives a detailed overview of the interfaces and the following sub-sections explain each interface in more detail.

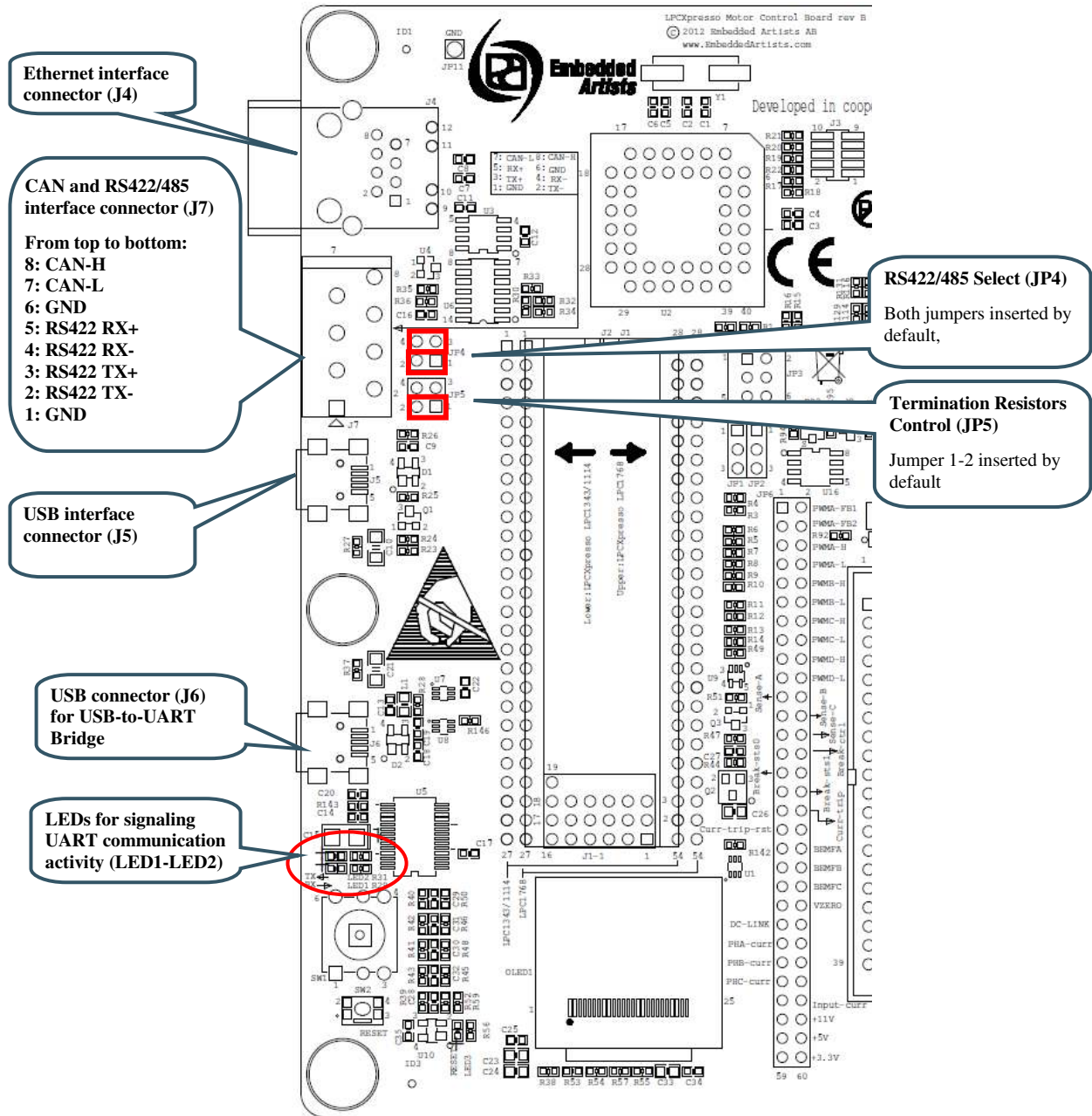

Figure 3 – LPCXpresso Motor Control Board Communication Interfaces, rev B

4.7.1 USB-to-UART Bridge Interface

There is a UART-to-USB bridge on the board. This is to simplify connection to a PC because serial ports are not so common any more, especially not on laptops. It is the controlling MCU's UART that is connected to the USB channel. This UART can for example be used as the console channel for applications. Printf() output is typically directed to this UART channel.

The UART-to-USB bridge is based on the chip FT232RL from FTDI. A driver is typically needed to be installed on the PC side. The driver creates a virtual COM port on the PC that represents the UART channel. Any program on the PC can connect to this COM port for communication with the controlling MCU on the board. There are two LEDs (Transmit – LED2 and Receive – LED1) that signal communication activity.

Note that signal UART_RS485 must be high in order to connect the UART signals to the USB-to-UART bridge. The signal UART_RS485 controls a multiplexor (U7/U8) for the UART_TXD/UART_RXD signals. The MCU UART can be connected to either to the USB-to-UART bridge or the RS422/485 interface.

4.7.2 USB Interface

Note that the LPC1549 has an USB interface on the LPCXpresso board. The USB interface on the *LPCXpresso Motor Control Board* is not connected.

The USB interface (J5 on schematic page 4) is currently only supported by the LPCXpresso LPC1343 and LPC176x boards. The controlling MCU must have an on-chip USB interface.

The interface is very straight forward and consists of a mini-B USB connector, ESD protection, VBUS sense and DP pull-up resistor control.

4.7.3 CAN Interface

There is a CAN interface on the board that is based on the NXP chip TJF1051T/3. The interface is straight forward consisting of a CAN transceiver, ESD protection and connector.

The CAN interface (part of connector J7 on schematic page 4) is currently only supported by the LPCXpresso LPC1549 and LPC176x boards. The controlling MCU must have an on-chip CAN interface.

Note that there are no termination resistors in the CAN interface. If needed, such termination resistors must be connected externally.

Note that the *LPCXpresso LPC11C24* has an on-chip CAN-transceiver. The interface connector to this is located on the *LPCXpresso LPC11C24 board*. The CAN interface and associated connector on the *LPCXpresso Motor Control board* is in this case not used.

4.7.4 RS422/RS485 Interface

There is a RS422/485 interface on the board based on SN65HVD35. RS422 has individual transmit and receive pairs, while RS485 share the same signal pair (and is hence half-duplex). By inserting both jumpers in JP4, the two signal pairs are connected and a RS485 interface is created. By removing the jumpers in JP4 a RS422 interface is created. Via JP5 it is also possible to add termination resistors, if needed. Note the different orientation for jumpers in JP4 and JP5.

The transceiver (U6 on schematic page 4) has built-in ESD protection.

Communication direction over the RS485 interface is controlled via signal RS485-RTS and is by default half-duplex (i.e., no simultaneous transmit and receive). A high level enables the transmitter while a low level enables the receiver. It is possible to remove R30 in order to always enable the receiver. The transmitter is still controlled by the signal RS485-RTS.

Note that signal UART_RS485 must be low in order to connect the UART signals to the RS422/485 interface. The signal UART_RS485 controls a multiplexor (U7/U8) for the UART_TXD/UART_RXD signals. The MCU UART can be connected to either to the USB-to-UART bridge or the RS422/485 interface.

4.7.5 Ethernet Interface

The Ethernet interface (J4 on schematic page 4) is currently only supported by the LPCXpresso LPC176x board. The interface is actually just a RJ45 connector with integrated magnetics. The Ethernet-PHY interface is on the LPCXpresso board.

4.8 HMI

The board contains an OLED display and a joystick that can be used as Human-Machine Interface to the motor control application. These components can be found on schematic page 5. The OLED is interfaces via the I2C bus and communication speed is limited to the 400kHz limit of the I2C specification. The OLED requires an external +11V supply. This voltage must be controlled in a timely manner. See the sample driver code from the support page for details and/or read the datasheet for the display.

The 5-key joystick is connected to the controlling MCU via direct digital signals. See direction of the joystick below.

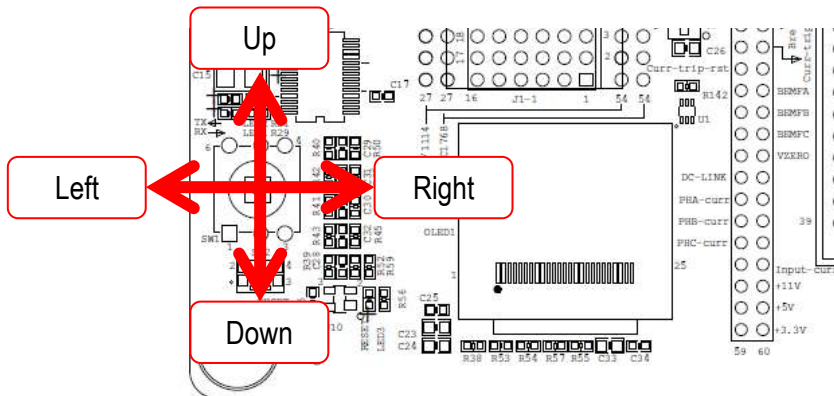

Figure 4 – LPCXpresso Motor Control Board Joystick Directions, rev B

4.9 Debug

There is an SWD/JTAG connector interface (J3 on schematic page 3) that is normally used for the LPC1xx MCU in the PLCC44 socket. J3 is the new and smaller footprint standard ARM debug connector. It has 2x5 pins in 50 mil pitch. The connector supports both the SWD and JTAG interfaces, but LPC11xx/13xx processors only support SWD. Note that not all, and in particular older, JTAG debug probes do not support the SWD interface standard.

When an LPCXpresso boards is used to control the board, the on-board debugger (LPC-Link, LPC-Link2) is typically used to download program code and debugging via the SWD/JTAG interface. In this case there is no need to use J3.

4.10 Known Board Design Issues

This section lists a couple of known design issues that is good to know when using the board for motor control evaluation.

1. The powering and reset structure of the USB-to-UART chip (FT232RL, U5 on schematic page 4) is not optimal in some situations. If a USB cable is not connected, the TX and RX LEDs are on since the chip is not powered. It is no problem with this other than an irritating light from the two LEDs. When using the USB channel to send UART communication to a PC, i.e., when a USB cable is actually connected, the chip will be reset when the internal reset signal is active (for example by the reset push-button). This will cause a new USB enumeration in the PC and it will take a few seconds to complete. During this time, no UART communication will be forwarded over the USB channel. A workaround for this USB enumeration delay is to add a 5 second delay in the application code before the UART is actually used.
2. The three LEDs (LED5-LED7 on schematic page 10) that indicate voltage presence (VBUS, +11V and +3.3V) are quite bright and can get somewhat hot. In case the bright light is irritating, the LEDs can be removed from the board or covered. Note that (de-)soldering on the board voids any warranty.

3. The I2C-temperature sensor (U12 on schematic page 12) is mounted on the board in a way that is inappropriate for real applications. It does not measure the true temperature on the phase driver stages. The temperature sensor is only included for completeness of sample/demo motor control applications. It is suitable to set the temperature trip level to a very low value, i.e., just above room temperature. 40-45 degrees Celsius is a suitable trip level. The voltage indicator LEDs actually heats the temperature sensor somewhat (typically 5-10 degrees Celsius).
4. The five input capacitors have a combined capacitance of 5000uF (C65-C69 on schematic page 10). The high capacitance is needed to smooth the current pulses from the PWM control of the motor. It reduces the requirements on the external power supply.
A (negative) consequence of the high input capacitance is a high inrush current when an external power supply is connected. The over-current protection on some power supplies might be triggered by this. The power supply must be able to handle the high inrush current.
5. The CAN interface does not have any termination resistor. If needed, such termination resistor must be added externally.

4.11 Default Jumpers Positions

Fel! Hittar inte referenskölla. illustrates the default jumper positions as mounted when the board is delivered from Embedded Artists.

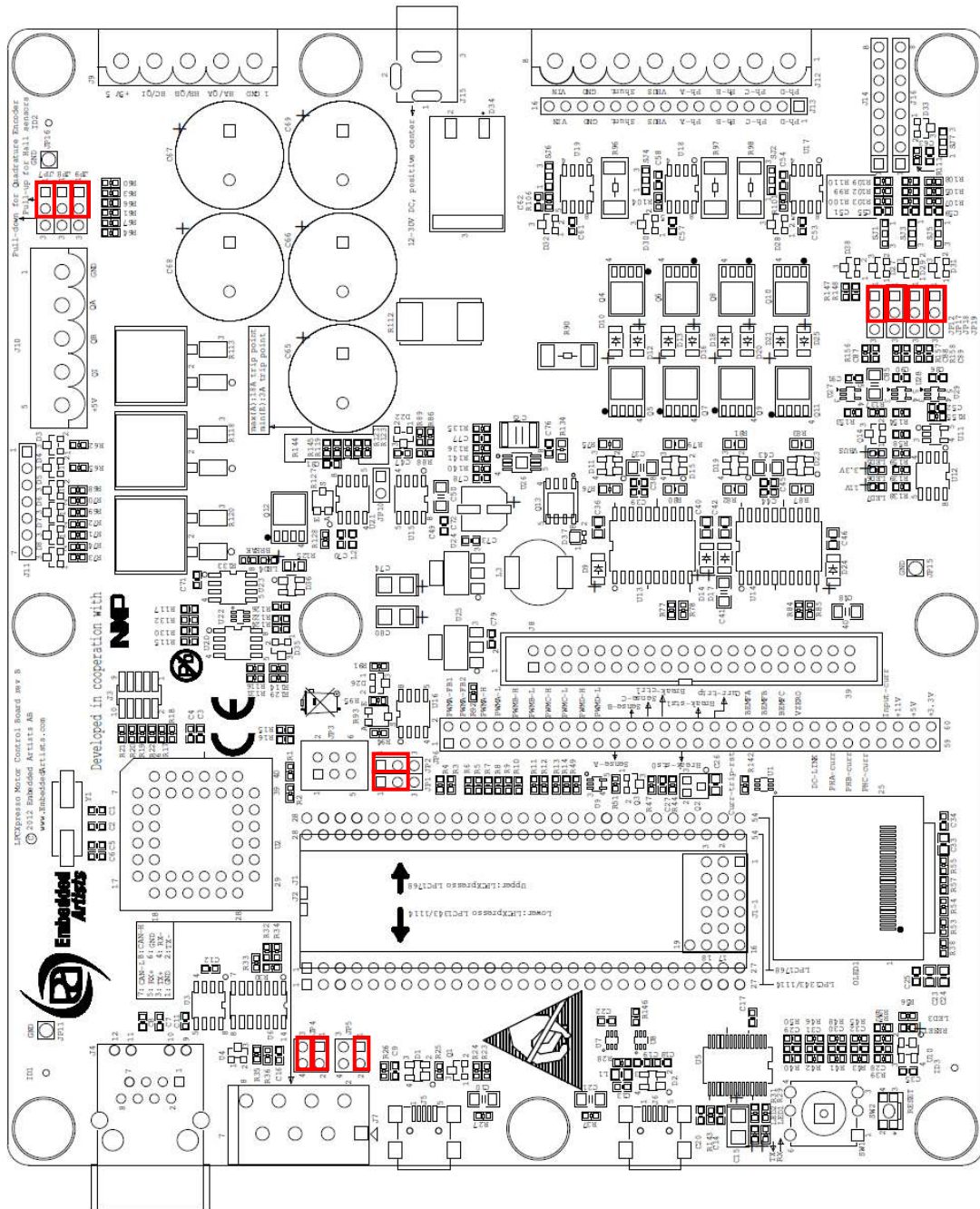

Figure 5 – Default jumper positions, rev B hardware

5 Getting Started

This chapter contains information about how to get acquainted with the *LPCXpresso Motor Control Kit*. **Please read this section first before you start using the board - it will be well spent time!**

5.1 Kit Content and Preparation

The *LPCXpresso Motor Control Kit* is delivered in two boxes. Box #1 contains:

- 1) LPCXpresso Motor Control Board
- 2) LPCXpresso LPC1549 with pin lists soldered.
Note: the demo application is **not** pre-programmed to this board. The demo application has to be downloaded into the board. See description about how to do this further down this chapter.
- 3) USB cable, mini-B to A.
- 4) USB cable, micro-B to A.

Box #2 contains:

- 1) BLDC motor
- 2) Power supply, 24V/60W
- 3) Power cable to power supply (wall connector, EU style).
Adapters for US and UK wall connectors are included as well.

Follow the instructions below to get everything up and running quickly. The picture below illustrates three of the four steps.

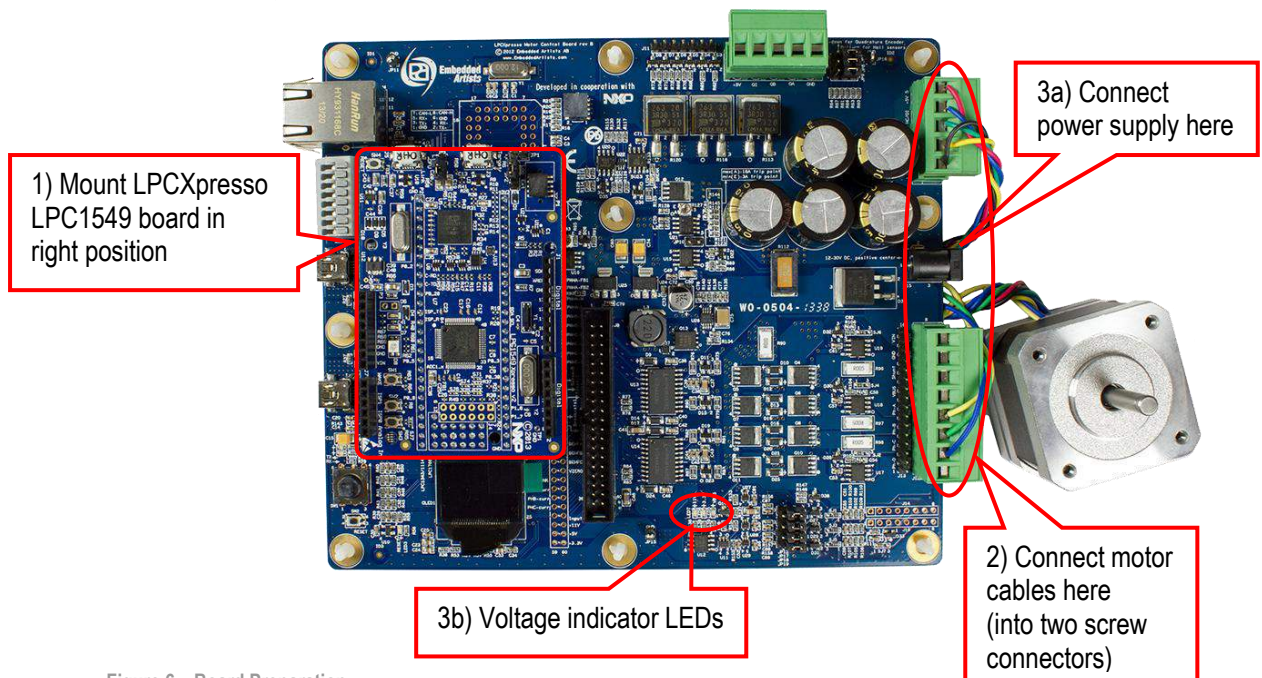

Figure 6 – Board Preparation

5.1.1 Step 1: Mount LPCXpresso LPC1549 board

Mount the LPCXpresso LPC1549 Board on the *LPCXpresso Motor Control Board*. Make sure the LPCXpresso board is mounted in the right position. The left position is for LPCXpresso LPC1114 boards.

Double-check that the pin lists of the LPCXpresso LPC1549 board are correctly inserted into the *LPCXpresso Motor Control Board* (in right position and all pins inserted correctly into the base board socket – no pin should be visible under the LPCXpresso LPC1549 board).

5.1.2 Step 2: BLDC Motor Preparation

The BLDC motor shall be mounted in two screw connectors, see picture below. Note that the cables from the motor come in two groups. Cables shall NOT be mixed between the two groups. The group with five cables goes to the 5 pos connector and the group with 3 cables goes to the 8 pos connector.

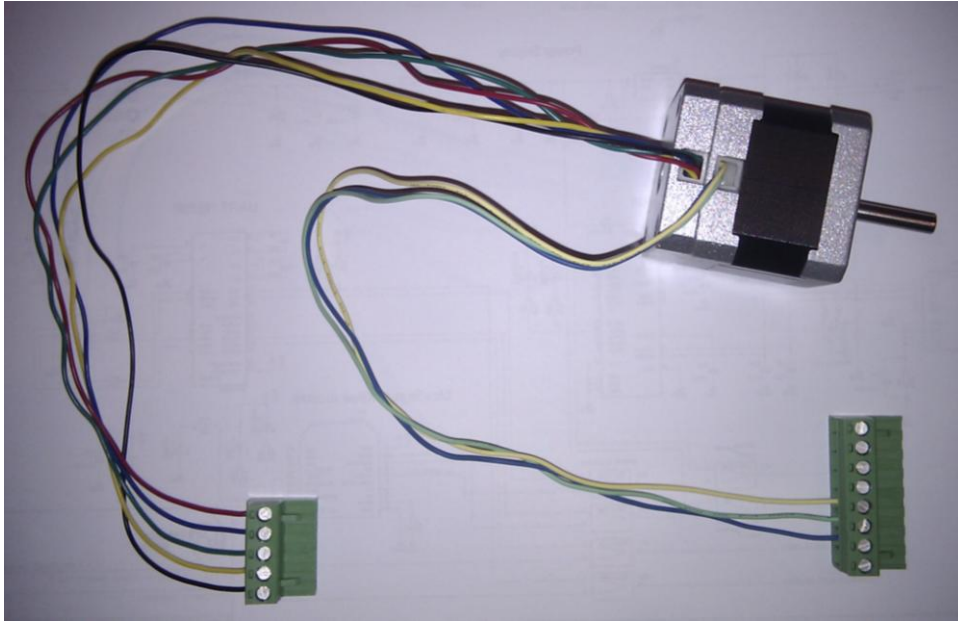

Figure 7 – BLDC motor with screw connectors

The five cables of the 5 pos screw connector shall be mounted as indicated below, from top to bottom: red, blue, green, yellow and black cable.

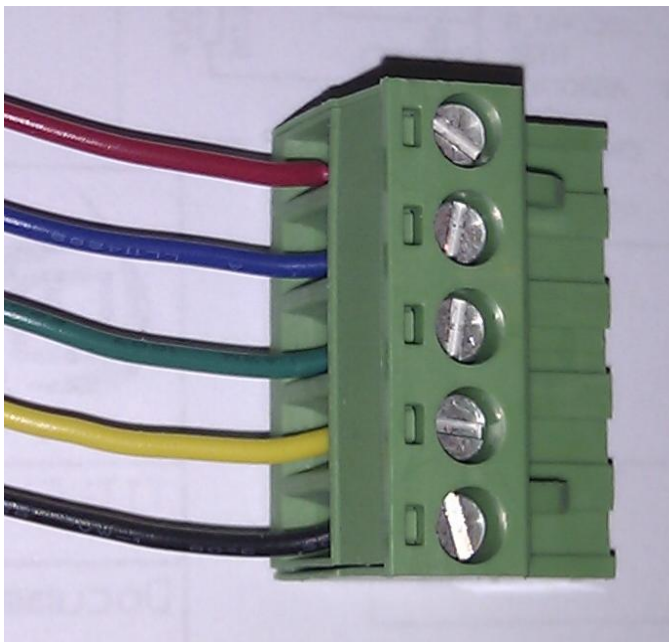

Figure 8 – BLDC motor hall sensor cables

The three cables of the 8 pos screw connector shall be mounted as indicated below, from top to bottom: no, no, no, no, yellow, green, blue, no cable.

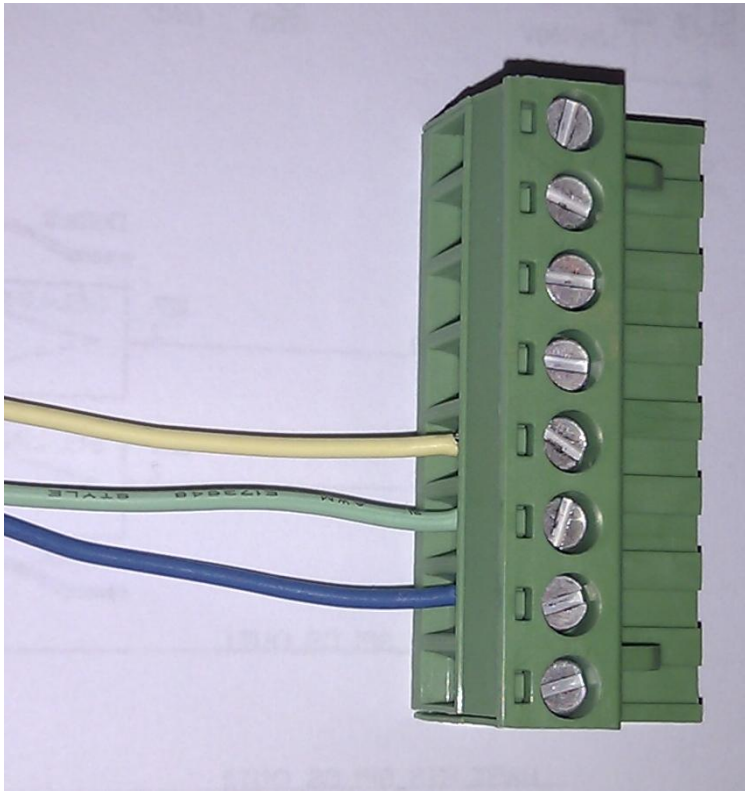

Figure 9 – BLDC motor winding cables

5.1.3 Step 3: Connect Power Supply

The *LPCXpresso Motor Control Board* must always be powered from an external power supply. The LPCXpresso LPC1549 board cannot alone power the board (even if the voltage indicator LEDs light somewhat when the board is powered only from the LPCXpresso LPC1549 board).

In included power supply has a standard 2.1mm power plug that is used to power the board. Center pin is positive. Note that the board can also be powered via the 8-pos screw connector (the same connector that the motor windings are connected to).

Verify that all three voltage indicator LEDs are on (from left to left: orange, blue, and green). Note that the LEDs are quite bright and become relatively hot.

5.1.4 Step 4: Loading the Demo Application

The demo application must be downloaded to the LPCXpresso LPC1549 board. This is a description how to download a new/updated demo application to the LPCXpresso LPC1549 board.

First make sure that the latest version of the LPCXpresso IDE is installed. The LPCXpresso LPC1549 board can be programmed standalone or inserted into the LPCXpresso Motor Control Board. If it is mounted on the latter, make sure that the external power supply is connected and supply 24V to the board.

Secondly, import the demo application project into the Eclipse workspace. The demo application can be downloaded from the product page on www.lpcware.com/motor_control.

Third, click on the "Program Flash" icon from the tool bar, see picture below. The icon can be at different places depending on window size. Also note that the exact look of the screenshots can differ slightly between different LPCXpresso IDE versions.

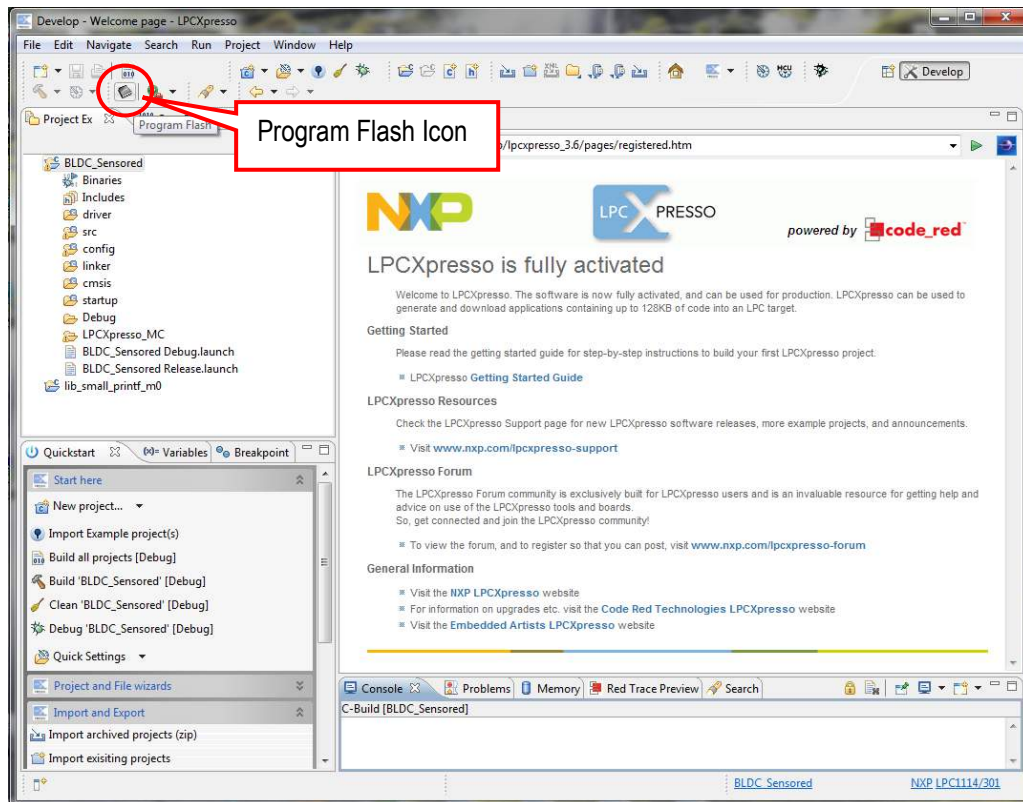

Figure 10 – LPCXpresso IDE Program Flash Icon

The next step is to select which processor to download to. Select LPC1549 from the list that is presented. Then press OK button. Note that this step is sometimes not needed because the LPCXpresso IDE can itself detect which processor it is connected to.

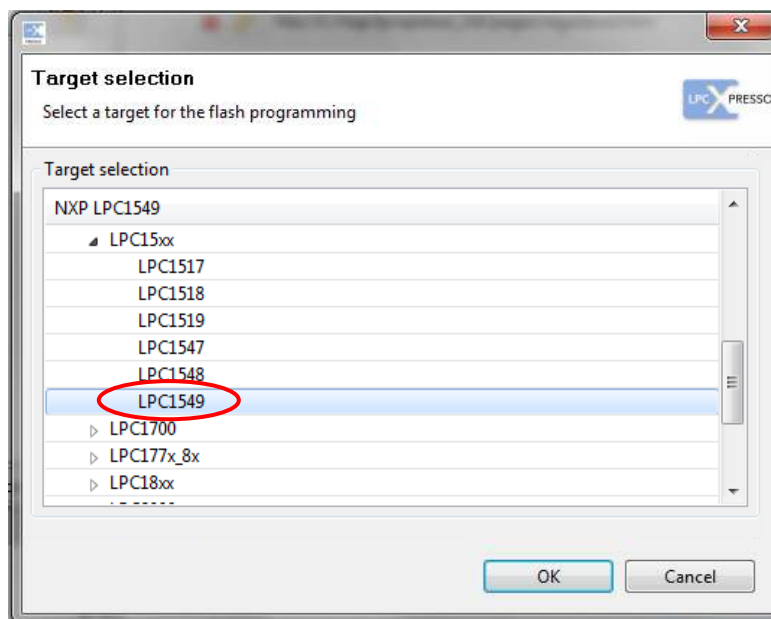

Figure 11 –LPCXpresso IDE Target Selection

The next step is to browse to the file to download. Press the “Browse” button.

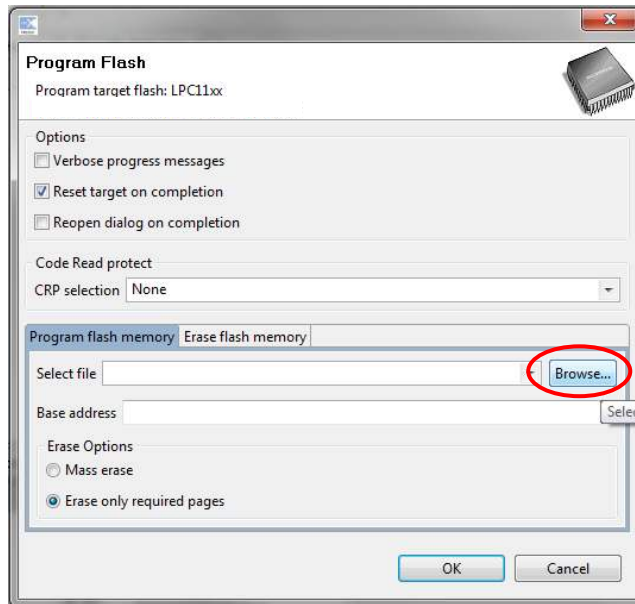

Figure 12 – LPCXpresso IDE Program Flash Window

Browse to the projects top directory and then “Debug”. In this subfolder there is either a file ending with *.axf or *.bin. Select one of these files. Press the “Open” button.

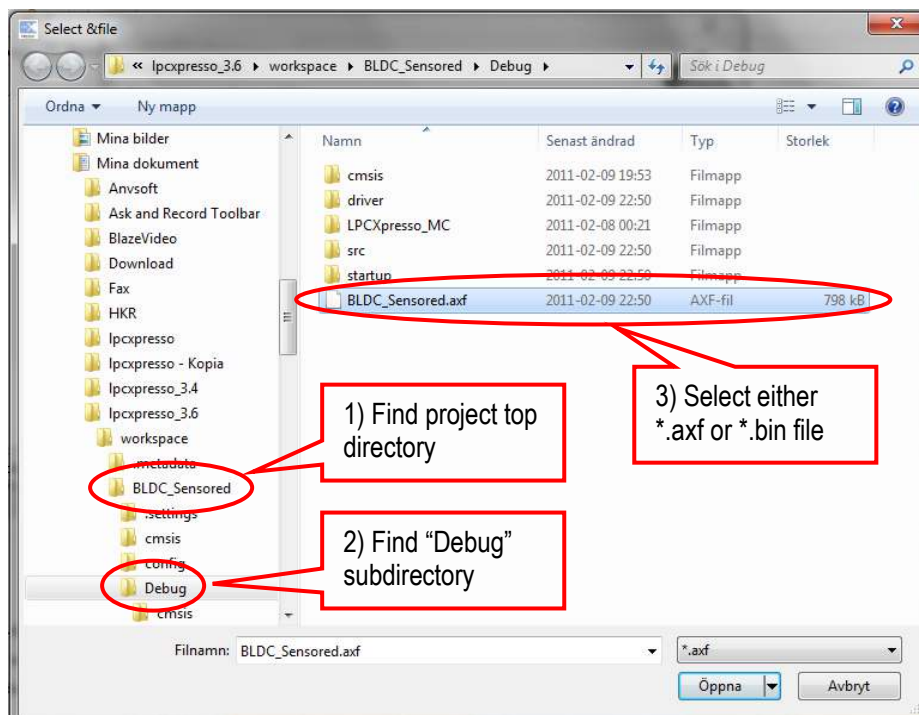

Figure 13 – Browse to File to Download

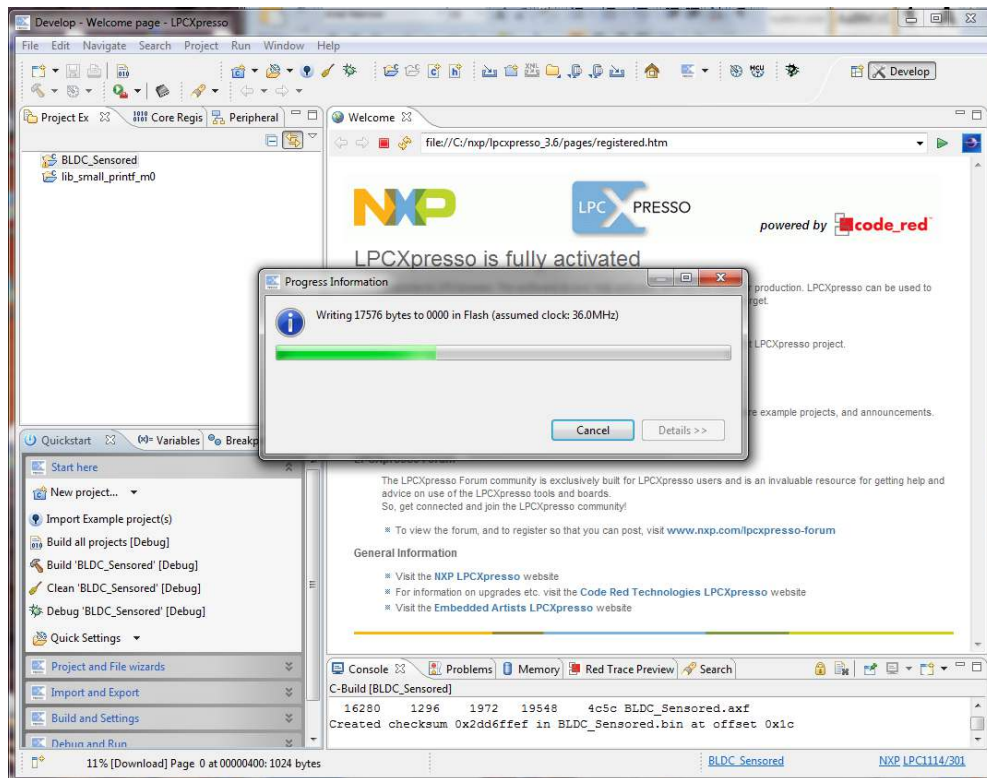

Figure 14 – LPCXpresso IDE Program Flashing in Progress

There is an alternative way of initiating the program download process. From the workspace, right click on the *.axf or *.bin file (found under the “Debug” subdirectory). Then select “Binary Utility” and “Program Flash”.

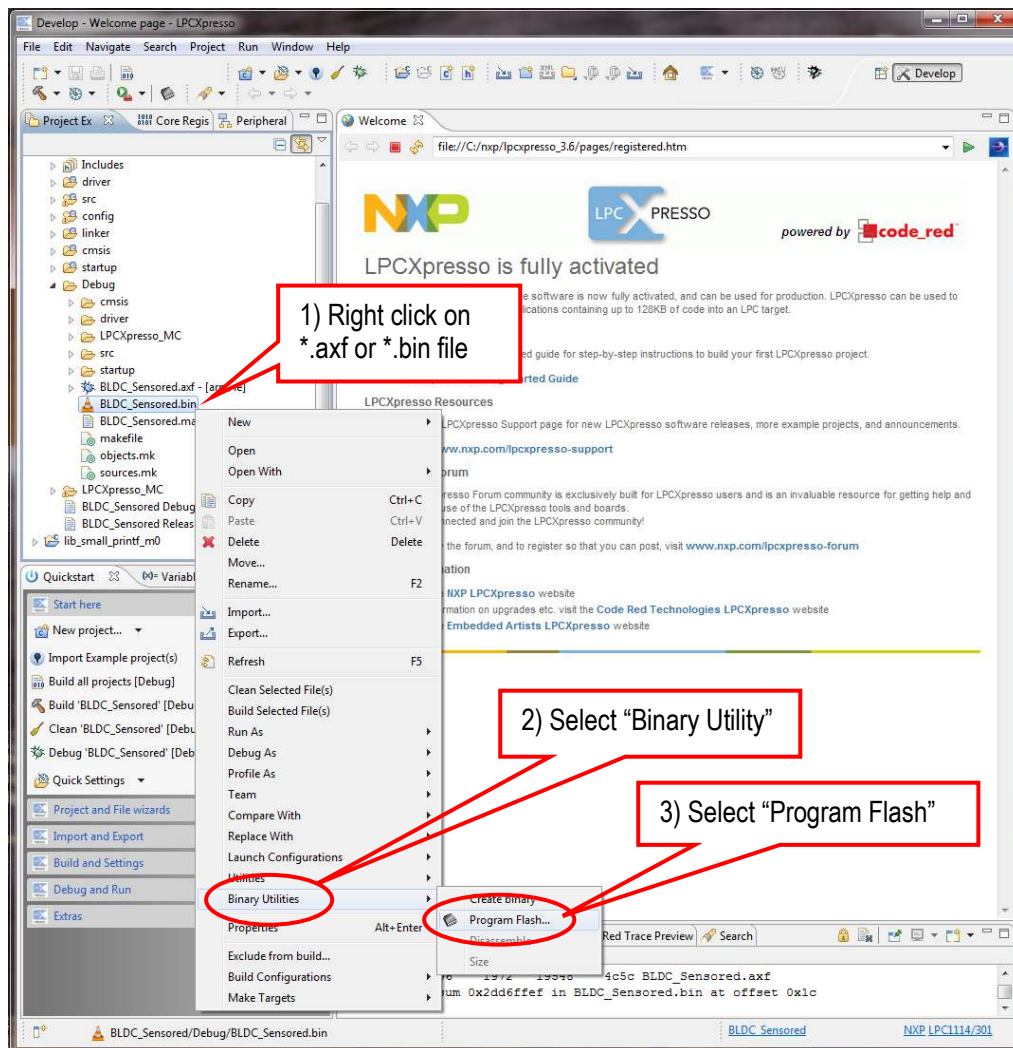

Figure 15 – LPCXpresso IDE Binary Utility

Unplug the USB cable to the LPCXpresso LPC1549 board and press the reset push-button. A startup message should be displayed on the OLED.

5.2 Installing USB Driver

The *LPCXpresso Motor Control Board* contains an USB-to-UART bridge chip (FT232R from FTDI) that connects a UART channel from the controlling MCU to a virtual COM port on the PC/laptop (via USB). This UART channel is typically used as the console channel for applications. Printf() output can for example be directed to this UART channel. The UART channel can also be used for sending motor control commands to the controlling MCU.

A USB driver must be installed on the PC/laptop in order for the virtual COM port to be created. See FTDI's installation guides for details how to install the driver for different operating systems:

<http://www.ftdichip.com/Support/Documents/InstallGuides.htm>

5.3 Demo Application

There is a demo application for the included LPCXpresso LPC1459 board. It is not pre-loaded so it has to be downloaded. See section 5.1.4 above for details how to download a new/updated demo application to the LPCXpresso LPC1549 board.

The demo application features are described on the product page: www.lpcware.com/motor_control.

5.4 Compiling the Demo Application

This section describes how to compile the demo application for the LPCXpresso LPC1549 board.

First make sure that the latest version of the LPCXpresso IDE is installed.

Secondly, import the demo application project into the Eclipse workspace. The demo application can be downloaded (as a zip-file) from the product page on www.lpcware.com/motor_control. The zip-file contains all project files and is simple way to distribute complete Eclipse projects.

Select the *Import and Export* tab in the Quickstart menu and then *Import archived projects (zip)*, see figure below.

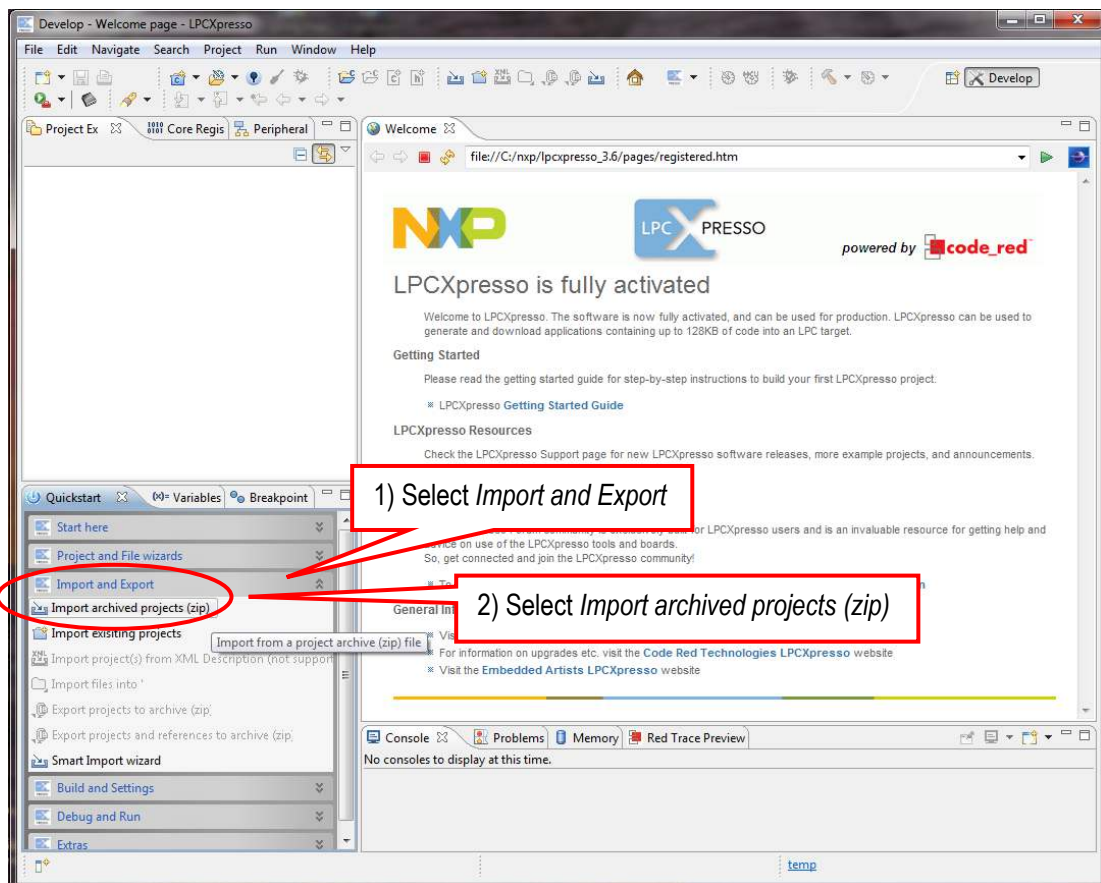

Figure 16 – LPCXpresso IDE Import Archived Project

Next, browse and select the downloaded zip file containing the archived demo application. Make sure both sub-projects are selected, see figure below.

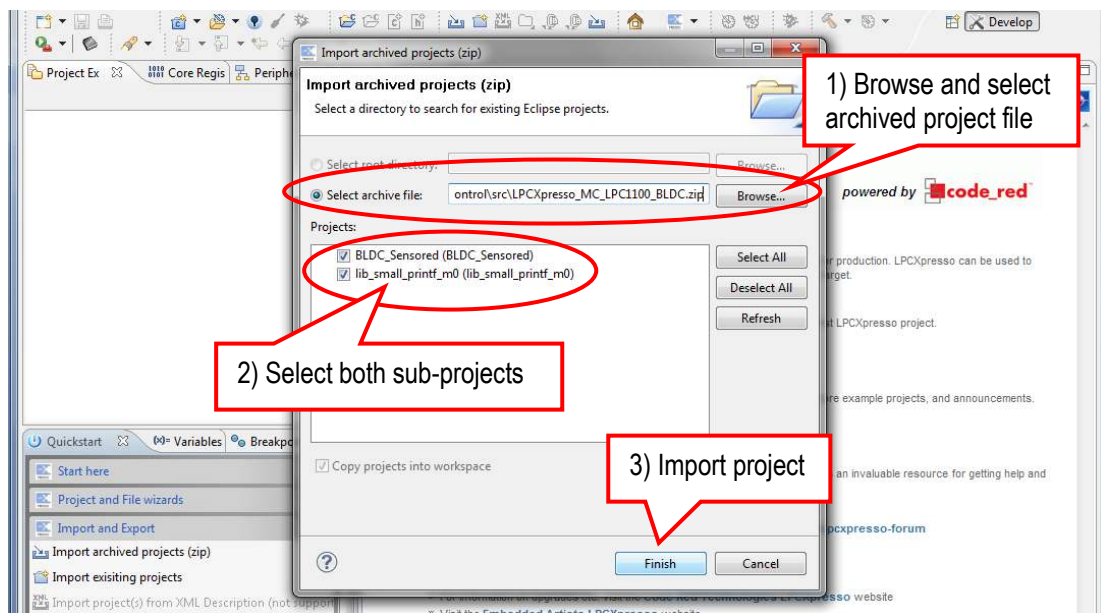

Figure 17 – LPCXpresso IDE Import Archived Project Window

The project is now imported. Click (to select) the main project. Browse and edit the project files. Build/clean/debug the project from the Quickstart menu (*Start here*), see picture below. When debugging a project, make sure the LPCXpresso LPC1549 board is connected via USB to the PC because the application will be downloaded to the board via the on-board LPC-Link2 debug interface.

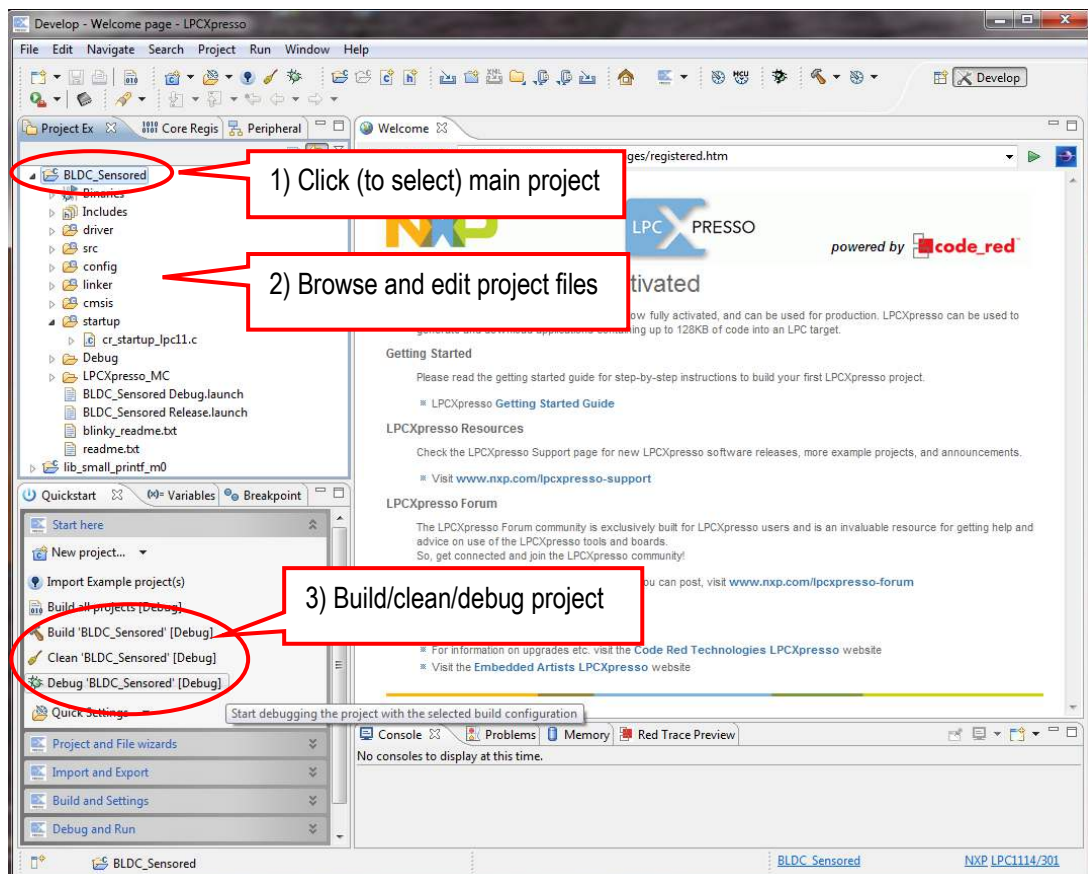

Figure 18 – LPCXpresso IDE Build/Debug Project

5.5 Things to Note/Known Issues

This section contains a couple of notes that are important to know about when working with the board.

5.5.1 Evaluation Platform – Not for End-products

The *LPCXpresso Motor Control Kit* is an evaluation platform for various motor control based on the NXP LPC-family of microcontrollers. The kit has not been designed for end-use in products. The user of the kit must be aware of the current and voltages present. It is possible to damage the *LPCXpresso Motor Control board*, the BLDC motor and the power supply if improperly used.

5.5.2 Power Supply

The included power supply is intended to for demo applications. If the BLDC motor is heavily loaded and/or used in demanding ways, the power supply might be inadequate to power the setup. In this case, use a power supply that is capable of delivering the current surges needed.

Note that the included power supply generates a considerable amount of noise when loaded. It might not be a suitable power supply when doing motor control algorithm development. The power supply is mostly for running the demonstration application.

5.5.3 Screw Connectors

The green connectors can sometimes follow/lift when the screw connector part is removed (because of the high forces involved). This does not affect functionality or reliability of the board. It is just to push back the connect housing if this occurs.

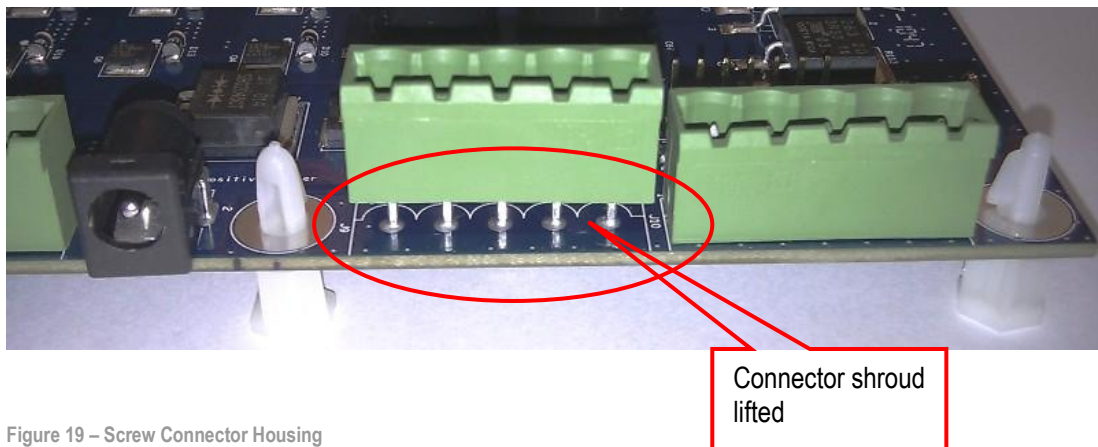

Figure 19 – Screw Connector Housing

6 Troubleshooting

This chapter contains information about how to troubleshoot boards that does not seem to operate properly. It is strongly advised to read through the list of tests and actions that can be done before contacting Embedded Artists. The different tests can help determine if there is a problem with the board, or not. For return policy, please read Embedded Artists' General Terms & Conditions document. This document can be found on the Embedded Artists' web site.

6.1 Powering

The first step is to make sure that powering works properly.

1. Remove powering to the *LPCXpresso Motor Control Board*.
2. Remove the LPCXpresso LPC1549 board and the BLDC motor connections.
3. Measure the output voltage directly from the 24V/60W power supply that is included in the kit. Do not connect the power supply to anything when measuring this. Acceptable voltage range is 23 to 26 V.
Note: before starting the measurement with a multimeter, make sure the measurement is set to voltage (as opposed to current) and that the wires to the multimeter are correctly connected. Performing a voltage measurement with a multimeter set to current measurement will short the output from the power supply and can destroy the power supply.
4. Connect the 24V/60W power supply included in the kit.
5. Measure voltages at five different positions on the board:
 - a. Measure 24V (23-26V) from power supply. Measure at J12 between VIN and GND.
 - b. Measure 24V (22-26V) after input protection diode. Measure at J12 between VBUS and GND.
 - c. Measure the +11V supply. Measure at JP6 and use JP15 as ground reference. Acceptable range for the +11.0V voltage is 10.40V to 11.60V.
 - d. Measure the +5V supply. Measure at JP6 and use JP15 as ground reference. Acceptable range for the +5.0V voltage is 4.50V to 5.50V.
 - e. Measure the +3.3V supply. Measure at JP6 and use JP15 as ground reference. Acceptable range for the +3.3V voltage is 3.15V to 3.45V.
 - f. If the reset-LED is dimming instead of being clearly on or off, it is also a sign that the supply voltages are not stable and outside of valid ranges.
If problem; since the BLDC motor is disconnected and there is no big current consumption on passive boards, it is likely that some part of the *LPCXpresso Motor Control Board* consumes a lot of current. It might be possible to locate the faulty section/component by checking component temperatures with the finger tip. Be careful because faulty components can get very hot.

The picture below illustrates where to find the different voltage measurement pads/connectors.

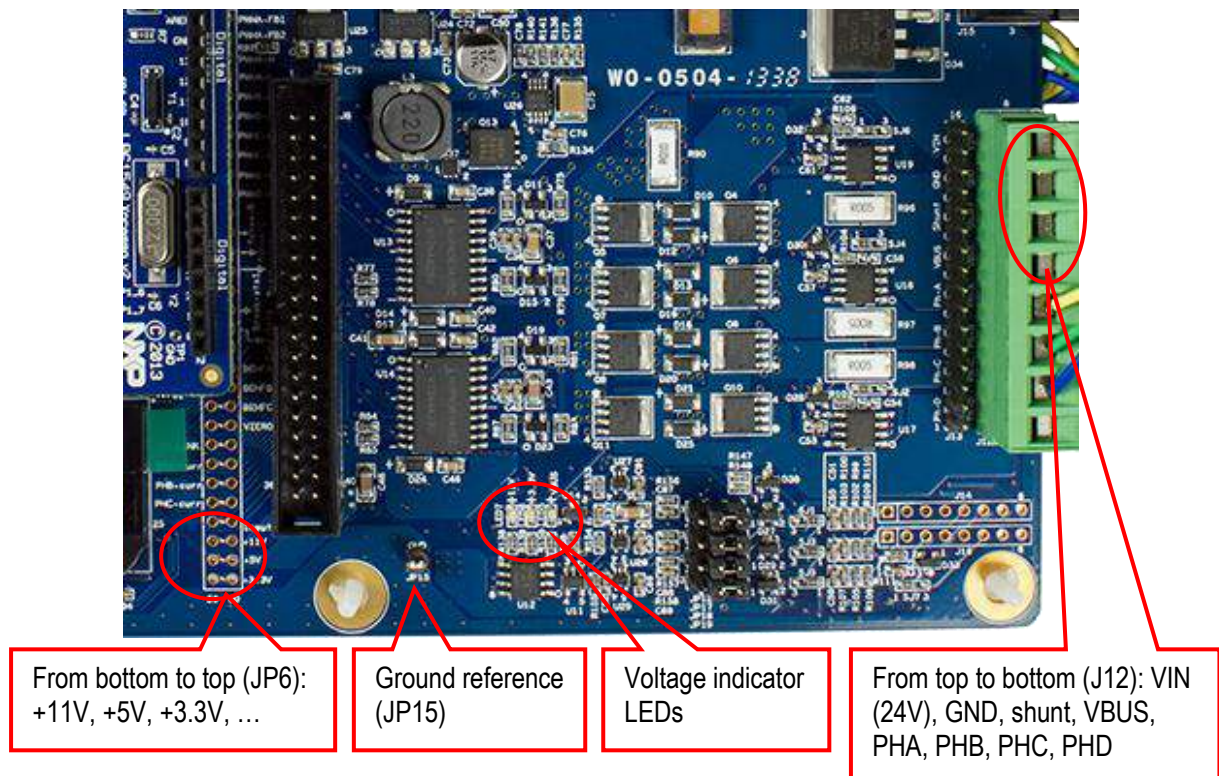

Figure 20 – Measurement Pad Locations, rev A board

- Verify that the three voltage indicator LEDs on the lower right corner of the board are all on.
- Verify that there are no voltage dips on the supply. A typical indication of this is that the reset-LED flash from time to time. It can be an indication of power supply connector wear out (the 2.1mm power jack).
- Verify that the reset-LED flash when pressing the reset push-button. The LED should also light shortly after releasing the push button. The extra “LED on time” is very short but still noticeable (typically a 1/5 of a second, i.e., 200ms).

6.2 Download Demo Application to LPCXpresso Board

Download the latest demo application into the LPCXpresso LPC1549 board. See section 5.1.4 above for details how to download a demo application to the LPCXpresso LPC1549 board.

6.3 Connect LPCXpresso Board

The second step is to make sure that the *LPCXpresso LPC1549 Board* is working when connected to the *LPCXpresso Motor Control Board*.

- Disconnect the power supply, wait 10 seconds until all voltage indicator LEDs are off. Mount the LPCXpresso LPC1549 Board on the *LPCXpresso Motor Control Board*. Make sure the LPCXpresso board is mounted in the right position. The left position is for LPCXpresso LPC1114 boards.
- Connect the 24V/60W power supply again. Measure the +5V and +3.3V voltages again (see step 5 above).
If any of the voltages are below acceptable range it is a sign of too high current consumption. It is likely that the LPCXpresso LPC1549 board is the failing part in this case.
- Verify that the reset-LED flash when pressing the reset push-button. If the reset-LED is always on when the *LPCXpresso Board* is mounted the voltage test above should likely have

failed. The LPCXpresso LPC1549 board is likely the failing part in this case. When doing this test, be sure to not have anything connected in the USB connector on the LPCXpresso board (or anything connected to the SWD/JTAG interface connector).

4. Verify that the startup message is appearing on the OLED.

6.4 Power Electronics and Motor

In this test the power electronics and the motor operation is verified.

1. Disconnect the power supply.
2. Connect the motor. Make sure cabling is correct (see correct cabling in the Getting Started Chapter in this document). Also make sure that no extra load is connected to the motor.
3. Connect the 24V/60W power supply again. Measure the +5V voltage again. If the voltage is below acceptable range it is a sign of too high current consumption in the hall sensors of the motor.
4. Verify again that the startup message is appearing on the OLED.
5. Start the motor rotation - follow the instructions in the demo application how to start the motor.

7 Further Information

The LPC1549 microcontroller is a complex circuit and there exist a number of other documents with a lot more information. The following documents are recommended as a complement to this document.

- [1] NXP LPC1549 Datasheet
<http://www.nxp.com/> TBD
- [2] NXP LPC1549 User's Manual
<http://www.nxp.com/> TBD
- [3] NXP LPC1549 Errata
<http://www.nxp.com/> TBD
- [4] ARM Processor Documentation
Documentation from ARM can be found at: <http://infocenter.arm.com/>.
- [5] Information on different ARM Architectures
<http://www.arm.com/products/processors/technologies/instruction-set-architectures.php>
- [6] ARMv6-M Architecture Reference Manual. Document identity: DDI 0419B
<http://infocenter.arm.com/help/index.jsp?topic=/com.arm.doc.ddi0419b/index.html>
- [7] LPCXpresso IDE: NXP's free/low-cost development platform for LPC families, which is an Eclipse-based IDE.
<http://www.lpcware.com/lpcxpresso/home>
- [8] LPCware website. NXP's site for the LPC series of microcontrollers.
<http://www.lpcware.com/>
- [9] LPC2000 Yahoo Group. A discussion forum dedicated entirely to the NXP LPC2xxx series of microcontrollers. This group might be more active than the LPC1000 group.
<http://tech.groups.yahoo.com/group/lpc2000/>

Note that there can be newer versions of the documents than the ones linked to here. Always check for the latest information/version.