

POWER MOS 7 FREDFET

Power MOS 7[®] is a new generation of low loss, high voltage, N-Channel enhancement mode power MOSFETS. Both conduction and switching losses are addressed with Power MOS 7[®] by significantly lowering $R_{DS(ON)}$ and Q_g . Power MOS 7[®] combines lower conduction and switching losses along with exceptionally fast switching speeds inherent with APT's patented metal gate structure.

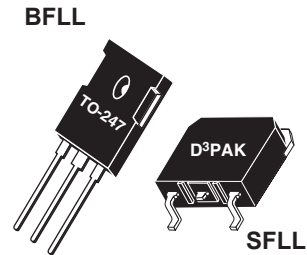

- Lower Input Capacitance
- Lower Miller Capacitance
- Lower Gate Charge, Q_g
- Increased Power Dissipation
- Easier To Drive
- TO-247 or Surface Mount D³PAK Package
- **FAST RECOVERY BODY DIODE**

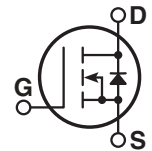

MAXIMUM RATINGS

All Ratings: $T_C = 25^\circ\text{C}$ unless otherwise specified.

| Symbol | Parameter | APT10090 | UNIT |
|----------------|--|------------|-------|
| V_{DSS} | Drain-Source Voltage | 1000 | Volts |
| I_D | Continuous Drain Current @ $T_C = 25^\circ\text{C}$ | 12 | Amps |
| I_{DM} | Pulsed Drain Current ¹ | 48 | |
| V_{GS} | Gate-Source Voltage Continuous | ±30 | Volts |
| V_{GSM} | Gate-Source Voltage Transient | ±40 | |
| P_D | Total Power Dissipation @ $T_C = 25^\circ\text{C}$ | 298 | Watts |
| | Linear Derating Factor | 2.4 | W/°C |
| T_J, T_{STG} | Operating and Storage Junction Temperature Range | -55 to 150 | °C |
| T_L | Lead Temperature: 0.063" from Case for 10 Sec. | 300 | |
| I_{AR} | Avalanche Current ¹ (Repetitive and Non-Repetitive) | 12 | Amps |
| E_{AR} | Repetitive Avalanche Energy ¹ | 30 | mJ |
| E_{AS} | Single Pulse Avalanche Energy ⁴ | 1210 | |

STATIC ELECTRICAL CHARACTERISTICS

| Symbol | Characteristic / Test Conditions | MIN | TYP | MAX | UNIT |
|--------------|--|------|-----|------|-------|
| BV_{DSS} | Drain-Source Breakdown Voltage ($V_{GS} = 0V, I_D = 250\mu\text{A}$) | 1000 | | | Volts |
| $I_{D(on)}$ | On State Drain Current ² ($V_{DS} > I_{D(on)} \times R_{DS(on)}$ Max, $V_{GS} = 10V$) | 12 | | | Amps |
| $R_{DS(on)}$ | Drain-Source On-State Resistance ² ($V_{GS} = 10V, 6A$) | | | 0.95 | Ohms |
| I_{DSS} | Zero Gate Voltage Drain Current ($V_{DS} = 1000V, V_{GS} = 0V$) | | | 250 | μA |
| | Zero Gate Voltage Drain Current ($V_{DS} = 800V, V_{GS} = 0V, T_C = 125^\circ\text{C}$) | | | 1000 | |
| I_{GSS} | Gate-Source Leakage Current ($V_{GS} = \pm 30V, V_{DS} = 0V$) | | | ±100 | nA |
| $V_{GS(th)}$ | Gate Threshold Voltage ($V_{DS} = V_{GS}, I_D = 1mA$) | 3 | | 5 | Volts |



CAUTION: These Devices are Sensitive to Electrostatic Discharge. Proper Handling Procedures Should Be Followed.

DYNAMIC CHARACTERISTICS

APT10090BFLL - SFLL

| Symbol | Characteristic | Test Conditions | MIN | TYP | MAX | UNIT |
|--------------|---------------------------------------|--|-----|------|-----|---------|
| C_{iss} | Input Capacitance | $V_{GS} = 0V$ $V_{DS} = 25V$ $f = 1\text{ MHz}$ | | 1969 | | pF |
| C_{oss} | Output Capacitance | | | 332 | | |
| C_{rss} | Reverse Transfer Capacitance | | | 55 | | |
| Q_g | Total Gate Charge ³ | $V_{GS} = 10V$ $V_{DD} = 500V$ $I_D = 12A @ 25^\circ C$ | | 71 | | nC |
| Q_{gs} | Gate-Source Charge | | | 12 | | |
| Q_{gd} | Gate-Drain ("Miller") Charge | | | 47 | | |
| $t_{d(on)}$ | Turn-on Delay Time | RESISTIVE SWITCHING $V_{GS} = 15V$ $V_{DD} = 500V$ $I_D = 12A @ 25^\circ C, R_G = 0.6\Omega$ | | 9 | | ns |
| t_r | Rise Time | | | 5 | | |
| $t_{d(off)}$ | Turn-off Delay Time | | | 23 | | |
| t_f | Fall Time | | | 4 | | |
| E_{on} | Turn-on Switching Energy ⁶ | INDUCTIVE SWITCHING @ 25°C $V_{DD} = 670V, V_{GS} = 15V$ $I_D = 12A, R_G = 5\Omega$ | | 334 | | μJ |
| E_{off} | Turn-off Switching Energy | | | 77 | | |
| E_{on} | Turn-on Switching Energy ⁶ | INDUCTIVE SWITCHING @ 125°C $V_{DD} = 670V, V_{GS} = 15V$ $I_D = 12A, R_G = 5\Omega$ | | 672 | | |
| E_{off} | Turn-off Switching Energy | | | 100 | | |

SOURCE-DRAIN DIODE RATINGS AND CHARACTERISTICS

| Symbol | Characteristic / Test Conditions | MIN | TYP | MAX | UNIT |
|-----------|--|---------------------|-----|-----|---------|
| I_S | Continuous Source Current (Body Diode) | | | 12 | Amps |
| I_{SM} | Pulsed Source Current ¹ (Body Diode) | | | 48 | |
| V_{SD} | Diode Forward Voltage ² ($V_{GS} = 0V, I_S = -I_D 12A$) | | | 1.3 | Volts |
| dv/dt | Peak Diode Recovery dv/dt ⁵ | | | 18 | V/ns |
| t_{rr} | Reverse Recovery Time ($I_S = -I_D 12A, di/dt = 100A/\mu s$) | $T_J = 25^\circ C$ | | 200 | ns |
| | | $T_J = 125^\circ C$ | | 350 | |
| Q_{rr} | Reverse Recovery Charge ($I_S = -I_D 12A, di/dt = 100A/\mu s$) | $T_J = 25^\circ C$ | | 0.7 | μC |
| | | $T_J = 125^\circ C$ | | 2.0 | |
| I_{RRM} | Peak Recovery Current ($I_S = -I_D 12A, di/dt = 100A/\mu s$) | $T_J = 25^\circ C$ | | 10 | Amps |
| | | $T_J = 125^\circ C$ | | 15 | |

THERMAL CHARACTERISTICS

| Symbol | Characteristic | MIN | TYP | MAX | UNIT |
|-----------------|---------------------|-----|-----|------|--------------|
| $R_{\theta JC}$ | Junction to Case | | | 0.42 | $^\circ C/W$ |
| $R_{\theta JA}$ | Junction to Ambient | | | 40 | |

- ① Repetitive Rating: Pulse width limited by maximum junction temperature
- ② Pulse Test: Pulse width < 380 μs , Duty Cycle < 2%
- ③ See MIL-STD-750 Method 3471

- ④ Starting $T_J = +25^\circ C, L = 16.8mH, R_G = 25\Omega, \text{Peak } I_L = 12A$
- ⑤ dv/dt numbers reflect the limitations of the test circuit rather than the device itself. $I_S \leq -I_D 12A, di/dt \leq 700A/\mu s, V_R \leq V_{DSS}, T_J \leq 150^\circ C$
- ⑥ E_{on} includes diode reverse recovery measured in accordance with JEDEC standard JESD24-1. See figures 18, 20.

APT Reserves the right to change, without notice, the specifications and information contained herein.

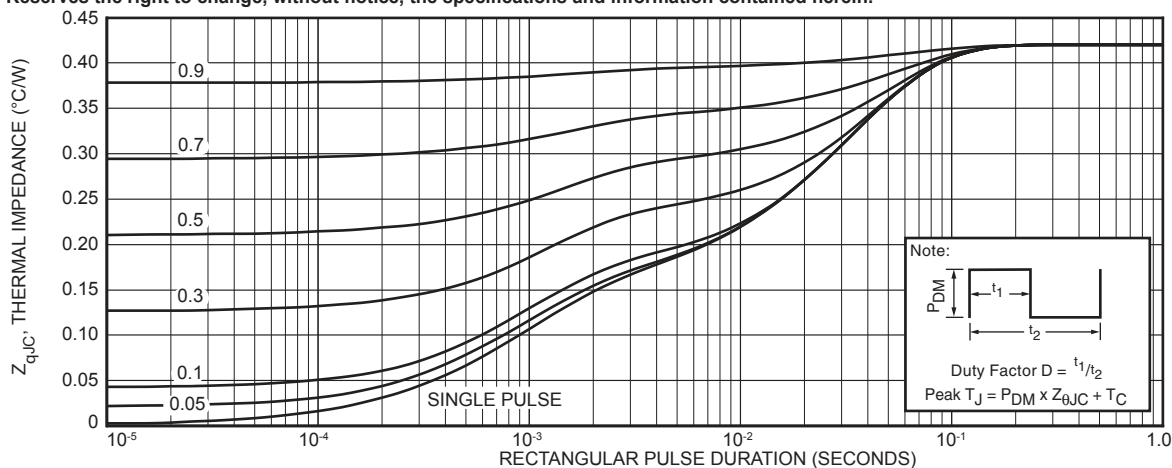

FIGURE 1, MAXIMUM EFFECTIVE TRANSIENT THERMAL IMPEDANCE, JUNCTION-TO-CASE vs PULSE DURATION

Typical Performance Curves

APT10090BFLL - SFLL

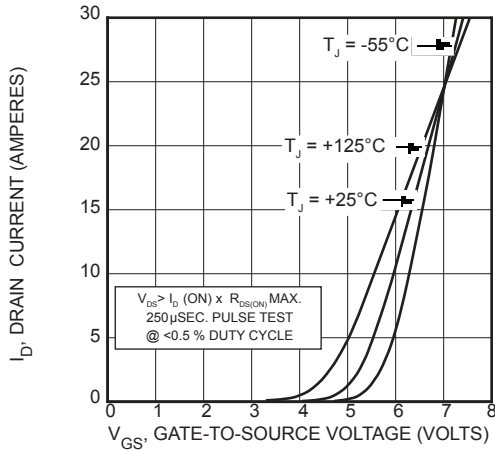

FIGURE 3, TRANSFER CHARACTERISTICS

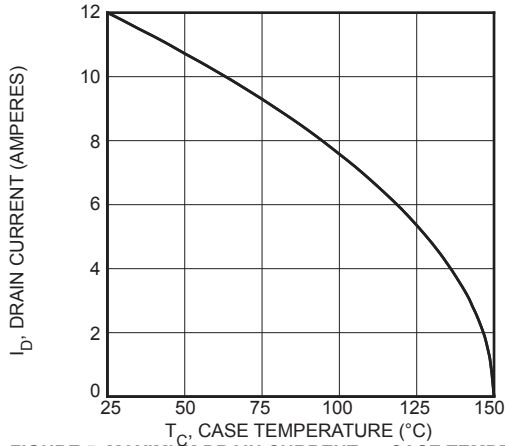

FIGURE 5, MAXIMUM DRAIN CURRENT vs CASE TEMPERATURE

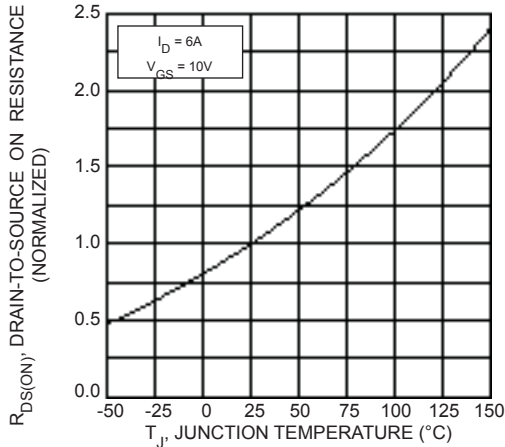

FIGURE 7, $R_{DS(ON)}$ vs. TEMPERATURE

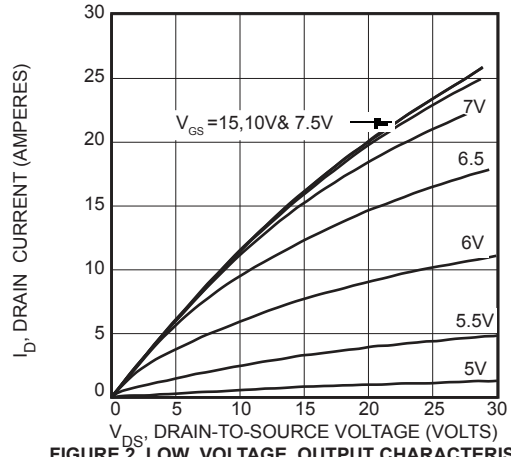

FIGURE 2, LOW VOLTAGE OUTPUT CHARACTERISTICS

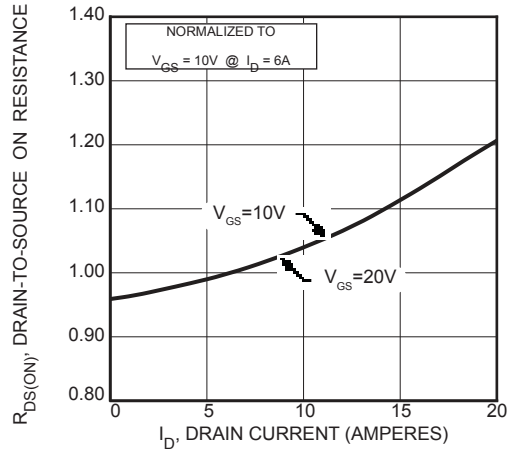

FIGURE 4, $R_{DS(ON)}$ vs DRAIN CURRENT

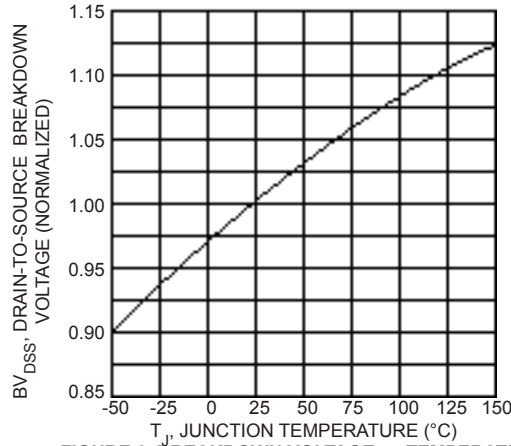

FIGURE 6, BREAKDOWN VOLTAGE vs TEMPERATURE

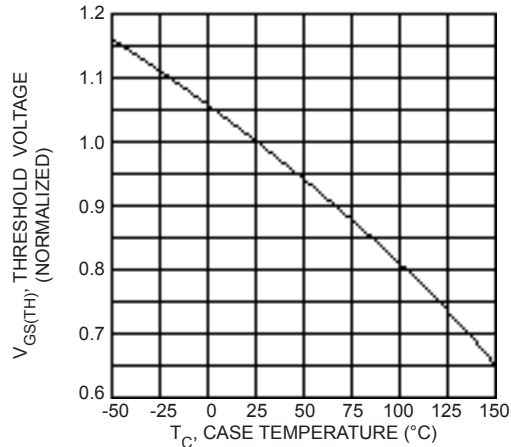

FIGURE 8, THRESHOLD VOLTAGE vs TEMPERATURE

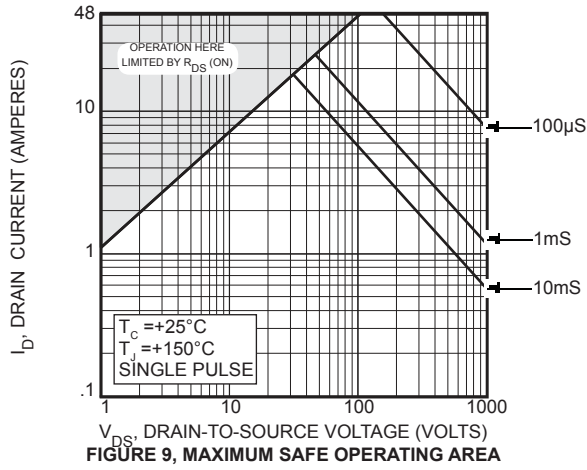

FIGURE 9, MAXIMUM SAFE OPERATING AREA

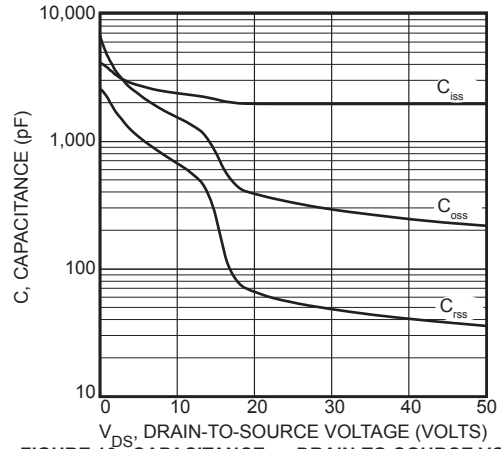

FIGURE 10, CAPACITANCE vs DRAIN-TO-SOURCE VOLTAGE

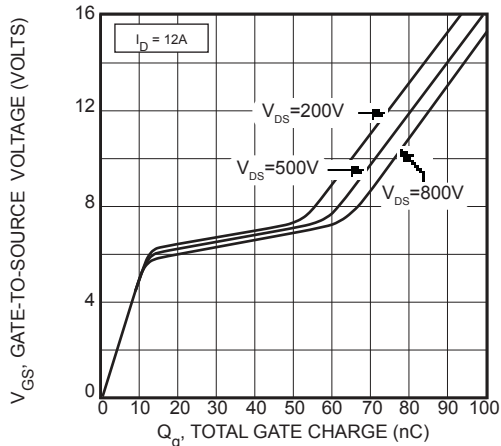

FIGURE 11, GATE CHARGE vs GATE-TO-SOURCE VOLTAGE

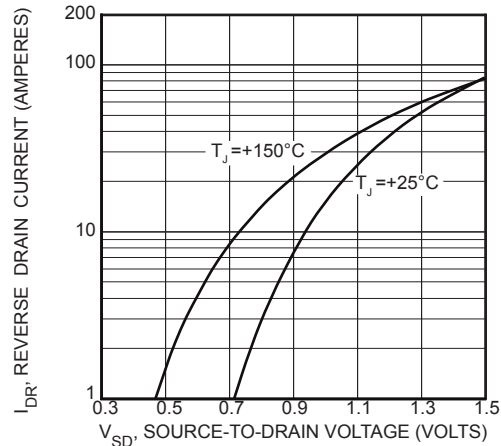

FIGURE 12, SOURCE-DRAIN DIODE FORWARD VOLTAGE

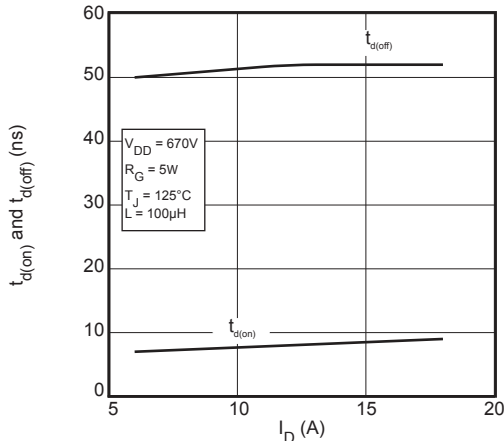

FIGURE 13, DELAY TIMES vs CURRENT

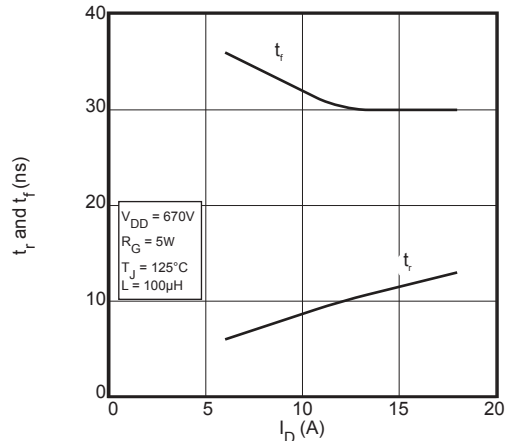

FIGURE 14, RISE AND FALL TIMES vs CURRENT

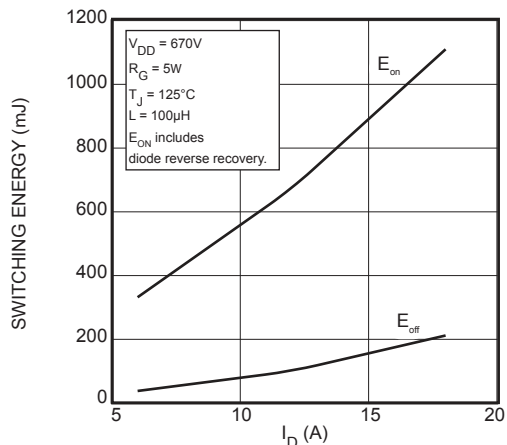

FIGURE 15, SWITCHING ENERGY vs CURRENT

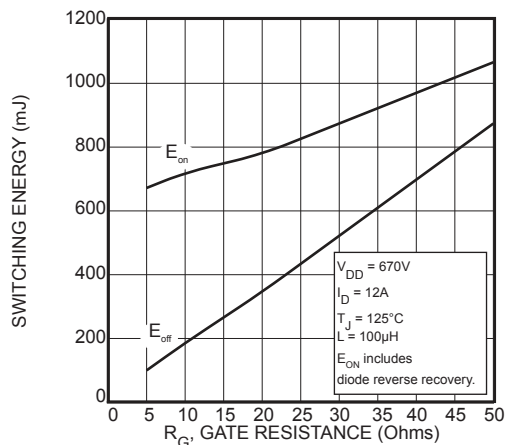

FIGURE 16, SWITCHING ENERGY vs. GATE RESISTANCE

Typical Performance Curves

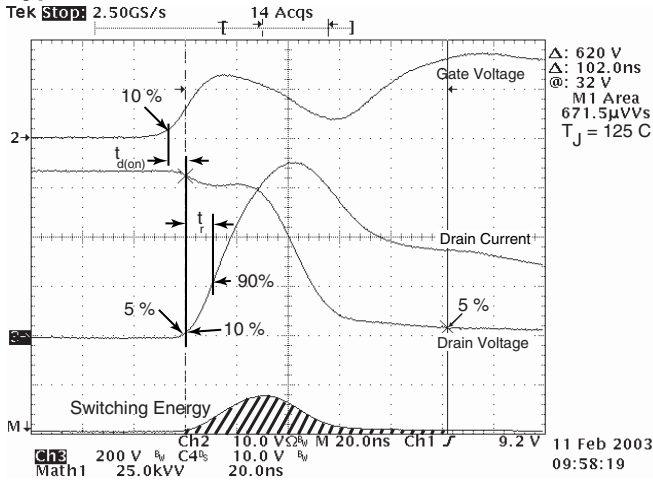

Figure 17, Turn-on Switching Waveforms and Definitions

APT10090BFL - SFLL

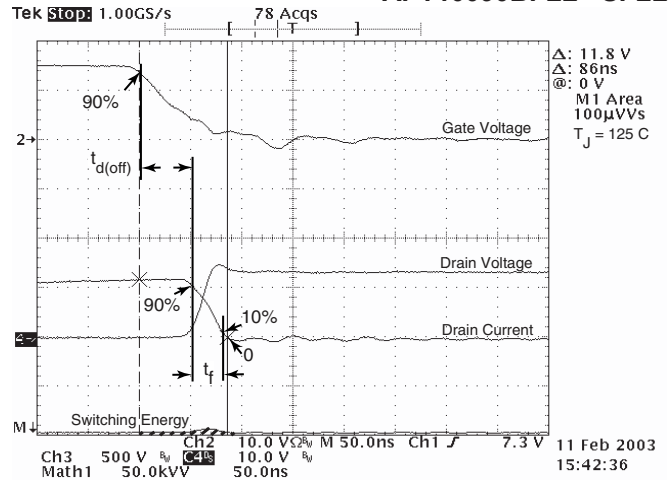

Figure 18, Turn-off Switching Waveforms and Definitions

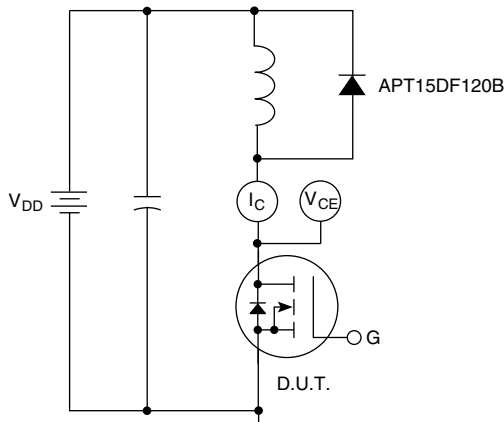
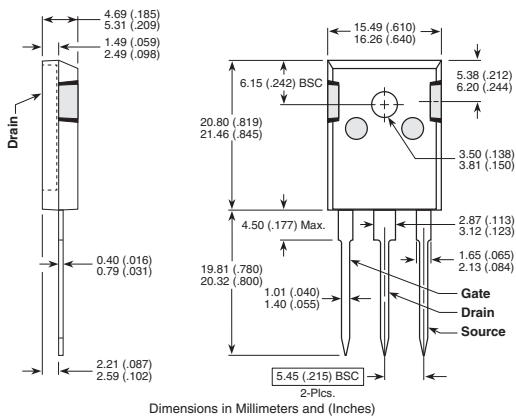
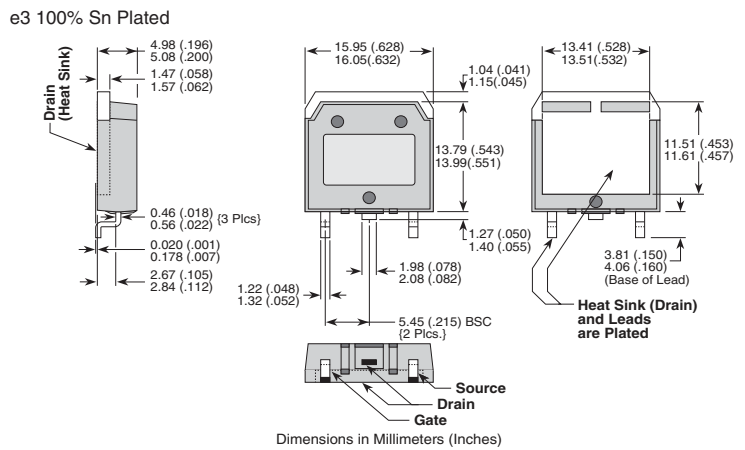

Figure 19, Inductive Switching Test Circuit

TO-247 (B) Package Outline



D³PAK Package Outline



Microsemi's products are covered by one or more of U.S. patents 4,895,810 5,045,903 5,089,434 5,182,234 5,019,522 5,262,336 6,503,786 5,256,583 4,748,103 5,283,202 5,231,474 5,434,095 5,528,058 6,939,743, 7,352,045 5,283,201 5,801,417 5,648,283 7,196,634 6,664,594 7,157,886 6,939,743 7,342,262 and foreign patents. US and Foreign patents pending. All Rights Reserved.