

1. Mechanical Dimensions:

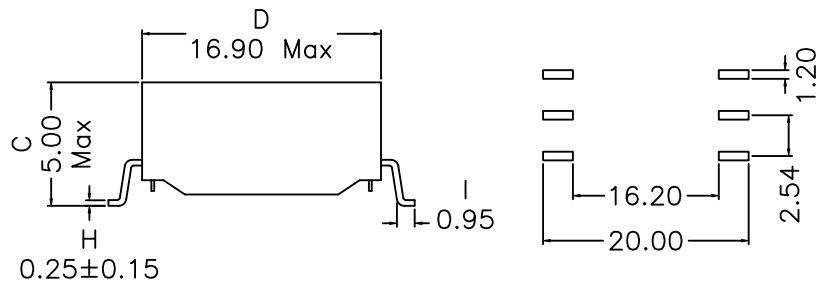

2. Schematic:

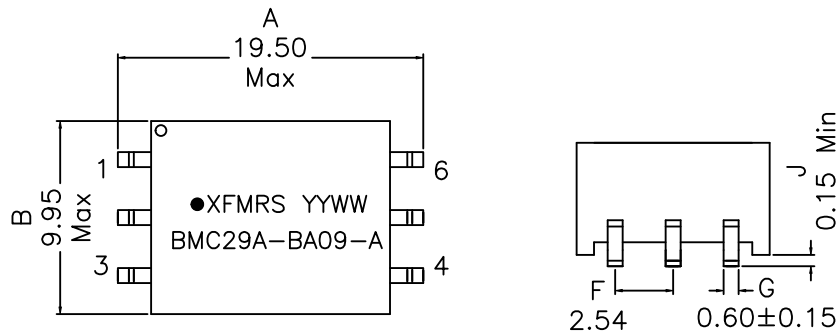
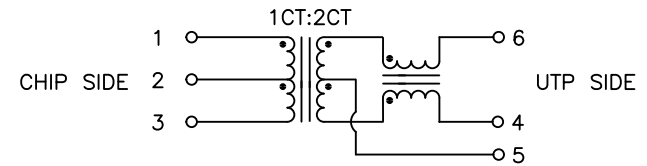

3. Electrical Specifications: @25°C

UTP Impedance: 100 OHMS

Turns Ratio: (CHIP : UTP)=1CT:2CT±2%

Isolation Voltage: 2900Vac, CHIP SIDE to UTP SIDE

CHIP Side OCL: 350uH Min @100KHz 0.1V, 8mAdc

CHIP Side Q: 5 Min @100KHz 0.1V,

Rise Time (10-90%): 4.0ns Typical

Insertion Loss (1-50MHz): -2.2dB Maximum

(50-100MHz): -10.0dB Maximum

Return Loss: 30MHz 60MHz 80MHz

-15dB -5dB -2dB Typ

CMRR: 30MHz 50MHz 100MHz

-36dB -30dB -25dB TYP

Notes:

- Solderability: Leads shall meet MIL-STD-202G, Method 208H for solderability.
- Flammability: UL94V-0
- ASTM oxygen index: > 28%
- Insulation System: Class F 155°C, UL file E151556
- Operating Temperature Range: -40°C to +125°C
- Storage Temperature Range: -55°C to +125°C
- Aqueous wash compatible
- SMD Lead Coplanarity: ±0.004"(0.102mm)
- Electrical and mechanical specifications 100% tested
- RoHS Compliant Component
- Recommended IR Reflow peak temp of 250°C Max.

DOC. REV: A/4

XFMRS® www.XFMRS.com	Title: TRANSFORMER		
	UNLESS OTHERWISE SPECIFIED	P/N: XFBMC29A-BA09-A	REV. A
TOLERANCES: .xx ±0.25	DWN.	Yu	Aug-06-20
Dimensions in MM	CHK.	YK Liao	Aug-06-20
SHEET 1 OF 1	APP.	DDC	Aug-06-20

CONCEPT

GENERAL INFORMATION

Part Number:	95-BMC0-29-XH
Part Description:	TRANSFORMER
Weight (lbs.):	0.00210 lbs.approx
T&R Notes:	1) PROCESS IN ACCORDANCE WITH EIA-461-2 STANDARDS * TAPE LEADER DIMENSION 15.30" MIN. * TAPE TRAILER DIMENSION 6.30" MIN. 2) PARTS SHOULD BE PACKAGED IN ACCORDANCE WITH ESD GUIDELINES IN EIA-541. 3) REEL LABEL: 'A' * PART NUMBER * QUANTITY * DATE CODE

SUPPLIER INFORMATION

Company Name:	XFMR
Address Line 1:	UNIT G-J, 3/F, BLK 1, GOLDEN DRAGON IND CTR
State / ZIP:	152-160 TAI LIN PAI ROAD
Country:	HONG KONG, CHINA
Program Manager:	Kitty Lai
Contact E-mail:	klai@xfmrs.com.hk
Contact Phone:	852 2423 1689

PRIMARY PACKAGING

Packaging Type:	PST&R			
Dimensions(cm):	L 33.0	W 33.0	H 3.2	
Weight:	1.08 lbs. approx			
QPC (Parts Per Reel)	650 pcs.			
Total Weight w/parts:	2.44 lbs.			
Banding / Shrink / Wrap:	BOPP Wrap			
Other:	N/A			

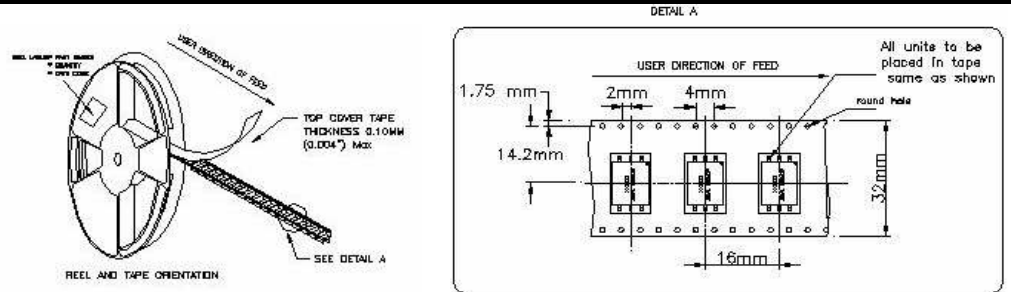

SECONDARY PACKAGING

Packaging Type:	Paper Box			
Dimensions(cm):	L 36.5	W 36.5	H 36.0	
Weight:	1.89 lbs.			
Boxes per Unit Load:	5200 pcs.			
Total weight w/Parts (lbs):	21.94 lbs.approx			
Banding / Shrink / Wrap:	BOPP Wrap / PP Banding			
Other:	N/A			

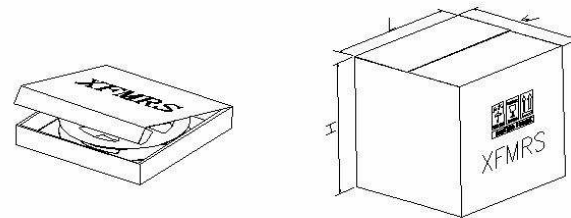

SHIPPING INFORMATION

Packaging Type:	PE Pallet			
Unit Load dims(cm):	L 120	W 100	H 161	
Weight:	16.72 lbs.			
Number of box Loads:	24 box.			
Number of Parts:	124800 pcs.			
Load weight total (lbs):	543.18 lbs.approx			
Banding / Shrink / Wrap:	PE Shrink			

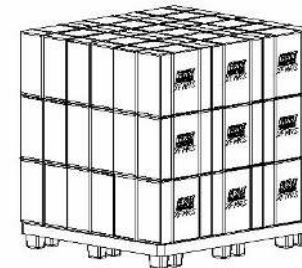

PACKAGING APPROVAL

Internal Document
 Manufacture / Q.A. / Process Instructions

Drafted	Checked	Approved	Rev	Date
Kong	Liao		A/1	Aug-07-20

XFMRs

Recommended Infrared Reflow Temperature Profile for Select Parts

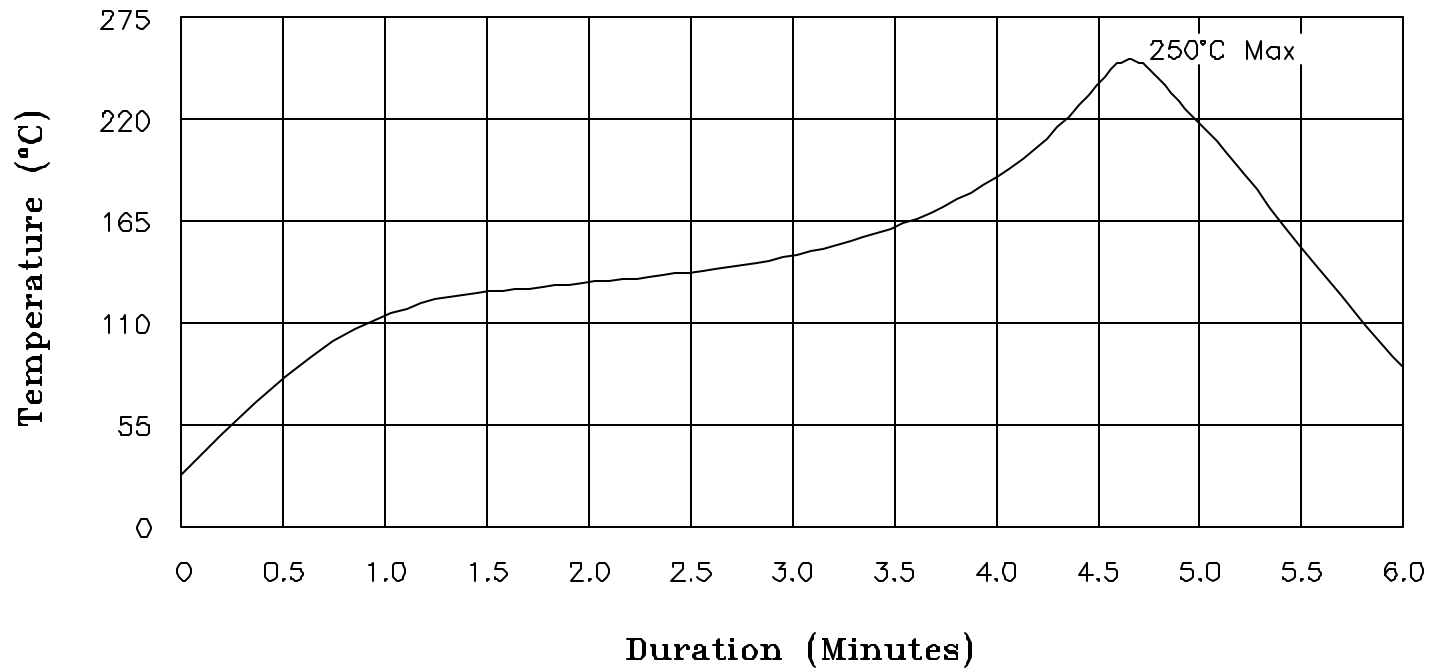

NOTES: Maximum duration at 250°+0/-5° shall be 10-15 seconds.
 Maximum duration above 217° shall be 50-120 seconds.
 ALL Temperatures refer to topside of the package, measured on the package body surface.

XFMRs Inc www.XFMRs.com	Title: IR REFLOW CHART (250°C)			
	UNLESS OTHERWISE SPECIFIED TOLERANCES: N/A		P/N: N/A	REV. A
	DWN.	Juan Mao	Dec-20-06	
	CHK.	YK Liao	Dec-20-06	
SHEET 1 OF 1	APP.	Joe Huff	Dec-20-06	