

# PTPOWER 185 F - High-current terminal block



1054732

<https://www.phoenixcontact.com/us/products/1054732>

Please be informed that the data shown in this PDF document is generated from our online catalog. Please find the complete data in the user documentation. Our general terms of use for downloads are valid.



High-current terminal block, nom. voltage: 1000 V, nominal current: 309 A, number of connections: 2, number of positions: 1, connection method: PowerTurn connection, 1 level, cross section: 95 mm<sup>2</sup> - 185 mm<sup>2</sup>, mounting type: direct screw connection, color: gray

## Your advantages

- Quick and easy connection is now also possible for large conductors with the high-current terminal block
- The compact design enables wiring in a confined space
- In addition to using the existing test connection, pick-off terminal blocks can be connected, each of which can also accommodate two test cables

## Commercial data

Item number	1054732
Packing unit	1 pc
Minimum order quantity	3 pc
Sales key	BE22
Product key	BE2211
Catalog page	Page 141 (C-1-2019)
GTIN	4055626690865
Weight per piece (including packing)	373.53 g
Weight per piece (excluding packing)	349.3 g
Customs tariff number	85369010
Country of origin	PL

# PTPOWER 185 F - High-current terminal block



1054732

<https://www.phoenixcontact.com/us/products/1054732>

## Technical data

### Product properties

Product type	High current terminal block
Number of positions	1
Pitch	31 mm
Number of connections	2
Number of rows	1
Potentials	1

### Insulation characteristics

Overvoltage category	III
Degree of pollution	3

### Electrical properties

Rated surge voltage	8 kV
Maximum power dissipation for nominal condition	9.55 W

### Connection data

Number of connections per level	2
Nominal cross section	150 mm <sup>2</sup>

#### 1 level

Stripping length	40 mm
Internal cylindrical gage	B14
Connection in acc. with standard	IEC 60947-7-1
Conductor cross section rigid	95 mm <sup>2</sup> ... 185 mm <sup>2</sup>
Cross section AWG	3/0 ... 350 kcmil (converted acc. to IEC)
Conductor cross section flexible	95 mm <sup>2</sup> ... 185 mm <sup>2</sup>
Conductor cross section, flexible [AWG]	3/0 ... 350 kcmil (converted acc. to IEC)
Conductor cross-section flexible (ferrule without plastic sleeve)	95 mm <sup>2</sup> ... 150 mm <sup>2</sup>
Flexible conductor cross section (ferrule with plastic sleeve)	95 mm <sup>2</sup> ... 150 mm <sup>2</sup>
Cross-section with insertion bridge, rigid	95 mm <sup>2</sup> ... 150 mm <sup>2</sup>
Cross-section with insertion bridge, flexible	95 mm <sup>2</sup> ... 150 mm <sup>2</sup>
Cross-section with insertion bridge, flexible, with ferrule without plastic sleeve	95 mm <sup>2</sup> ... 120 mm <sup>2</sup>
Cross-section with insertion bridge, flexible, with ferrule with plastic sleeve	95 mm <sup>2</sup> ... 120 mm <sup>2</sup>
Nominal current	309 A
Maximum load current	309 A (with 150 mm <sup>2</sup> conductor cross section)
Nominal voltage	1000 V

#### 1 level Connection cross sections directly pluggable

Conductor cross section rigid	95 mm <sup>2</sup> ... 185 mm <sup>2</sup>
Conductor cross-section flexible (ferrule without plastic sleeve)	95 mm <sup>2</sup> ... 150 mm <sup>2</sup>

# PTPOWER 185 F - High-current terminal block



1054732

<https://www.phoenixcontact.com/us/products/1054732>

Flexible conductor cross section (ferrule with plastic sleeve)	95 mm <sup>2</sup> ... 150 mm <sup>2</sup>
--	--

## Dimensions

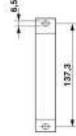
Dimensional drawing	
Width	31 mm
Height	150 mm
Depth	108.3 mm
Drill hole spacing	137.2 mm
Hole diameter	6.5 mm
Pitch	31 mm

## Material specifications

Color	gray
Flammability rating according to UL 94	V0
Insulating material group	I
Insulating material	PA

## Mechanical properties

Mechanical data	
Open side panel	No
Technical data	
Drill hole spacing	137.2 mm

## Environmental and real-life conditions

Ambient conditions	
Ambient temperature (operation)	-60 °C ... 105 °C (max. short-term operating temperature RTI Elec.)
Ambient temperature (storage/transport)	-25 °C ... 60 °C (for a short time, not exceeding 24 h, -60 °C to +70 °C)
Ambient temperature (assembly)	-5 °C ... 70 °C
Ambient temperature (actuation)	-5 °C ... 70 °C
Permissible humidity (storage/transport)	30 % ... 70 %

## Standards and regulations

Connection in acc. with standard	IEC 60947-7-1
----------------------------------	---------------

## Mounting

Mounting type	direct screw connection
---------------	-------------------------

# PPOWER 185 F - High-current terminal block

1054732

<https://www.phoenixcontact.com/us/products/1054732>



## Drawings

### Circuit diagram



# PTPOWER 185 F - High-current terminal block

1054732

<https://www.phoenixcontact.com/us/products/1054732>



Schematic diagram

## PTPOWER



AGK 10-PTPOWER	0,5 mm <sup>2</sup> ... 16 mm <sup>2</sup>	18 mm
PTPOWER 35	2,5 mm <sup>2</sup> ... 35 mm <sup>2</sup>	25 mm
PTPOWER 50	10 mm <sup>2</sup> ... 50 mm <sup>2</sup>	32 mm
PTPOWER 95	25 mm <sup>2</sup> ... 95 mm <sup>2</sup>	40 mm
PTPOWER 185	95 mm <sup>2</sup> ... 185 mm <sup>2</sup>	40 mm

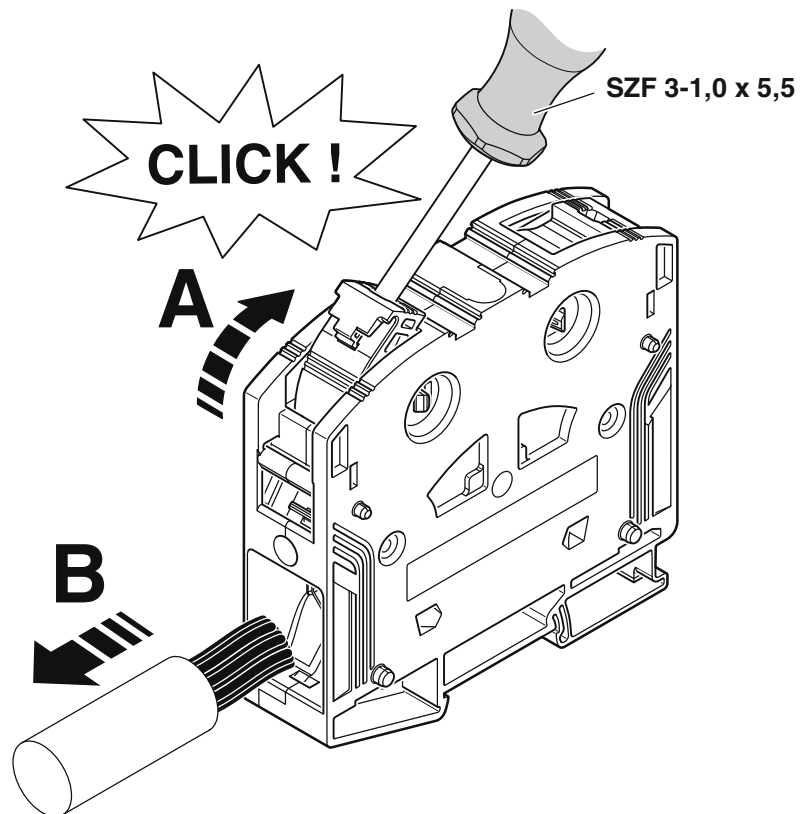

# PPOWER 185 F - High-current terminal block

1054732

<https://www.phoenixcontact.com/us/products/1054732>



Dimensional drawing

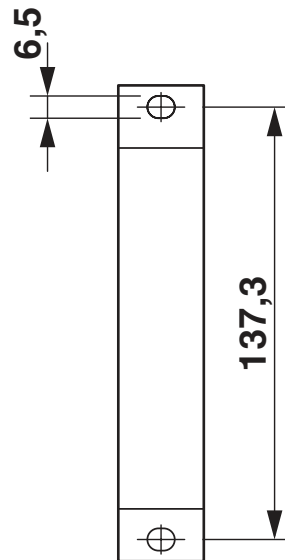

# PTPOWER 185 F - High-current terminal block





1054732

<https://www.phoenixcontact.com/us/products/1054732>

## Approvals

To download certificates, visit the product detail page: <https://www.phoenixcontact.com/us/products/1054732>

 <b>UL Recognized</b> Approval ID: E60425				
	Nominal voltage $U_N$	Nominal current $I_N$	Cross section AWG	Cross section $\text{mm}^2$
Use group F	1000 V	290 A	3/0 - 350	-
Use group E	1000 V	290 A	3/0 - 350	-

 <b>EAC</b> Approval ID: RU C-DE.BL08.B.00644				
---	--	--	--	--

 <b>DNV</b> Approval ID: TAE00000Z9				
---	--	--	--	--

# PTPOWER 185 F - High-current terminal block



1054732

<https://www.phoenixcontact.com/us/products/1054732>

## Classifications

### ECLASS

ECLASS-11.0	27141120
ECLASS-13.0	27250101

### ETIM

ETIM 8.0	EC000897
----------	----------

### UNSPSC

UNSPSC 21.0	39121400
-------------	----------



# PTPOWER 185 F - High-current terminal block



1054732

<https://www.phoenixcontact.com/us/products/1054732>

## Environmental product compliance

China RoHS	Environmentally friendly use period: unlimited = EFUP-e No hazardous substances above threshold values
------------	---

# PTPOWER 185 F - High-current terminal block



1054732

<https://www.phoenixcontact.com/us/products/1054732>

## Accessories

**i** Note: Applying some accessories below might limit this product.

### EB 2-31/PT - Insertion bridge

3215057

<https://www.phoenixcontact.com/us/products/3215057>

Insertion bridge, pitch: 31 mm, number of positions: 2, length: 78 mm, color: red



**i** Max. current carrying capacity: 232 A

---

### EB 3-31/PT - Insertion bridge

3215058

<https://www.phoenixcontact.com/us/products/3215058>

Insertion bridge, pitch: 31 mm, number of positions: 3, length: 78 mm, color: red



**i** Max. current carrying capacity: 232 A

# PTPOWER 185 F - High-current terminal block



1054732

<https://www.phoenixcontact.com/us/products/1054732>

## AGK 10-PTPOWER - Pick-off terminal

3260145

<https://www.phoenixcontact.com/us/products/3260145>



Pick-off terminal, nom. voltage: 1500 V, nominal current: 57 A, number of connections: 2, connection method: Push-in connection, 1 level, Rated cross section: 10 mm<sup>2</sup>, cross section: 0.5 mm<sup>2</sup> - 16 mm<sup>2</sup>, mounting type: on base element, color: gray

---

## AGK 10-PTPOWER BU - Pick-off terminal

3260148

<https://www.phoenixcontact.com/us/products/3260148>



Pick-off terminal, nom. voltage: 1500 V, nominal current: 57 A, number of connections: 2, connection method: Push-in connection, 1 level, Rated cross section: 10 mm<sup>2</sup>, cross section: 0.5 mm<sup>2</sup> - 16 mm<sup>2</sup>, mounting type: on base element, color: blue

# PTPOWER 185 F - High-current terminal block



1054732

<https://www.phoenixcontact.com/us/products/1054732>

## AGK 10-PTPOWER GN/YE - Pick-off terminal

3260151

<https://www.phoenixcontact.com/us/products/3260151>

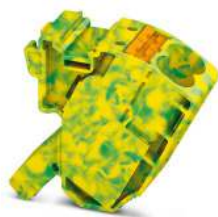

Pick-off terminal, nom. voltage: 1500 V, nominal current: 57 A, number of connections: 2, connection method: Push-in connection, 1 level, Rated cross section: 10 mm<sup>2</sup>, cross section: 0.5 mm<sup>2</sup> - 16 mm<sup>2</sup>, mounting type: on base element, color: green/yellow

---

## AGK 10-PTPOWER BK/YE - Pick-off terminal

3260154

<https://www.phoenixcontact.com/us/products/3260154>



Pick-off terminal, nom. voltage: 1500 V, nominal current: 57 A, number of connections: 2, connection method: Push-in connection, 1 level, Rated cross section: 10 mm<sup>2</sup>, cross section: 0.5 mm<sup>2</sup> - 16 mm<sup>2</sup>, mounting type: on base element, color: black/yellow

# PTPOWER 185 F - High-current terminal block



1054732

<https://www.phoenixcontact.com/us/products/1054732>

## SZF 3-1,0X5,5 - Screwdriver

1206612

<https://www.phoenixcontact.com/us/products/1206612>



Actuation tool, for ST terminal blocks, also suitable for use as a bladed screwdriver, size: 1.0 x 5.5 x 150 mm, 2-component grip, with non-slip grip

---

## CEC PTPOWER 95/185 - Cover

1056087

<https://www.phoenixcontact.com/us/products/1056087>



Cover, yellow, labeled: Lightning flash, mounting type: plug in

# PTPOWER 185 F - High-current terminal block

1054732

<https://www.phoenixcontact.com/us/products/1054732>



## PTPOWER-IL - Mounting material

1180891

<https://www.phoenixcontact.com/us/products/1180891>

Operating decal for the PTPOWER



---

## SZS 0,8X4,0 VDE - Screwdriver

1212508

<https://www.phoenixcontact.com/us/products/1212508>

Screwdriver, slot-headed, VDE insulated, size: 0.8 x 4.0 x 100 mm, 2-component grip, with non-slip grip



# PTPOWER 185 F - High-current terminal block



1054732

<https://www.phoenixcontact.com/us/products/1054732>

## SZK PZ2 VDE - Screwdriver

1206463

<https://www.phoenixcontact.com/us/products/1206463>



Screwdriver, PZ crosshead, VDE insulated, size: PZ 2 x 100 mm, 2-component grip, with non-slip grip

---

## SF-PH 2-100 S-VDE - Screwdriver

1212694

<https://www.phoenixcontact.com/us/products/1212694>



Screwdriver, crosshead PH (lasered), insulated, size: PH 2 x 100, 2-component handle, with non-slip grip

# PTPOWER 185 F - High-current terminal block



1054732

<https://www.phoenixcontact.com/us/products/1054732>

## NS 35/15 PERF 2000MM - DIN rail perforated

1201730

<https://www.phoenixcontact.com/us/products/1201730>



DIN rail perforated, similar to EN 60715, material: Steel, galvanized, passivated with a thick layer, Standard profile, color: silver, Pack of 25 (50 m)

---

## NS 35/15 UNPERF 2000MM - DIN rail, unperforated

1201714

<https://www.phoenixcontact.com/us/products/1201714>



DIN rail, unperforated, similar to EN 60715, material: Steel, galvanized, passivated with a thick layer, Standard profile, color: silver, Pack of 25 (50 m)



# PTPOWER 185 F - High-current terminal block



1054732

<https://www.phoenixcontact.com/us/products/1054732>

## NS 35/15 WH PERF 2000MM - DIN rail perforated

0806602

<https://www.phoenixcontact.com/us/products/0806602>



DIN rail perforated, similar to EN 60715, material: Steel, Galvanized, white passivated, Standard profile, color: white, Pack of 25 (50 m)

---

## NS 35/15 WH UNPERF 2000MM-VPE 10 - DIN rail, unperforated

1204135

<https://www.phoenixcontact.com/us/products/1204135>



DIN rail, unperforated, similar to EN 60715, material: Steel, Galvanized, white passivated, Standard profile, color: silver, Pack of 10 (20 m)

# PTPOWER 185 F - High-current terminal block



1054732

<https://www.phoenixcontact.com/us/products/1054732>

## NS 35/15 AL UNPERF 2000MM - DIN rail, unperforated

1201756

<https://www.phoenixcontact.com/us/products/1201756>



DIN rail, unperforated, similar to EN 60715, material: Aluminum, uncoated, Standard profile, color: silver

---

## NS 35/15 ZN PERF 2000MM - DIN rail perforated

1206599

<https://www.phoenixcontact.com/us/products/1206599>



DIN rail perforated, similar to EN 60715, material: Steel, galvanized, Standard profile, color: silver, Pack of 25 (50 m)

# PTPOWER 185 F - High-current terminal block



1054732

<https://www.phoenixcontact.com/us/products/1054732>

## NS 35/15 ZN UNPERF 2000MM - DIN rail, unperforated

1206586

<https://www.phoenixcontact.com/us/products/1206586>



DIN rail, unperforated, similar to EN 60715, material: Steel, galvanized, Standard profile, color: silver, Pack of 25 (50 m)

---

## NS 35/15 CU UNPERF 2000MM-VPE 10 - DIN rail, unperforated

1201895

<https://www.phoenixcontact.com/us/products/1201895>



DIN rail, unperforated, similar to EN 60715, material: Copper, uncoated, Standard profile, color: copper-colored, Pack of 10 (20 m)

# PTPOWER 185 F - High-current terminal block



1054732

<https://www.phoenixcontact.com/us/products/1054732>

## NS 35/15 CAP - End cap

1206573

<https://www.phoenixcontact.com/us/products/1206573>

DIN rail end piece, for DIN rail NS 35/15



---

## E/AL-NS 35 - End clamp

1201662

<https://www.phoenixcontact.com/us/products/1201662>

End clamp, for end support of UKH 50 to UKH 240, is pushed onto DIN rail NS 35 and fixed with 2 screws, width: 10 mm, color: aluminum



# PTPOWER 185 F - High-current terminal block



1054732

<https://www.phoenixcontact.com/us/products/1054732>

## ZB 10:UNBEDRUCKT - Zack marker strip

1053001

<https://www.phoenixcontact.com/us/products/1053001>



Zack marker strip, Strip, white, unlabeled, can be labeled with: PLOTMARK, CMS-P1-PLOTTER, mounting type: snapped, for terminal block width: 10.2 mm, lettering field size: 10.5 x 10.15 mm, Number of individual labels: 10

---

## ZB 10 CUS - Zack marker strip

0824941

<https://www.phoenixcontact.com/us/products/0824941>



Zack marker strip, can be ordered: Strip, white, labeled according to customer specifications, mounting type: snap into tall marker groove, for terminal block width: 10.2 mm, lettering field size: 10,15 x 10,5 mm, Number of individual labels: 10

# PTPOWER 185 F - High-current terminal block



1054732

<https://www.phoenixcontact.com/us/products/1054732>

## ZB10,LGS:FORTL.ZAHLEN - Zack marker strip

1053014

<https://www.phoenixcontact.com/us/products/1053014>



Zack marker strip, Strip, white, labeled, can be labeled with: CMS-P1-PLOTTER, printed horizontally: consecutive numbers 1 ... 10, 11 ... 20, etc. up to 91 ... 100, mounting type: snapped, for terminal block width: 10.2 mm, lettering field size: 10,15 x 10,5 mm, Number of individual labels: 10

---

## ZB10,QR:FORTL.ZAHLEN - Zack marker strip

1053027

<https://www.phoenixcontact.com/us/products/1053027>



Zack marker strip, Strip, white, labeled, can be labeled with: CMS-P1-PLOTTER, Printed vertically: consecutive numbers 1 ... 10, 11 ... 20, etc. up to 91 ... 100, mounting type: snapped, for terminal block width: 10.2 mm, lettering field size: 10,15 x 10,5 mm, Number of individual labels: 10

# PTPOWER 185 F - High-current terminal block



1054732

<https://www.phoenixcontact.com/us/products/1054732>

## ZB10,LGS:L1-N,PE - Marker for terminal blocks

1053412

<https://www.phoenixcontact.com/us/products/1053412>



Marker for terminal blocks, Strip, white, labeled, can be labeled with: CMS-P1-PLOTTER, horizontal: L1, L2, L3, N, PE, L1, L2, L3, N, PE, mounting type: snapped, for terminal block width: 10.2 mm, lettering field size: 10,15 x 10,5 mm, Number of individual labels: 10

---

## ZB10,LGS:U-N - Marker for terminal blocks

1053438

<https://www.phoenixcontact.com/us/products/1053438>



Marker for terminal blocks, Strip, white, labeled, can be labeled with: CMS-P1-PLOTTER, horizontal: U, V, W, N, GND, U, V, W, N, GND, mounting type: snapped, for terminal block width: 10.2 mm, lettering field size: 10,15 x 10,5 mm, Number of individual labels: 10

# PTPOWER 185 F - High-current terminal block



1054732

<https://www.phoenixcontact.com/us/products/1054732>

## UC-TM 10 - Marker for terminal blocks

0818069

<https://www.phoenixcontact.com/us/products/0818069>



Marker for terminal blocks, Sheet, white, unlabeled, can be labeled with: BLUEMARK ID COLOR, BLUEMARK ID, BLUEMARK CLED, PLOTMARK, CMS-P1-PLOTTER, mounting type: snapped, for terminal block width: 10.2 mm, lettering field size: 9.6 x 10.5 mm, Number of individual labels: 48

---

## UC-TM 10 CUS - Marker for terminal blocks

0824605

<https://www.phoenixcontact.com/us/products/0824605>



Marker for terminal blocks, can be ordered: by sheet, white, labeled according to customer specifications, mounting type: snap into tall marker groove, for terminal block width: 10.2 mm, lettering field size: 9.6 x 10.5 mm, Number of individual labels: 48



# PTPOWER 185 F - High-current terminal block



1054732

<https://www.phoenixcontact.com/us/products/1054732>

## UCT-TM 10 - Marker for terminal blocks

0829142

<https://www.phoenixcontact.com/us/products/0829142>



Marker for terminal blocks, Sheet, white, unlabeled, can be labeled with: TOPMARK NEO, TOPMARK LASER, BLUEMARK ID COLOR, BLUEMARK ID, BLUEMARK CLED, THERMOMARK PRIME, THERMOMARK CARD 2.0, THERMOMARK CARD, mounting type: snapped, for terminal block width: 10.2 mm, lettering field size: 8.9 x 9.6 mm, Number of individual labels: 36

---

## UCT-TM 10 CUS - Marker for terminal blocks

0829623

<https://www.phoenixcontact.com/us/products/0829623>



Marker for terminal blocks, can be ordered: by sheet, white, labeled according to customer specifications, mounting type: snap into tall marker groove, for terminal block width: 10.2 mm, lettering field size: 8.9 x 9.6 mm, Number of individual labels: 36

# PTPOWER 185 F - High-current terminal block



1054732

<https://www.phoenixcontact.com/us/products/1054732>

## MPS-MT - Test plugs

0201744

<https://www.phoenixcontact.com/us/products/0201744>



Test plugs, with solder connection up to 1 mm<sup>2</sup> conductor cross section, number of positions: 1, color: gray

---

## MPS-IH WH - Insulating sleeve

0201663

<https://www.phoenixcontact.com/us/products/0201663>

Insulating sleeve, color: white



# PTPOWER 185 F - High-current terminal block



1054732

<https://www.phoenixcontact.com/us/products/1054732>

## MPS-IH RD - Insulating sleeve

0201676

<https://www.phoenixcontact.com/us/products/0201676>

Insulating sleeve, color: red



---

## MPS-IH BU - Insulating sleeve

0201689

<https://www.phoenixcontact.com/us/products/0201689>

Insulating sleeve, color: blue



# PTPOWER 185 F - High-current terminal block

1054732

<https://www.phoenixcontact.com/us/products/1054732>



## MPS-IH YE - Insulating sleeve

0201692

<https://www.phoenixcontact.com/us/products/0201692>

Insulating sleeve, color: yellow



---

## MPS-IH GN - Insulating sleeve

0201702

<https://www.phoenixcontact.com/us/products/0201702>

Insulating sleeve, color: green



# PTPOWER 185 F - High-current terminal block

1054732

<https://www.phoenixcontact.com/us/products/1054732>



## MPS-IH GY - Insulating sleeve

0201728

<https://www.phoenixcontact.com/us/products/0201728>

Insulating sleeve, color: gray



---

## MPS-IH BK - Insulating sleeve

0201731

<https://www.phoenixcontact.com/us/products/0201731>

Insulating sleeve, color: black



# PTPOWER 185 F - High-current terminal block



1054732

<https://www.phoenixcontact.com/us/products/1054732>

## PROJECT COMPLETE - Software

1050453

<https://www.phoenixcontact.com/us/products/1050453>



Intuitive planning and marking software for configuring terminal strips and for professional marking of marking materials for terminal blocks, conductors, cables, devices, and systems. The software is available for download

---

## A 95 -40 - Ferrule

3241242

<https://www.phoenixcontact.com/us/products/3241242>



Ferrule, length: 40 mm, color: silver

# PTPOWER 185 F - High-current terminal block

1054732

<https://www.phoenixcontact.com/us/products/1054732>

## A 120 -40 - Ferrule

1090640

<https://www.phoenixcontact.com/us/products/1090640>



Ferrule, length: 40 mm, color: silver

---

## CRIMPFOX 50R - Crimping pliers

1212041

<https://www.phoenixcontact.com/us/products/1212041>



Crimping pliers, for ferrules without insulating collar according to DIN 46228 Part 1 and ferrules with insulating collar according to DIN 46228 Part 4, 35 mm<sup>2</sup> ... 50 mm<sup>2</sup>, lateral entry, WM crimp

# PTPOWER 185 F - High-current terminal block



1054732

<https://www.phoenixcontact.com/us/products/1054732>

## CRIMPFOX-M - Crimping pliers

1212072

<https://www.phoenixcontact.com/us/products/1212072>



Basic pliers, for accommodating dies for a wide range of type of contacts

---

## CRIMPFOX-C120 - Crimping pliers

1212318

<https://www.phoenixcontact.com/us/products/1212318>



Basic pliers, for accommodating dies for a wide range of type of contacts up to 120 mm<sup>2</sup>

---

Phoenix Contact 2023 © - all rights reserved  
<https://www.phoenixcontact.com>

Phoenix Contact USA  
586 Fulling Mill Road  
Middletown, PA 17057, United States  
(+717) 944-1300  
[info@phoenixcon.com](mailto:info@phoenixcon.com)