

Common mode filters

Automobile ultra high-speed differential signal line (HDMI, LVDS, MIPI, USB3.0)

MCZ-DH series



AEC-Q200

MCZ1210DH_CP type



FEATURES

- Multilayer common mode filter for ultra high-speed differential lines.
- Widened frequency range for differential mode transmission up to 6.0GHz while ensuring common mode impedance.
- Suppresses common mode noise without influencing the high-speed differential transmission line signal.
- Characteristics impedance for differential mode is 100Ω.
- Optimal for noise suppression of ultra high-speed differential transmission lines, HDMI, USB3.0, etc.
- Operating temperature range: -40 to +105°C

APPLICATION

- Ultra high-speed differential interfaces (HDMI, LVDS, MIPI, USB3.0)
- ADAS, Camera, Display, Cluster, LiDAR, Infotainment etc.

PART NUMBER CONSTRUCTION

MCZ	1210	DH	120	CP	T	D25
Series name	LxWxT dimensions 1.25x1.0x0.5 mm	Product identification code	Impedance (Ω) at 100MHz	Internal code	Packaging style	Internal code

CHARACTERISTICS SPECIFICATION TABLE

Common mode impedance	DC resistance	Rated current	Rated voltage	Insulation resistance	Part No.
[100MHz] (Ω) Tolerance	[1 line] (Ω)max.	(mA)max.	(V)max.	(MΩ)min.	
12 ±5Ω	1.50	100	5	10	MCZ1210DH120CPTD25
45 ±25%	2.50	100	5	10	MCZ1210DH500CPTD25
80 ±25%	3.00	100	5	10	MCZ1210DH800CPTD25

* Impedance (Ω) at 100MHz in PART NUMBER CONSTRUCTION is a reference value.

Measurement equipment

Measurement item	Product No.	Manufacturer
Common mode impedance	4991A+16092A	Keysight Technologies
DC resistance	Type-755611	Yokogawa
Insulation resistance	4339B	Keysight Technologies

* Equivalent measurement equipment may be used.

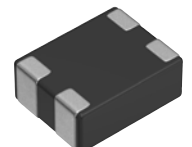

MCZ1210DH_CP type

IMPEDANCE VS. FREQUENCY CHARACTERISTICS

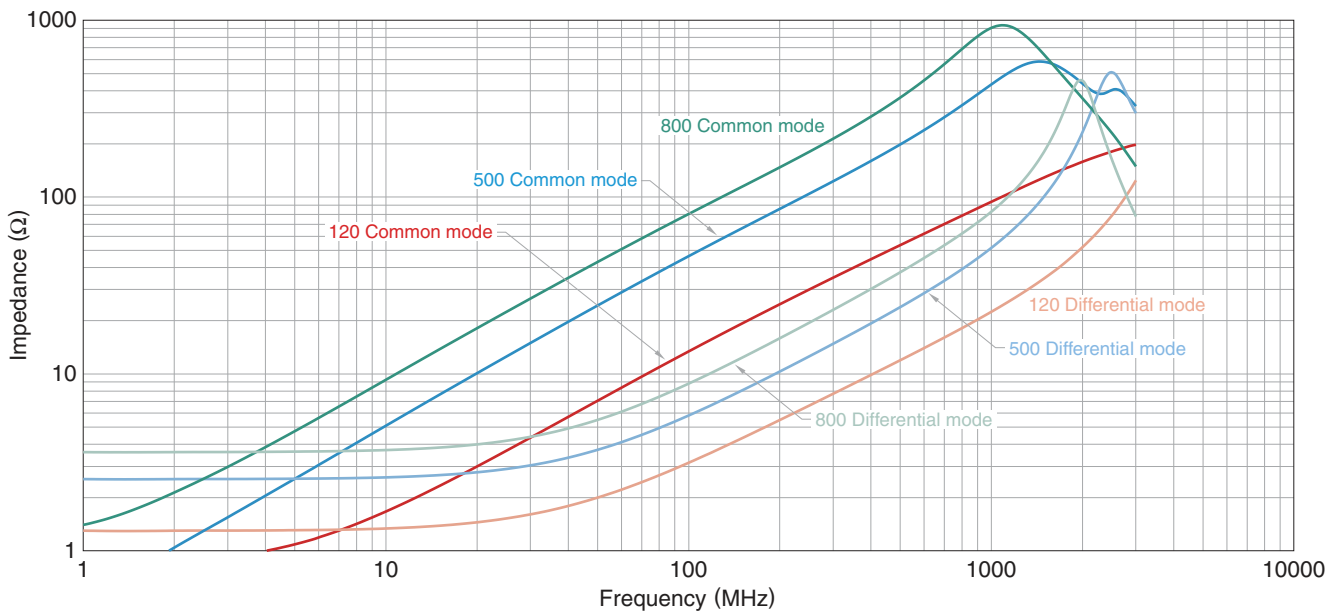

Measurement equipment

Product No.	Manufacturer
4991A+16092A	Keysight Technologies

* Equivalent measurement equipment may be used.

MCZ1210DH_CP type

SHAPE & DIMENSIONS

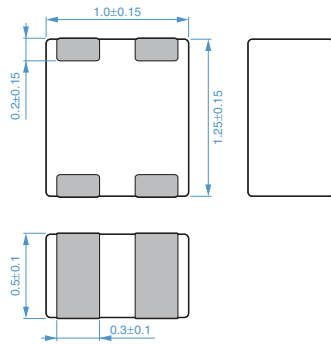

RECOMMENDED LAND PATTERN

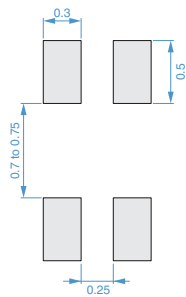

CIRCUIT DIAGRAM

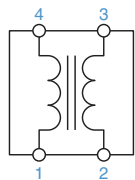

• No polarity

RECOMMENDED REFLOW PROFILE

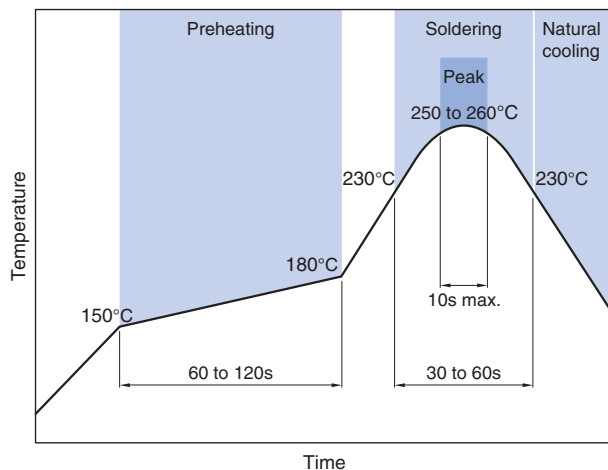

PACKAGING STYLE

REEL DIMENSIONS

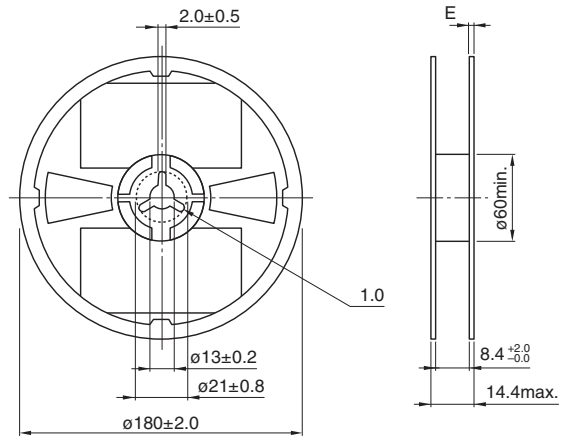

Dimensions in mm

TAPE DIMENSIONS

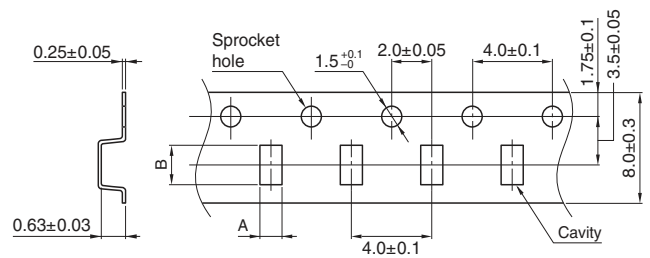

Dimensions in mm

Type	A	B
MCZ1210DH_CP	1.17±0.03	1.40±0.03

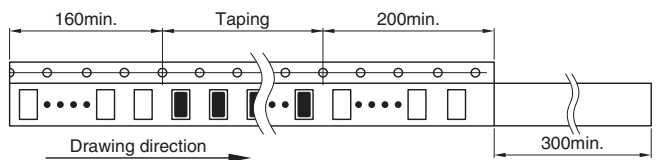

PACKAGE QUANTITY

Package quantity	4,000 pcs/reel
------------------	----------------

TEMPERATURE RANGE, INDIVIDUAL WEIGHT

Operating temperature range	Storage temperature range *	Individual weight
-40 to +105 °C	-40 to +105 °C	3.0 mg

* The storage temperature range is for after the assembly.

REMINDERS FOR USING THESE PRODUCTS

Before using these products, be sure to request the delivery specifications.

SAFETY REMINDERS

Please pay sufficient attention to the warnings for safe designing when using this products

REMINDERS

- The storage period is within 12 months. Be sure to follow the storage conditions (temperature: 5 to 40°C, humidity: 10 to 75% RH or less).
If the storage period elapses, the soldering of the terminal electrodes may deteriorate.
- Do not use or store in locations where there are conditions such as gas corrosion (salt, acid, alkali, etc.).
- Before soldering, be sure to preheat components.
The preheating temperature should be set so that the temperature difference between the solder temperature and chip temperature does not exceed 150°C.
- Soldering corrections after mounting should be within the range of the conditions determined in the specifications.
If overheated, a short circuit, performance deterioration, or lifespan shortening may occur.
- When embedding a printed circuit board where a chip is mounted to a set, be sure that residual stress is not given to the chip due to the overall distortion of the printed circuit board and partial distortion such as at screw tightening portions.
- Self heating (temperature increase) occurs when the power is turned ON, so the tolerance should be sufficient for the set thermal design.
- Carefully lay out the coil for the circuit board design of the non-magnetic shield type.
A malfunction may occur due to magnetic interference.
- Use a wrist band to discharge static electricity in your body through the grounding wire.
- Do not expose the products to magnets or magnetic fields.
- Do not use for a purpose outside of the contents regulated in the delivery specifications.
- The products described in this catalog are intended to be installed in automobiles or automotive electronic equipment (AV equipment, telecommunications equipment, home appliances, amusement equipment, computer equipment, personal equipment, office equipment, measurement equipment, industrial robots) and to be used in automobiles (including the case where the said automotive product is mounted in a vehicle) or standard applications as general electronic equipment in automotive applications or standard applications as general electronic equipment in automotive applications in accordance with the scope and conditions described in this specification, while the said automotive or general electronic equipment including the said product is intended to be used in the usual operation and usage methods, respectively. Other than automotive or automotive products are not designed or warranted to meet the requirements of the applications listed below, whose performance and/or quality requires a more stringent level of safety or reliability, or whose failure, malfunction or defect could cause serious damage to society, person or property.
Please understand that we are not responsible for any damage or liability caused by use of the products in any of the applications below or for any other use exceeding the range or conditions set forth in this specification sheet.
If you intend to use the products in the applications listed below or if you have special requirements exceeding the range or conditions set forth in this specification, please contact us.

- (1) Aerospace/aviation equipment
- (2) Transportation equipment (electric trains, ships, etc.)
- (3) Medical equipment
- (4) Power-generation control equipment
- (5) Atomic energy-related equipment
- (6) Seabed equipment

- (7) Transportation control equipment
- (8) Public information-processing equipment
- (9) Military equipment
- (10) Electric heating apparatus, burning equipment
- (11) Disaster prevention/crime prevention equipment
- (12) Safety equipment
- (13) Other applications that are not considered general-purpose applications

When designing your equipment even for general-purpose applications, you are kindly requested to take into consideration securing protection circuit/device or providing backup circuits in your equipment.