

TPS54678EVM-155 6-A, SWIFT™ Regulator Evaluation Module

Contents

1	Introduction	2
2	Test Setup and Results	4
3	Board Layout	14
4	Schematic and Bill of Materials	19

List of Figures

1	Test Connections	5
2	TPS54678EVM-155 Efficiency	6
3	TPS54678EVM-155 Load Regulation	7
4	TPS54678EVM-155 Line Regulation	7
5	TPS54678EVM-155 Transient Response	8
6	TPS54678EVM-155 Loop Response	8
7	TPS54678EVM-155 Output Ripple at $V_{IN} = 3.0\text{ V}$ and 6 A	9
8	TPS54678EVM-155 Output Ripple at $V_{IN} = 6.0\text{ V}$ and 6 A	9
9	TPS54678EVM-155 Input Ripple at 3 V_{IN} and 6 A	9
10	TPS54678EVM-155 Input Ripple at 6 V_{IN} and 6 A	10
11	TPS54678EVM-155 Start-Up Relative to V_{IN}	11
12	TPS54678EVM-155 Start-up Relative to Enable	11
13	TPS54678EVM-155 Start-up into Pre-bias.....	11
14	TPS54678EVM-155 Shut-down Relative to V_{IN}	12
15	TPS54678EVM-155 Shut-down Relative to EN	12
16	TPS54678EVM-155 Hiccup Mode Current Limit Shut-down	13
17	TPS54678EVM-155 Hiccup Mode Current Limit Restart into Short Circuit.....	13
18	TPS54678EVM-155 Top-Side Assembly.....	14
19	TPS54678EVM-155 Top-Side Layout	15
20	TPS54678EVM-155 Layout 2.....	16
21	TPS54678EVM-155 Layout 3.....	17
22	TPS54678EVM-155 Bottom-Side Layout	18
23	TPS54678EVM-155 Schematic.....	19

List of Tables

1	Input Voltage and Output Current Summary	2
2	TPS54678EVM-155 Performance Specification Summary	2
3	Output Voltages Available	3
4	EVM Connectors and Test Points	5
5	TPS54678EVM-155 Bill of Materials.....	20

SWIFT is a trademark of Texas Instruments.

1 Introduction

This User's Guide contains background information for the TPS54678 as well as support documentation for the TPS54678EVM-155 evaluation module (EVM) (PWR155). Also included are the performance specifications, the schematic, and the bill of materials for the EVM.

1.1 Background

The TPS54678 dc/dc converter is designed to provide up to a 6-A output from an input voltage source of 2.95 V to 6 V. Rated input voltage and output current range for the EVM are given in [Table 1](#). This EVM demonstrates the small printed-circuit board areas that are achieved when designing with the TPS54678 regulator. The switching frequency is externally set at a nominal 500 kHz. The high-side and low-side MOSFETs are incorporated inside the TPS54678 package along with the gate-drive circuitry. The low drain-to-source on resistance of the MOSFETs allow the TPS54678 to achieve high efficiencies and helps keep the junction temperature low at high output currents. The compensation components are external to the integrated circuit (IC), and an external divider allows for an adjustable output voltage. Additionally, the TPS54678 provides adjustable slow start and undervoltage lockout inputs. The absolute maximum input voltage is 7 V for the EVM.

Table 1. Input Voltage and Output Current Summary

EVM	INPUT VOLTAGE RANGE	OUTPUT CURRENT RANGE
TPS54678EVM-155	$V_{IN} = 3 \text{ V to } 6 \text{ V}$	0 A to 6 A

1.2 Performance Specification Summary

A summary of the EVM performance specifications is provided in [Table 2](#). Specifications are given for an input voltage of $V_{IN} = 5 \text{ V}$ and an output voltage of 1.2 V, unless otherwise specified. The EVM is designed and tested for $V_{IN} = 3 \text{ V to } 6 \text{ V}$. The ambient temperature is 25°C for all measurements, unless otherwise noted.

Table 2. TPS54678EVM-155 Performance Specification Summary

PARAMETER	TEST CONDITIONS	MIN	TYP	MAX	UNITS
INPUT CHARACTERISTICS					
Operating voltage range		3	5	6	V
V_{IN} start voltage					V
V_{IN} stop voltage					V
OUTPUT CHARACTERISTICS					
Output voltage, V_{OUT}	Output current = 0 to 6A		1.2		V
Output load current, I_{OUT1}	I_{OUT_min} to I_{OUT_max}	0		6	A
Output voltage regulation	Line Regulation: Input voltage = 3 V to 6 V		0.5%		
	Load Regulation: Output current = 0 A to I_{OUT_max}		0.5%		
Transient response	$I_{OUT} = 3 \text{ A to } 6 \text{ A and } 6 \text{ A to } 3 \text{ A}$	Peak voltage		60	mV
		Recovery time		200	μs
Output voltage ripple	$V_{IN} = 5 \text{ V}, I_{OUT} = 6 \text{ A}$				mVpp
Output over current			10		A
SYSTEMS CHARACTERISTICS					
Switching frequency	F_{SW}		500		kHz
Control loop bandwidth	$V_{IN} = 3.3 \text{ V}, I_O = 6 \text{ A}$				kHz
Phase Margin	$V_{IN} = 3.3 \text{ V}, I_O = 6 \text{ A}$				Degrees
Input ripple voltage					mVp-p
Soft start time					mSec
Peak efficiency	$V_{IN} = V, I_{OUT} = A$				%
Full load efficiency	$V_{IN} = V, I_{OUT} = 6 \text{ A}$				%
Operating temperature	T_{oper}		25		°C

1.3 Modifications

These evaluation modules are designed to provide access to the features of the TPS54678. This module can be modified.

1.3.1 Output Voltage Set Point

The voltage dividers, R9 and R10, are used to set the output voltage. Change the output voltage of the EVM by changing the value of resistor R9. Changing the value of R9 changes the output voltage above 0.6 V. The value of R9 for a specific output voltage is calculated using [Equation 1](#). Use 10.0 kΩ for R10.

$$R9 = R10 \times \left(\frac{V_{OUT}}{0.6 \text{ V}} - 1 \right) \quad (1)$$

[Table 3](#) lists the R9 and R10 values for some common output voltages. Note that V_{IN} must be in a range so that the minimum on-time is greater than 80 ns, and the maximum duty cycle is less than 92%. The values given in [Table 3](#) show standard values and the closest E96 match.

Table 3. Output Voltages Available

R9 Ideal	R9 Actual (E96)	R10	V _{OUT} Ideal	V _{OUT} Actual
0	0	10.0E+3	0.60	0.60
3.33E+3	3.32E+3	10.0E+3	0.80	0.80
6.67E+3	6.65E+3	10.0E+3	1.00	1.00
10.00E+3	10.00E+3	10.0E+3	1.20	1.20
13.33E+3	13.30E+3	10.0E+3	1.40	1.40
16.67E+3	16.50E+3	10.0E+3	1.60	1.59
20.00E+3	20.00E+3	10.0E+3	1.80	1.80
23.33E+3	23.20E+3	10.0E+3	2.00	1.99
26.67E+3	26.70E+3	10.0E+3	2.20	2.20
30.00E+3	30.10E+3	10.0E+3	2.40	2.41
33.33E+3	33.20E+3	10.0E+3	2.60	2.59
36.67E+3	36.50E+3	10.0E+3	2.80	2.79

1.3.2 Slow Start Time

The slow start time is adjusted by changing the value of C7. Use [Equation 2](#) to calculate the required value of C7 for a desired slow start time

$$C_{ss}(\text{nF}) = 3 \times T_{ss}(\text{ms}) \quad (2)$$

C7 is set to 0.01 μF on the EVM for a default slow start time of 3.33 ms.

1.3.3 Adjustable UVLO

The under voltage lock out (UVLO) can be adjusted externally using R1 and R2. The EVM is set for a start voltage of 2.88 V and a stop voltage of 2.57 V using R1 = 47.5 kΩ and R2 = 35.7 kΩ. The following parameters should be used to determine the UVLO performance:

#	Parameter	Value
1	Enable Pin Current when OFF	700 nA
2	Enable Pin Current when ON	2.8 μA + 700 nA
3	Enable Pin Turn ON Threshold	1.3 V
4	Enable Pin Turn OFF Threshold	1.18 V

Use [Equation 3](#) and [Equation 4](#) to calculate required resistor values for different start and stop voltages.

$$I_{R2ON} = \frac{1.30}{R_2}$$

$$I_{R1ON} = I_{R2ON} - 700n = \frac{(V_{ON} - 1.30)}{R_1}$$

$$V_{ON} = \frac{R_1}{R_2}(1.30) - R_1(700n) + 1.30 \quad (3)$$

$$I_{R2OFF} = \frac{1.18}{R_2}$$

$$I_{R1OFF} = I_{R2OFF} - (2.8u + 700n) = \frac{(V_{OFF} - 1.18)}{R_1}$$

$$V_{OFF} = \frac{R_1}{R_2}(1.18) - R_1(2.8u + 700n) + 1.18 \quad (4)$$

2 Test Setup and Results

This section describes how to properly connect, set up, and use the EVM. The section also includes test results typical for the EVM and covers efficiency, output voltage regulation, load transients, loop response, output ripple, input ripple, and start-up.

2.1 Input/Output Connections

The EVM is provided with input/output connectors and test points as shown in [Table 4](#) and [Figure 1](#). A power supply capable of supplying 3 A must be connected to J1 through a pair of 20 AWG wires. The load must be connected to J2 through a pair of 20 AWG wires. The maximum load current capability must be at least 6 A to use the full capability of this EVM. Wire lengths must be minimized to reduce losses in the wires. Test-point, TP1, provides a place to monitor the V_{IN} input voltages with TP2 providing a convenient ground reference. TP8 is used to monitor the output voltage with TP9 as the ground reference.

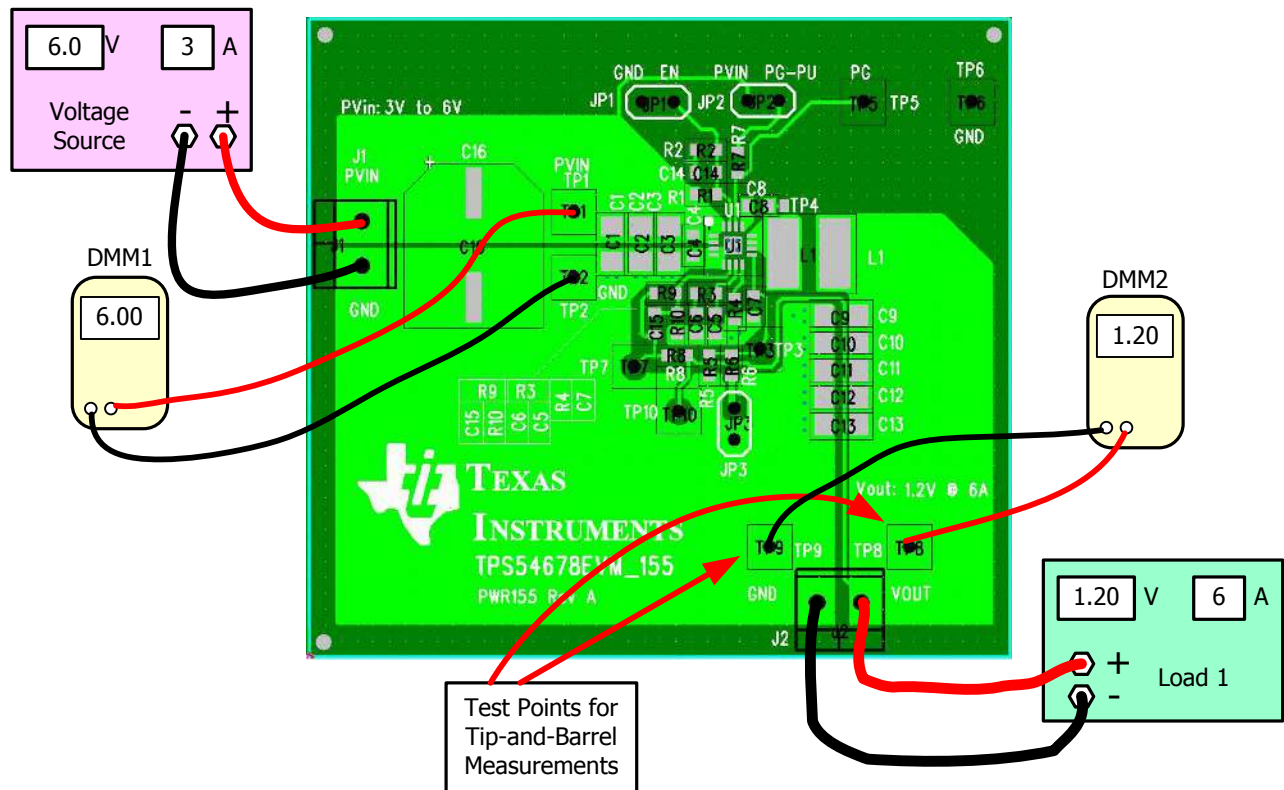

Figure 1. Test Connections

Table 4. EVM Connectors and Test Points

Reference Designator	Function
J1	Input voltage
J2	Access to track function
J3	Output voltage
JP1	2-pin header for enable. Connect EN to ground to disable, open to enable.
JP2	2-pin header allowing pull up of PWRGD to V_{IN} .
TP1	$V_{IN} +VE$
TP2	$V_{IN} -VE$
TP3	SS pin
TP4	Switch node, copper dot
TP5	Power Good pin
TP6	AGND reference
TP7	Bode injection point, input voltage
TP8	$V_{OUT} +VE$
TP9	$V_{OUT} -VE$
TP10	Bode injection point, output voltage

2.2 Efficiency

The efficiency of this EVM peaks at a load current of about 1 A to 2 A and then decreases as the load current increases towards full load. Figure 2 shows the efficiency of the EVM at an ambient temperature of 25°C.

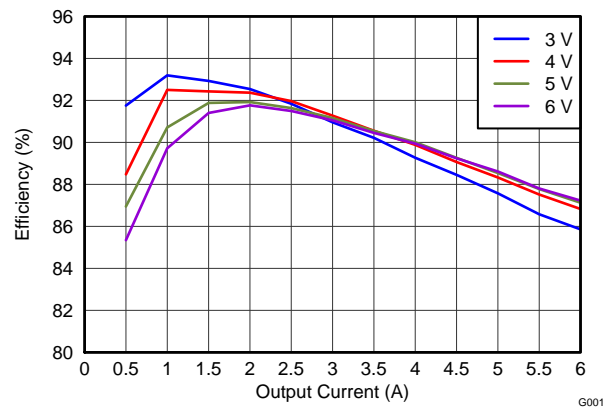

Figure 2. TPS54678EVM-155 Efficiency

The efficiency may be lower at higher ambient temperatures, due to temperature variation in the drain-to-source resistance R_{DS_ON} of the internal MOSFETs.

2.3 Output Voltage Load Regulation

Figure 3 shows the load regulation for the EVM.

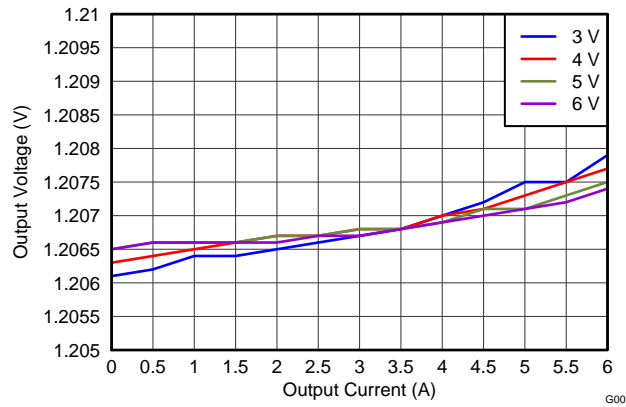

Figure 3. TPS54678EVM-155 Load Regulation

Measurements are given for an ambient temperature of 25°C.

2.4 Output Voltage Line Regulation

Figure 4 shows the line regulation for the EVM.

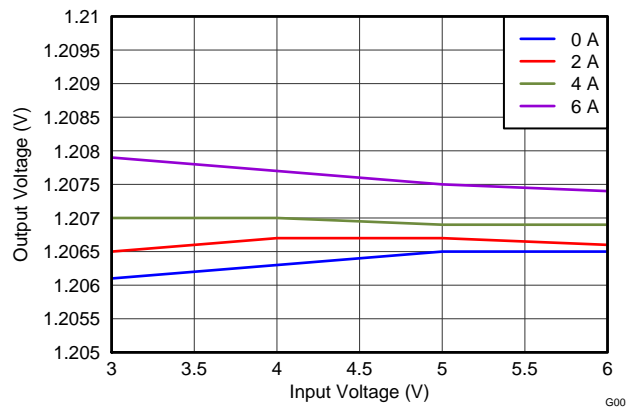
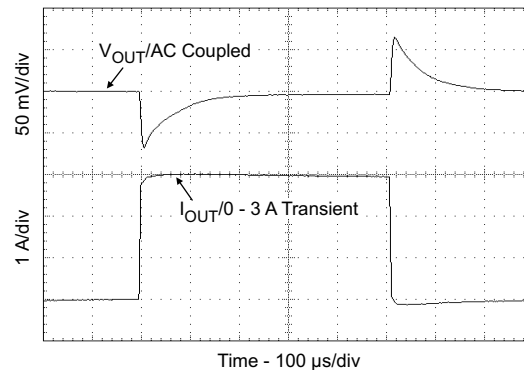

Figure 4. TPS54678EVM-155 Line Regulation

2.5 Load Transients

Figure 5 shows the EVM response to load transients. The current step is from 0% to 50% of maximum rated load at 3.0- V input. Total peak-to-peak voltage variation is as shown.



G004

Figure 5. TPS54678EVM-155 Transient Response

2.6 Loop Characteristics

Figure 6 shows the EVM loop-response characteristics. Gain and phase plots are shown for V_{IN} voltage of 5 V. Load current for the measurement is 6 A.

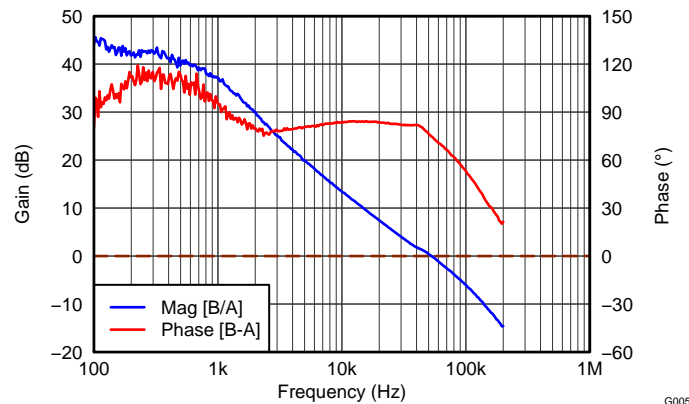

G005

Figure 6. TPS54678EVM-155 Loop Response

2.7 Output Voltage Ripple

Figure 7 shows the EVM output voltage ripple. The output current is the rated full load of 6 A and $V_{IN} = 3.0$ V. The ripple voltage is measured directly across the output capacitors.

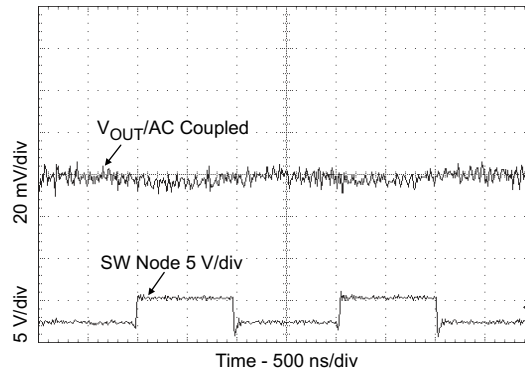

G006

Figure 7. TPS54678EVM-155 Output Ripple at $V_{IN} = 3.0$ V and 6 A

Figure 8 shows the ripple at 6 A and $V_{IN} = 6.0$ V. The ripple voltage is measured directly across the output capacitors.

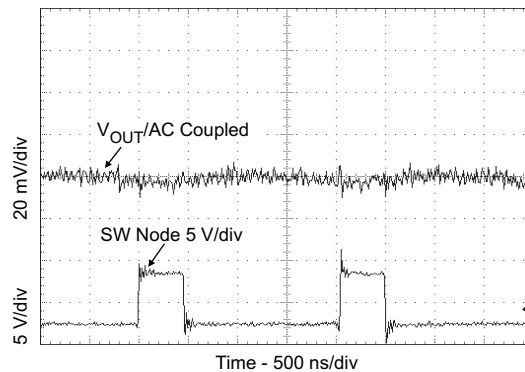

G007

Figure 8. TPS54678EVM-155 Output Ripple at $V_{IN} = 6.0$ V and 6 A

2.8 Input Voltage Ripple

Figure 9 shows the EVM input voltage ripple. The output current is the rated full load of 6 A and $V_{IN} = 3.0$ V. The ripple voltage is measured directly across the input capacitors.

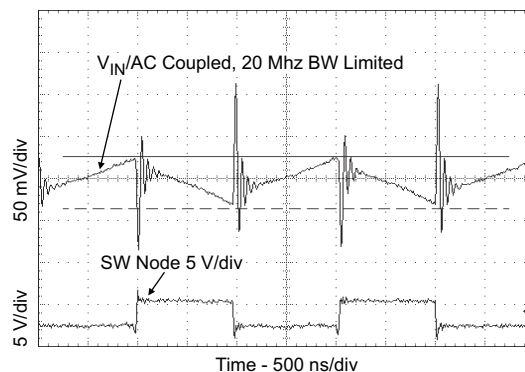

G008

Figure 9. TPS54678EVM-155 Input Ripple at 3 V_{IN} and 6 A

Figure 10 shows the EVM input voltage ripple. The output current is the rated full load of 6 A and $V_{IN} = 6.0$ V. The ripple voltage is measured directly across the input capacitors.

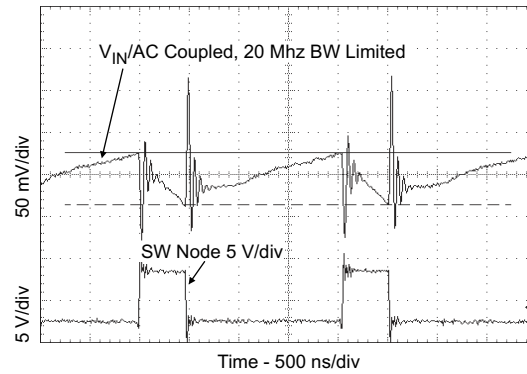

G009

Figure 10. TPS54678EVM-155 Input Ripple at 6 V_{IN} and 6 A

2.9 Powering Up

Figure 11 and Figure 12 show the start-up waveforms for the EVM. In Figure 11, the output voltage ramps up as soon as the input voltage reaches the UVLO threshold as set by the R1 and R2 resistor divider network. In Figure 12, the input voltage is initially applied and the output is inhibited by using a jumper at JP1 to tie EN to GND. When the jumper is removed, EN is released. When the EN voltage reaches the enable-threshold voltage, the start-up sequence begins and the output voltage ramps up to the externally set value of 1.2 V.

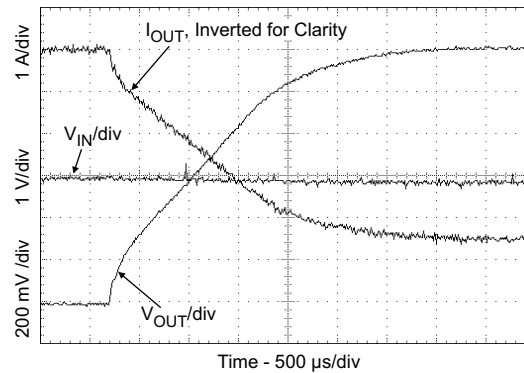

G010

Figure 11. TPS54678EVM-155 Start-up Relative to V_{IN}

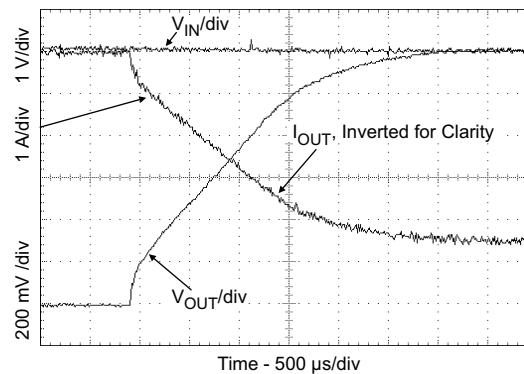

G011

Figure 12. TPS54678EVM-155 Start-up Relative to Enable

The TPS54678 is designed to start up into pre-biased outputs. Figure 13 shows the output voltage start up waveform when the output is prebiased with 550 mV.

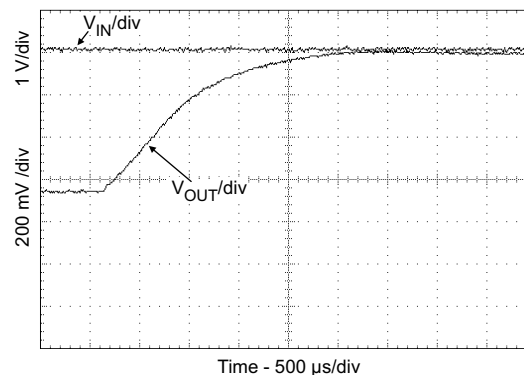

G012

Figure 13. TPS54678EVM-155 Start-up into Pre-bias

2.10 Powering Down

Figure 14 and Figure 15 show the shut down waveforms for the EVM. In Figure 14, the output voltage ramps down as soon as the input voltage falls below the UVLO stop threshold as set by the R1 and R2 resistor divider network. At the point of shutdown, the input voltage rises slightly due to the resistive drop in the input feed impedance. In Figure 15, the output is inhibited by using a jumper at JP1 to tie EN to GND.

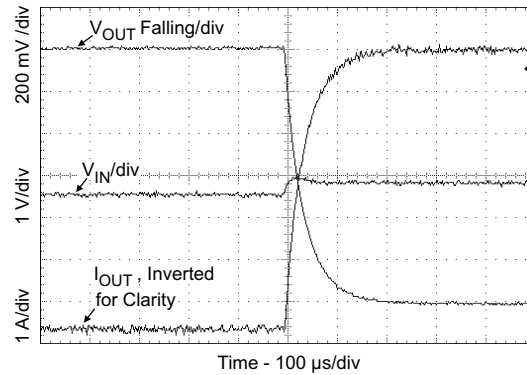

G013

Figure 14. TPS54678EVM-155 Shut-down Relative to V_{IN}

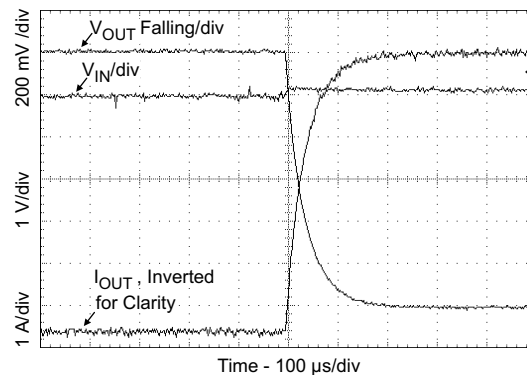

G014

Figure 15. TPS54678EVM-155 Shut-down Relative to EN

2.11 Hiccup Mode Current Limit

The TPS54678 has hiccup mode current limit. When the peak switch current exceeds the current limit threshold, the device shuts down and restarts. Hiccup mode current limit operation is shown in Figure 16 and Figure 17. Figure 16 shows the activation of hiccup mode current limit. When the peak current limit is exceeded, the output voltage is disabled. Figure 17 shows the operation of the TPS54678 with the output shorted to ground. The device will continuously reset until the fault condition is removed.

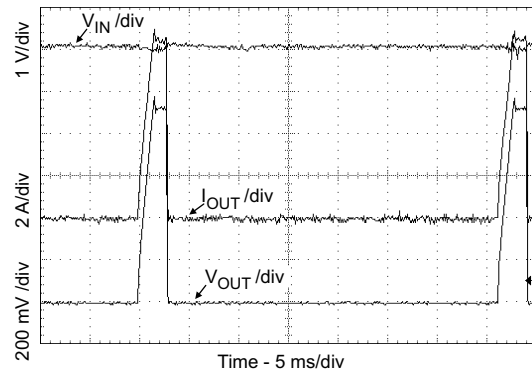

G015

Figure 16. TPS54678EVM-155 Hiccup Mode Current Limit Shut-down

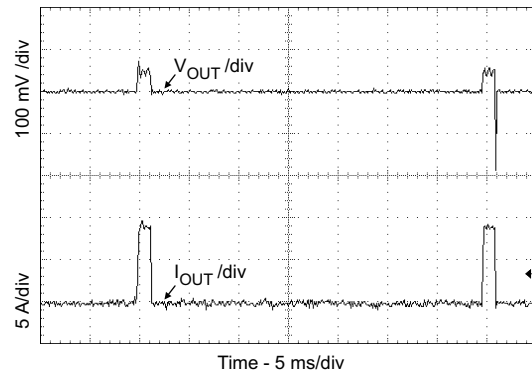

G016

Figure 17. TPS54678EVM-155 Hiccup Mode Current Limit Restart into Short Circuit

3 Board Layout

This section provides a description of the EVM, board layout, and layer illustrations.

3.1 Layout

The following figures show the board layout for the EVM. The topside layer of the EVM is laid out in a manner typical of a user application. The top and bottom layers are 2-oz copper, and the two internal layers are 1-oz copper. The top layer contains the main power traces for V_{IN} , V_{OUT} , and V_{PHASE} . Also on the top layer are connections for the remaining pins of the TPS54678 and a large area filled with ground. The bottom and internal layers contain ground planes only. The top-side ground areas are connected to the bottom and internal ground planes with multiple vias placed around the board including four vias directly under the TPS54678 device to provide a thermal path from the top-side ground area to the bottom-side and internal ground planes. The input decoupling capacitors (C1, C2, C3, and C4) and bootstrap capacitor (C8) are all located as close to the IC as possible. In addition, the voltage set-point resistor divider components are also kept close to the IC. The voltage divider network ties to the output voltage at the point of regulation, which is the copper V_{OUT} trace near the output connector, J2. For the TPS54678, an additional input bulk capacitor, C16, is included to provide lower-source impedance, to yield functionality that is less dependent on the impedance of the distribution connection to the input supply.

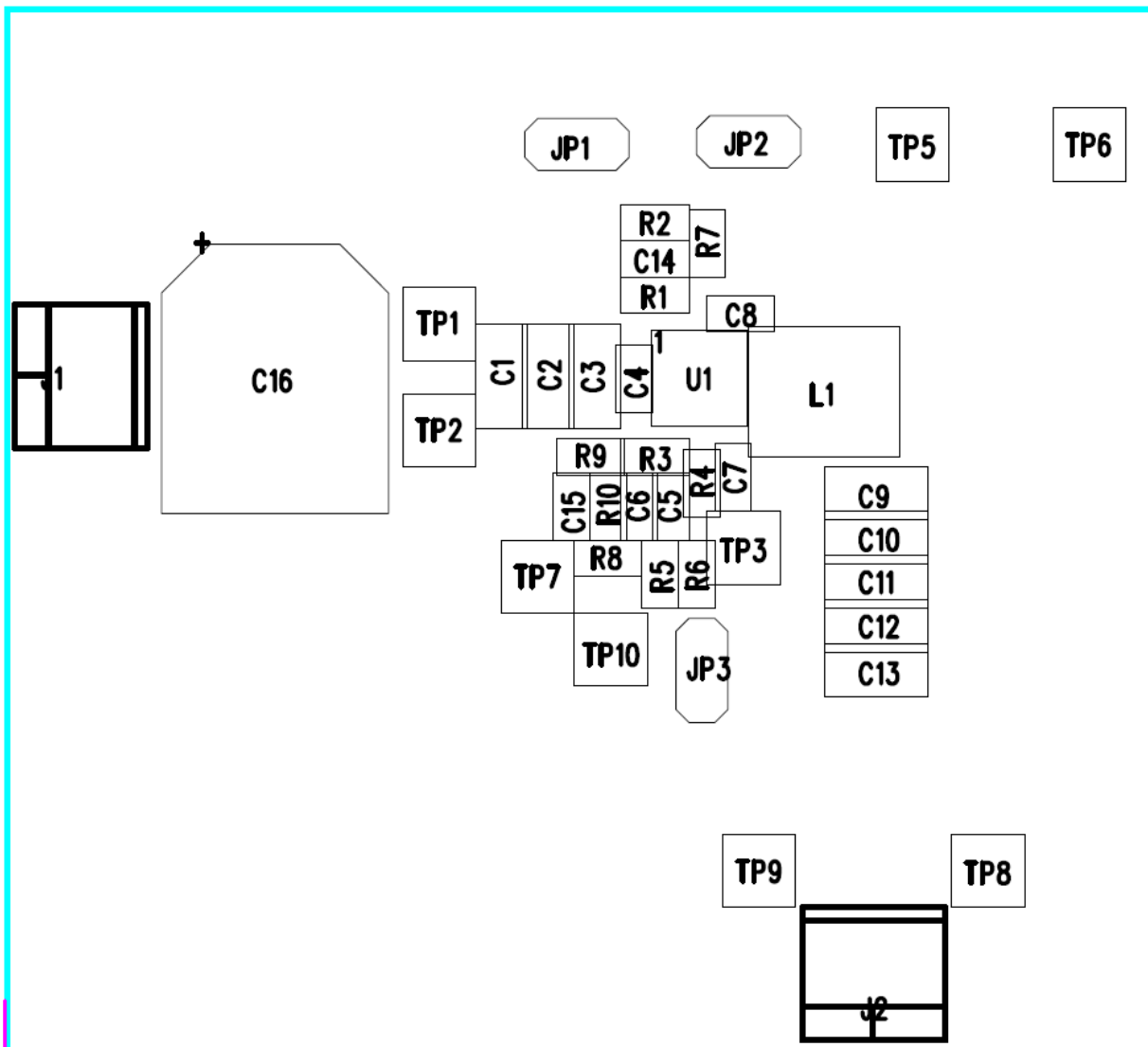

Figure 18. TPS54678EVM-155 Top-Side Assembly

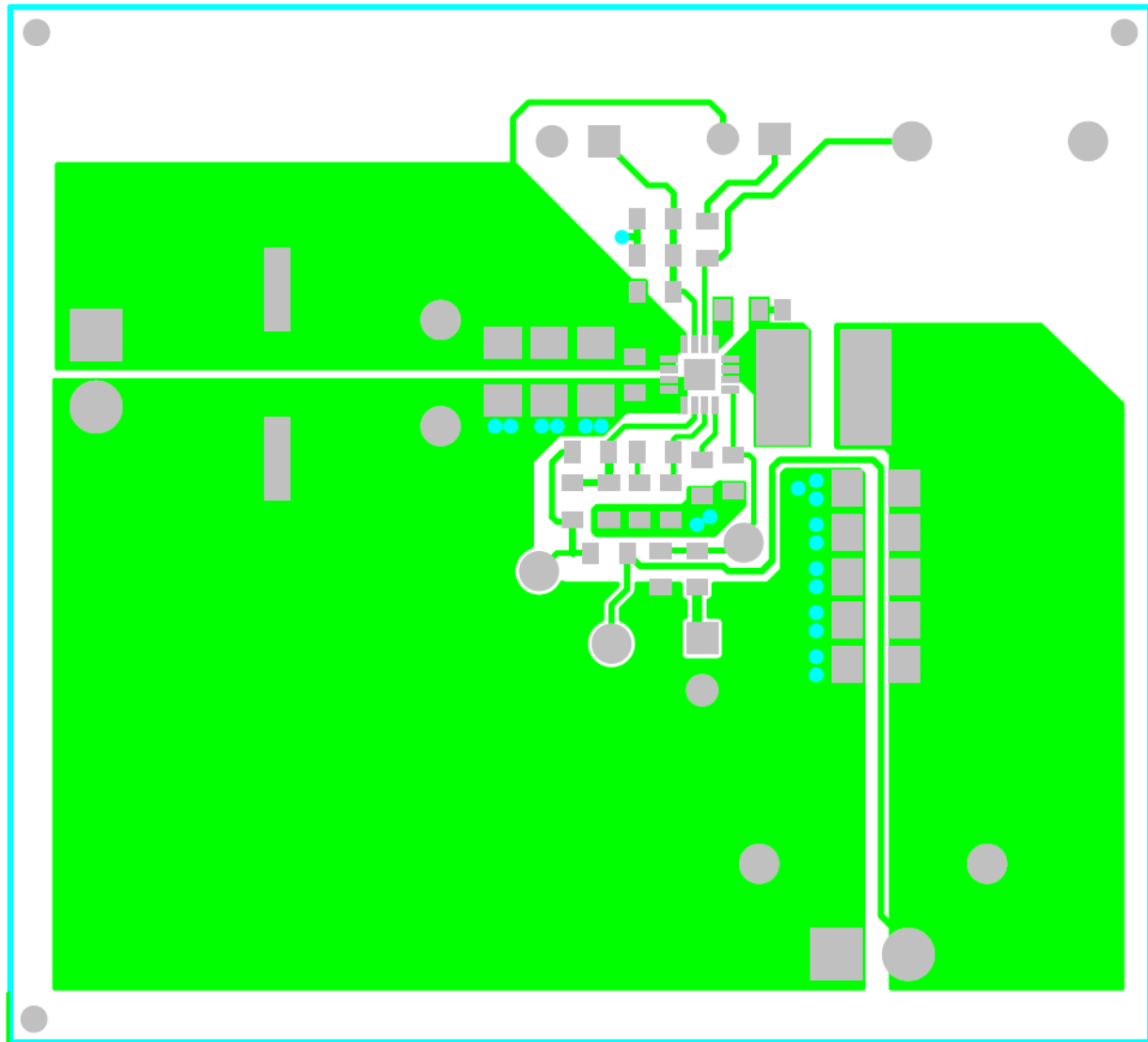

Figure 19. TPS54678EVM-155 Top-Side Layout

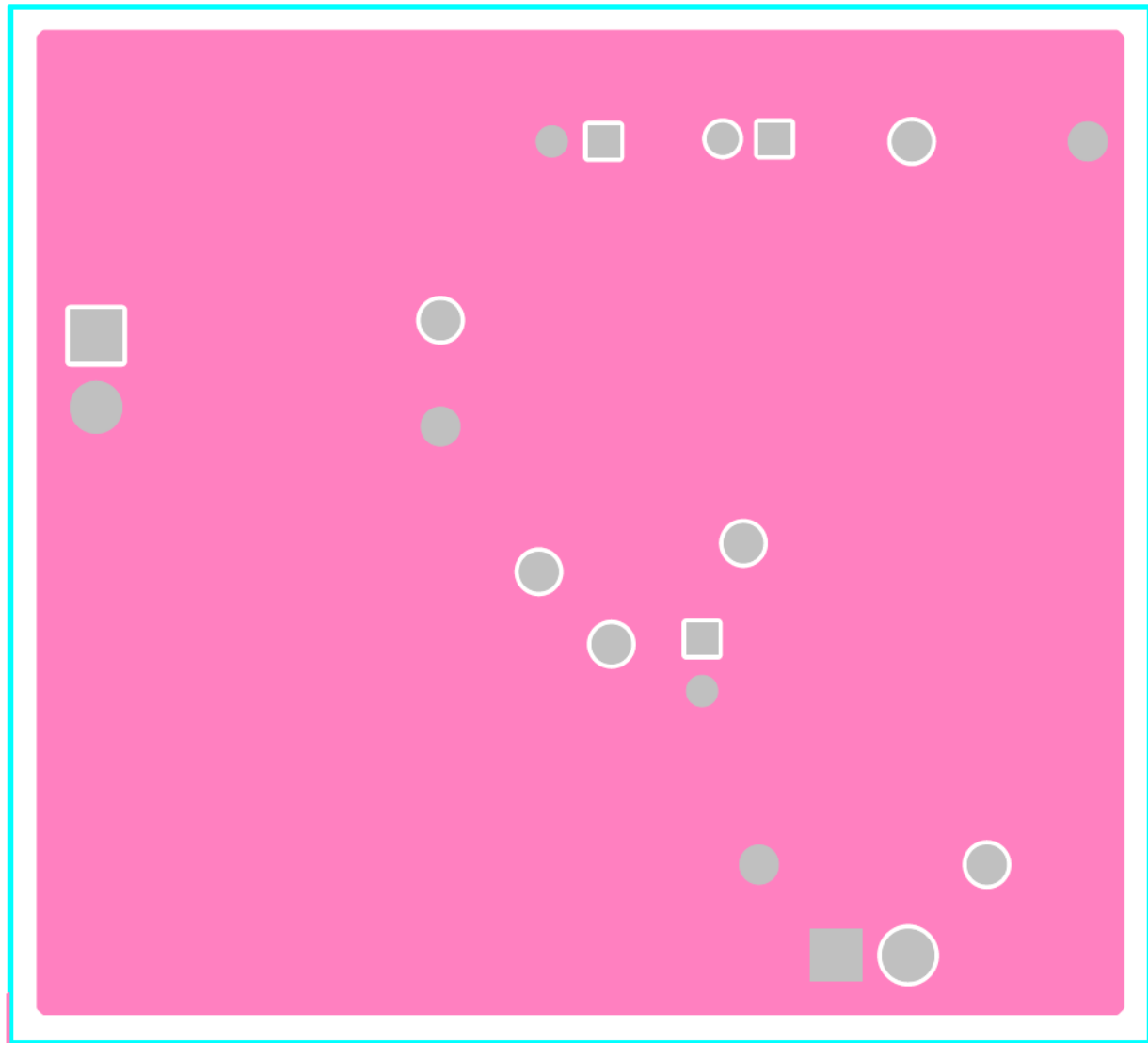

Figure 20. TPS54678EVM-155 Layout 2

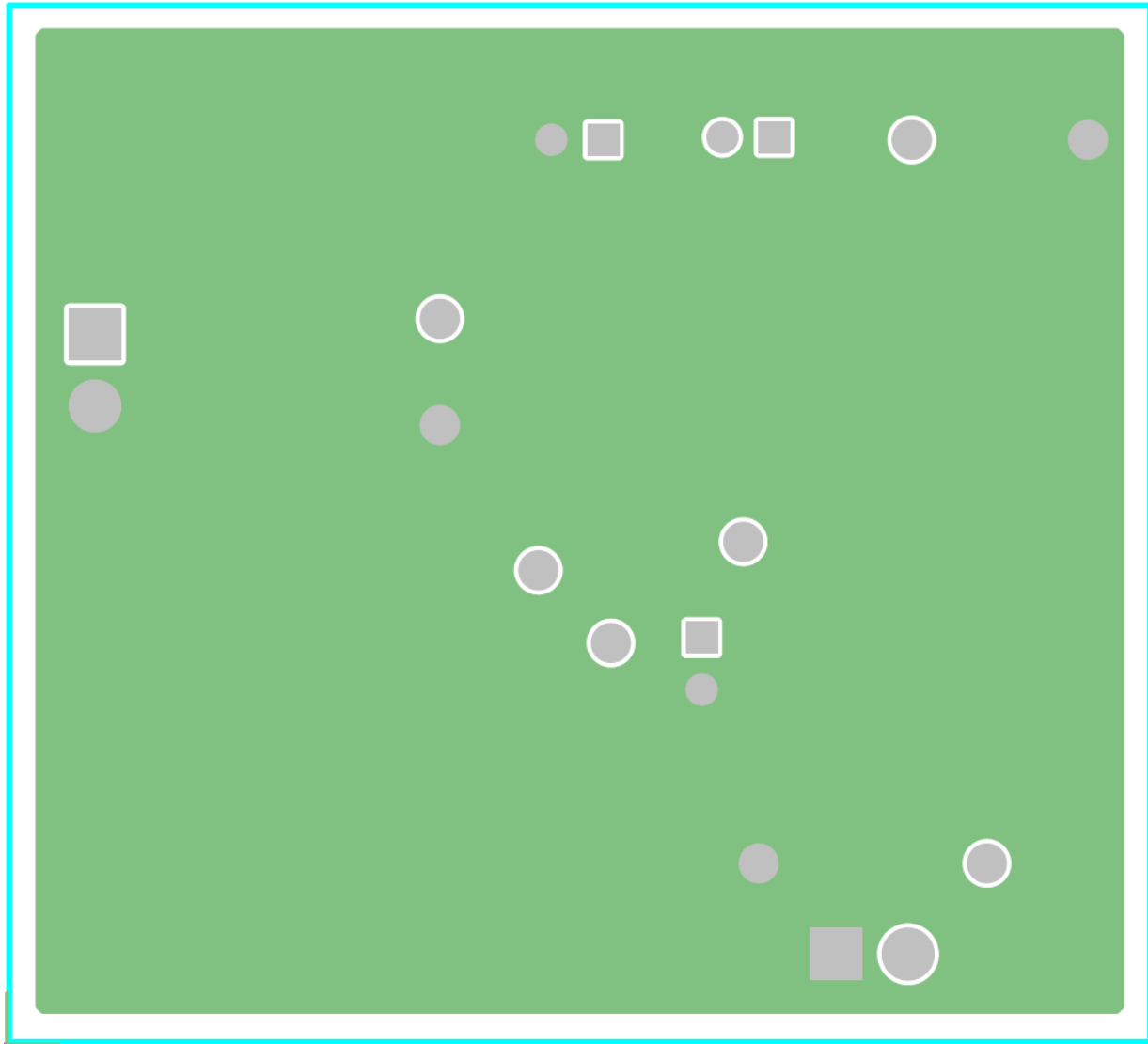

Figure 21. TPS54678EVM-155 Layout 3

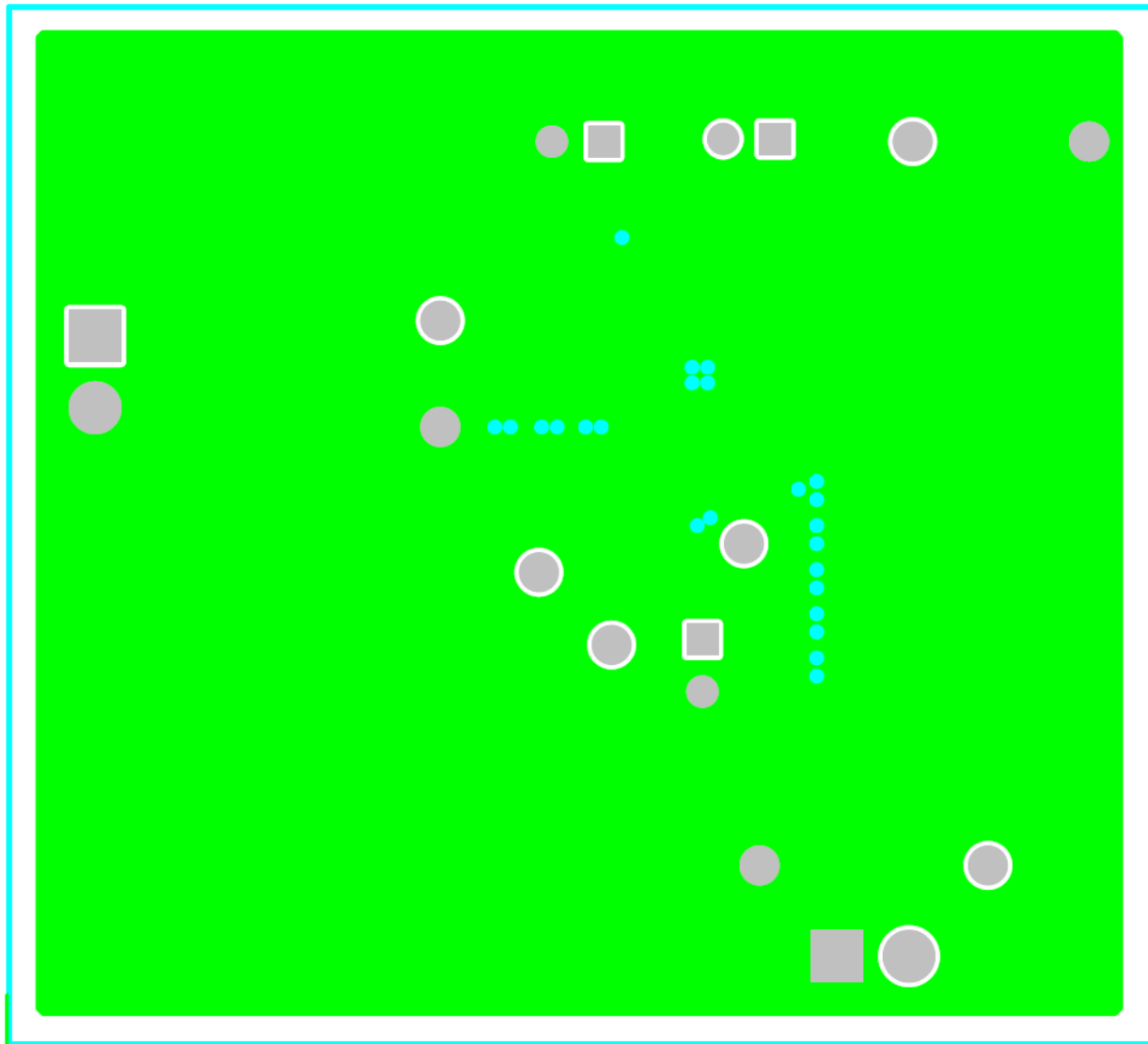

Figure 22. TPS54678EVM-155 Bottom-Side Layout

4 Schematic and Bill of Materials

This section presents the EVM schematic and bill of materials.

4.1 Schematic

Figure 23 is the schematic for the EVM.

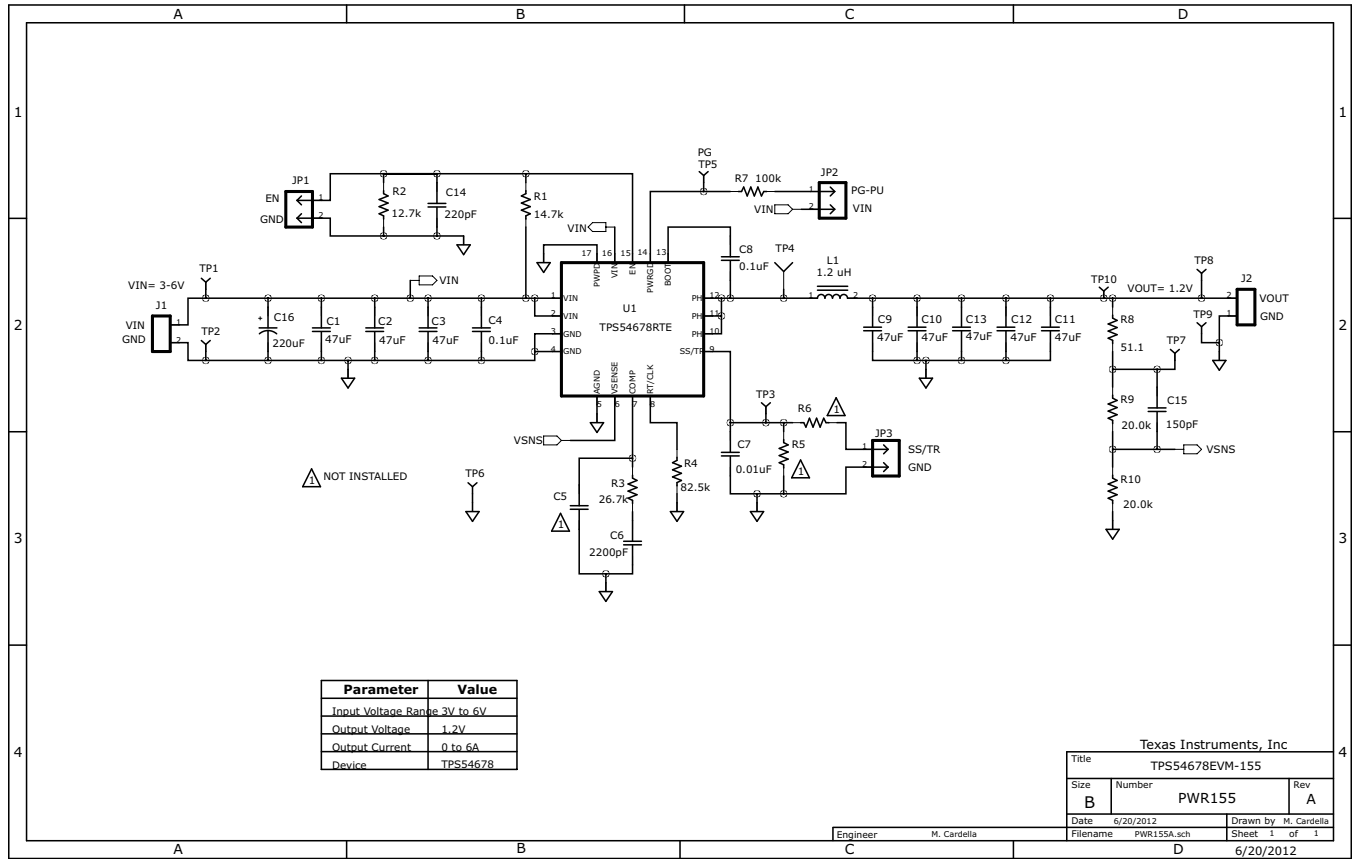

Figure 23. TPS54678EVM-155 Schematic

4.2 Bill of Materials

Table 5 presents the bill of materials for the EVM.

Table 5. TPS54678EVM-155 Bill of Materials

RefDes	Value	Description	Size	Part Number	MFR
C4, C8	0.1 μ F	Capacitor, ceramic, 50 V, X5R, 10%	603	Std	Std
C5	Open	Capacitor, ceramic	603	Std	Std
C6	2200 pF	Capacitor, ceramic, 50 V, X7R, 10%	603	Std	Std
C7	0.01 μ F	Capacitor, ceramic, 25 V, X7R, 10%	603	Std	Std
C14	220 pF	Capacitor, ceramic, 50 V, C0G, 5%	603	Std	Std
C15	150 pF	Capacitor, ceramic, 50 V, C0G, 5%	603	Std	Std
C1-3 C9-13	47 μ F	Capacitor, ceramic, 10 V, X5R, \pm 20%	1206	Std	Std
C16	220 μ F	Capacitor, Electrolytic, SMT, 50 VDC	0.457 x 0.406	EEE-FK1H221P	Panasonic
JP1-2-3	PEC02SAAN	Header, Male 2-pin, 100mil spacing	0.100 in x 2	PEC02SAAN	Sullins
L1	1.2 μ H	Inductor, SMD Shielded Power, 11.8 A, 7.4 m Ω	5.3 x 5.5 mm	XAL5030-122ME	Coilcraft
R1	14.7 k Ω	Resistor, chip, 1/10W, 1%	603	Std	Std
R2	12.7 k Ω	Resistor, chip, 1/10W, 1%	603	Std	Std
R3	26.7 k Ω	Resistor, chip, 1/10W, 1%	603	Std	Std
R4	82.5 k Ω	Resistor, chip, 1/10W, 1%	603	Std	Std
R5-6	Open	Resistor, chip, 1/10W, 1%	603	Std	Std
R7	100 k Ω	Resistor, chip, 1/10W, 1%	603	Std	Std
R8	51.1 Ω	Resistor, chip, 1/10W, 1%	603	Std	Std
R9, R10	20.0 k Ω	Resistor, chip, 1/10W, 1%	603	Std	Std
J1 J3	ED555/2DS	Terminal Block, 2-pin, 6-A, 3.5 mm	0.27 x 0.25 in	ED555/2DS	OST
TP1 TP3 TP5-8 TP10	5000	Test Point, Red, Thru Hole Color Keyed	0.100 x 0.100 in	5000	Keystone
TP2 TP9	5001	Test Point, Black, Thru Hole Color Keyed	0.100 x 0.100 in	5001	Keystone
U1	TPS54678RTE	IC, 3-V to 6-V Input, 6-A Output, 2 MHz, Sync. Step-Down Switcher With Integrated FET	QFN	TPS54678RTE	TI
Label		Label	1.25 x 0.25 in	THT-13-457-10	Brady

EVALUATION BOARD/KIT/MODULE (EVM) ADDITIONAL TERMS

Texas Instruments (TI) provides the enclosed Evaluation Board/Kit/Module (EVM) under the following conditions:

The user assumes all responsibility and liability for proper and safe handling of the goods. Further, the user indemnifies TI from all claims arising from the handling or use of the goods.

Should this evaluation board/kit not meet the specifications indicated in the User's Guide, the board/kit may be returned within 30 days from the date of delivery for a full refund. THE FOREGOING LIMITED WARRANTY IS THE EXCLUSIVE WARRANTY MADE BY SELLER TO BUYER AND IS IN LIEU OF ALL OTHER WARRANTIES, EXPRESSED, IMPLIED, OR STATUTORY, INCLUDING ANY WARRANTY OF MERCHANTABILITY OR FITNESS FOR ANY PARTICULAR PURPOSE. EXCEPT TO THE EXTENT OF THE INDEMNITY SET FORTH ABOVE, NEITHER PARTY SHALL BE LIABLE TO THE OTHER FOR ANY INDIRECT, SPECIAL, INCIDENTAL, OR CONSEQUENTIAL DAMAGES.

Please read the User's Guide and, specifically, the Warnings and Restrictions notice in the User's Guide prior to handling the product. This notice contains important safety information about temperatures and voltages. For additional information on TI's environmental and/or safety programs, please visit www.ti.com/esh or contact TI.

No license is granted under any patent right or other intellectual property right of TI covering or relating to any machine, process, or combination in which such TI products or services might be or are used. TI currently deals with a variety of customers for products, and therefore our arrangement with the user is not exclusive. TI assumes no liability for applications assistance, customer product design, software performance, or infringement of patents or services described herein.

REGULATORY COMPLIANCE INFORMATION

As noted in the EVM User's Guide and/or EVM itself, this EVM and/or accompanying hardware may or may not be subject to the Federal Communications Commission (FCC) and Industry Canada (IC) rules.

For EVMs **not** subject to the above rules, this evaluation board/kit/module is intended for use for ENGINEERING DEVELOPMENT, DEMONSTRATION OR EVALUATION PURPOSES ONLY and is not considered by TI to be a finished end product fit for general consumer use. It generates, uses, and can radiate radio frequency energy and has not been tested for compliance with the limits of computing devices pursuant to part 15 of FCC or ICES-003 rules, which are designed to provide reasonable protection against radio frequency interference. Operation of the equipment may cause interference with radio communications, in which case the user at his own expense will be required to take whatever measures may be required to correct this interference.

General Statement for EVMs including a radio

User Power/Frequency Use Obligations: This radio is intended for development/professional use only in legally allocated frequency and power limits. Any use of radio frequencies and/or power availability of this EVM and its development application(s) must comply with local laws governing radio spectrum allocation and power limits for this evaluation module. It is the user's sole responsibility to only operate this radio in legally acceptable frequency space and within legally mandated power limitations. Any exceptions to this are strictly prohibited and unauthorized by Texas Instruments unless user has obtained appropriate experimental/development licenses from local regulatory authorities, which is responsibility of user including its acceptable authorization.

For EVMs annotated as FCC – FEDERAL COMMUNICATIONS COMMISSION Part 15 Compliant

Caution

This device complies with part 15 of the FCC Rules. Operation is subject to the following two conditions: (1) This device may not cause harmful interference, and (2) this device must accept any interference received, including interference that may cause undesired operation.

Changes or modifications not expressly approved by the party responsible for compliance could void the user's authority to operate the equipment.

FCC Interference Statement for Class A EVM devices

This equipment has been tested and found to comply with the limits for a Class A digital device, pursuant to part 15 of the FCC Rules. These limits are designed to provide reasonable protection against harmful interference when the equipment is operated in a commercial environment. This equipment generates, uses, and can radiate radio frequency energy and, if not installed and used in accordance with the instruction manual, may cause harmful interference to radio communications. Operation of this equipment in a residential area is likely to cause harmful interference in which case the user will be required to correct the interference at his own expense.

FCC Interference Statement for Class B EVM devices

This equipment has been tested and found to comply with the limits for a Class B digital device, pursuant to part 15 of the FCC Rules. These limits are designed to provide reasonable protection against harmful interference in a residential installation. This equipment generates, uses and can radiate radio frequency energy and, if not installed and used in accordance with the instructions, may cause harmful interference to radio communications. However, there is no guarantee that interference will not occur in a particular installation. If this equipment does cause harmful interference to radio or television reception, which can be determined by turning the equipment off and on, the user is encouraged to try to correct the interference by one or more of the following measures:

- Reorient or relocate the receiving antenna.
- Increase the separation between the equipment and receiver.
- Connect the equipment into an outlet on a circuit different from that to which the receiver is connected.
- Consult the dealer or an experienced radio/TV technician for help.

For EVMs annotated as IC – INDUSTRY CANADA Compliant

This Class A or B digital apparatus complies with Canadian ICES-003.

Changes or modifications not expressly approved by the party responsible for compliance could void the user's authority to operate the equipment.

Concerning EVMs including radio transmitters

This device complies with Industry Canada licence-exempt RSS standard(s). Operation is subject to the following two conditions: (1) this device may not cause interference, and (2) this device must accept any interference, including interference that may cause undesired operation of the device.

Concerning EVMs including detachable antennas

Under Industry Canada regulations, this radio transmitter may only operate using an antenna of a type and maximum (or lesser) gain approved for the transmitter by Industry Canada. To reduce potential radio interference to other users, the antenna type and its gain should be so chosen that the equivalent isotropically radiated power (e.i.r.p.) is not more than that necessary for successful communication.

This radio transmitter has been approved by Industry Canada to operate with the antenna types listed in the user guide with the maximum permissible gain and required antenna impedance for each antenna type indicated. Antenna types not included in this list, having a gain greater than the maximum gain indicated for that type, are strictly prohibited for use with this device.

Cet appareil numérique de la classe A ou B est conforme à la norme NMB-003 du Canada.

Les changements ou les modifications pas expressément approuvés par la partie responsable de la conformité ont pu vider l'autorité de l'utilisateur pour actionner l'équipement.

Concernant les EVMs avec appareils radio

Le présent appareil est conforme aux CNR d'Industrie Canada applicables aux appareils radio exempts de licence. L'exploitation est autorisée aux deux conditions suivantes : (1) l'appareil ne doit pas produire de brouillage, et (2) l'utilisateur de l'appareil doit accepter tout brouillage radioélectrique subi, même si le brouillage est susceptible d'en compromettre le fonctionnement.

Concernant les EVMs avec antennes détachables

Conformément à la réglementation d'Industrie Canada, le présent émetteur radio peut fonctionner avec une antenne d'un type et d'un gain maximal (ou inférieur) approuvé pour l'émetteur par Industrie Canada. Dans le but de réduire les risques de brouillage radioélectrique à l'intention des autres utilisateurs, il faut choisir le type d'antenne et son gain de sorte que la puissance isotrope rayonnée équivalente (p.i.r.e.) ne dépasse pas l'intensité nécessaire à l'établissement d'une communication satisfaisante.

Le présent émetteur radio a été approuvé par Industrie Canada pour fonctionner avec les types d'antenne énumérés dans le manuel d'usage et ayant un gain admissible maximal et l'impédance requise pour chaque type d'antenne. Les types d'antenne non inclus dans cette liste, ou dont le gain est supérieur au gain maximal indiqué, sont strictement interdits pour l'exploitation de l'émetteur.

【Important Notice for Users of this Product in Japan】

This development kit is NOT certified as Confirming to Technical Regulations of Radio Law of Japan

If you use this product in Japan, you are required by Radio Law of Japan to follow the instructions below with respect to this product:

1. Use this product in a shielded room or any other test facility as defined in the notification #173 issued by Ministry of Internal Affairs and Communications on March 28, 2006, based on Sub-section 1.1 of Article 6 of the Ministry's Rule for Enforcement of Radio Law of Japan,
2. Use this product only after you obtained the license of Test Radio Station as provided in Radio Law of Japan with respect to this product, or
3. Use of this product only after you obtained the Technical Regulations Conformity Certification as provided in Radio Law of Japan with respect to this product. Also, please do not transfer this product, unless you give the same notice above to the transferee. Please note that if you could not follow the instructions above, you will be subject to penalties of Radio Law of Japan.

Texas Instruments Japan Limited
(address) 24-1, Nishi-Shinjuku 6 chome, Shinjuku-ku, Tokyo, Japan

<http://www.tij.co.jp>

【ご使用にあたっての注】

本開発キットは技術基準適合証明を受けておりません。

本製品のご使用に際しては、電波法遵守のため、以下のいずれかの措置を取っていただく必要がありますのでご注意ください。

1. 電波法施行規則第6条第1項第1号に基づく平成18年3月28日総務省告示第173号で定められた電波暗室等の試験設備でご使用いただく。
2. 実験局の免許を取得後ご使用いただく。
3. 技術基準適合証明を取得後ご使用いただく。

なお、本製品は、上記の「ご使用にあたっての注意」を譲渡先、移転先に通知しない限り、譲渡、移転できないものとします。

上記を遵守頂けない場合は、電波法の罰則が適用される可能性があることをご留意ください。

日本テキサス・インスツルメンツ株式会社
東京都新宿区西新宿6丁目24番1号
西新宿三井ビル

<http://www.tij.co.jp>

EVALUATION BOARD/KIT/MODULE (EVM) WARNINGS, RESTRICTIONS AND DISCLAIMERS

For Feasibility Evaluation Only, in Laboratory/Development Environments. Unless otherwise indicated, this EVM is not a finished electrical equipment and not intended for consumer use. It is intended solely for use for preliminary feasibility evaluation in laboratory/development environments by technically qualified electronics experts who are familiar with the dangers and application risks associated with handling electrical mechanical components, systems and subsystems. It should not be used as all or part of a finished end product.

Your Sole Responsibility and Risk. You acknowledge, represent and agree that:

1. You have unique knowledge concerning Federal, State and local regulatory requirements (including but not limited to Food and Drug Administration regulations, if applicable) which relate to your products and which relate to your use (and/or that of your employees, affiliates, contractors or designees) of the EVM for evaluation, testing and other purposes.
2. You have full and exclusive responsibility to assure the safety and compliance of your products with all such laws and other applicable regulatory requirements, and also to assure the safety of any activities to be conducted by you and/or your employees, affiliates, contractors or designees, using the EVM. Further, you are responsible to assure that any interfaces (electronic and/or mechanical) between the EVM and any human body are designed with suitable isolation and means to safely limit accessible leakage currents to minimize the risk of electrical shock hazard.
3. You will employ reasonable safeguards to ensure that your use of the EVM will not result in any property damage, injury or death, even if the EVM should fail to perform as described or expected.
4. You will take care of proper disposal and recycling of the EVM's electronic components and packing materials.

Certain Instructions. It is important to operate this EVM within TI's recommended specifications and environmental considerations per the user guidelines. Exceeding the specified EVM ratings (including but not limited to input and output voltage, current, power, and environmental ranges) may cause property damage, personal injury or death. If there are questions concerning these ratings please contact a TI field representative prior to connecting interface electronics including input power and intended loads. Any loads applied outside of the specified output range may result in unintended and/or inaccurate operation and/or possible permanent damage to the EVM and/or interface electronics. Please consult the EVM User's Guide prior to connecting any load to the EVM output. If there is uncertainty as to the load specification, please contact a TI field representative. During normal operation, some circuit components may have case temperatures greater than 60°C as long as the input and output are maintained at a normal ambient operating temperature. These components include but are not limited to linear regulators, switching transistors, pass transistors, and current sense resistors which can be identified using the EVM schematic located in the EVM User's Guide. When placing measurement probes near these devices during normal operation, please be aware that these devices may be very warm to the touch. As with all electronic evaluation tools, only qualified personnel knowledgeable in electronic measurement and diagnostics normally found in development environments should use these EVMs.

Agreement to Defend, Indemnify and Hold Harmless. You agree to defend, indemnify and hold TI, its licensors and their representatives harmless from and against any and all claims, damages, losses, expenses, costs and liabilities (collectively, "Claims") arising out of or in connection with any use of the EVM that is not in accordance with the terms of the agreement. This obligation shall apply whether Claims arise under law of tort or contract or any other legal theory, and even if the EVM fails to perform as described or expected.

Safety-Critical or Life-Critical Applications. If you intend to evaluate the components for possible use in safety critical applications (such as life support) where a failure of the TI product would reasonably be expected to cause severe personal injury or death, such as devices which are classified as FDA Class III or similar classification, then you must specifically notify TI of such intent and enter into a separate Assurance and Indemnity Agreement.

Mailing Address: Texas Instruments, Post Office Box 655303, Dallas, Texas 75265
Copyright © 2012, Texas Instruments Incorporated

EVALUATION BOARD/KIT/MODULE (EVM) ADDITIONAL TERMS

Texas Instruments (TI) provides the enclosed Evaluation Board/Kit/Module (EVM) under the following conditions:

The user assumes all responsibility and liability for proper and safe handling of the goods. Further, the user indemnifies TI from all claims arising from the handling or use of the goods.

Should this evaluation board/kit not meet the specifications indicated in the User's Guide, the board/kit may be returned within 30 days from the date of delivery for a full refund. THE FOREGOING LIMITED WARRANTY IS THE EXCLUSIVE WARRANTY MADE BY SELLER TO BUYER AND IS IN LIEU OF ALL OTHER WARRANTIES, EXPRESSED, IMPLIED, OR STATUTORY, INCLUDING ANY WARRANTY OF MERCHANTABILITY OR FITNESS FOR ANY PARTICULAR PURPOSE. EXCEPT TO THE EXTENT OF THE INDEMNITY SET FORTH ABOVE, NEITHER PARTY SHALL BE LIABLE TO THE OTHER FOR ANY INDIRECT, SPECIAL, INCIDENTAL, OR CONSEQUENTIAL DAMAGES.

Please read the User's Guide and, specifically, the Warnings and Restrictions notice in the User's Guide prior to handling the product. This notice contains important safety information about temperatures and voltages. For additional information on TI's environmental and/or safety programs, please visit www.ti.com/esh or contact TI.

No license is granted under any patent right or other intellectual property right of TI covering or relating to any machine, process, or combination in which such TI products or services might be or are used. TI currently deals with a variety of customers for products, and therefore our arrangement with the user is not exclusive. TI assumes no liability for applications assistance, customer product design, software performance, or infringement of patents or services described herein.

REGULATORY COMPLIANCE INFORMATION

As noted in the EVM User's Guide and/or EVM itself, this EVM and/or accompanying hardware may or may not be subject to the Federal Communications Commission (FCC) and Industry Canada (IC) rules.

For EVMs **not** subject to the above rules, this evaluation board/kit/module is intended for use for ENGINEERING DEVELOPMENT, DEMONSTRATION OR EVALUATION PURPOSES ONLY and is not considered by TI to be a finished end product fit for general consumer use. It generates, uses, and can radiate radio frequency energy and has not been tested for compliance with the limits of computing devices pursuant to part 15 of FCC or ICES-003 rules, which are designed to provide reasonable protection against radio frequency interference. Operation of the equipment may cause interference with radio communications, in which case the user at his own expense will be required to take whatever measures may be required to correct this interference.

General Statement for EVMs including a radio

User Power/Frequency Use Obligations: This radio is intended for development/professional use only in legally allocated frequency and power limits. Any use of radio frequencies and/or power availability of this EVM and its development application(s) must comply with local laws governing radio spectrum allocation and power limits for this evaluation module. It is the user's sole responsibility to only operate this radio in legally acceptable frequency space and within legally mandated power limitations. Any exceptions to this are strictly prohibited and unauthorized by Texas Instruments unless user has obtained appropriate experimental/development licenses from local regulatory authorities, which is responsibility of user including its acceptable authorization.

For EVMs annotated as FCC – FEDERAL COMMUNICATIONS COMMISSION Part 15 Compliant

Caution

This device complies with part 15 of the FCC Rules. Operation is subject to the following two conditions: (1) This device may not cause harmful interference, and (2) this device must accept any interference received, including interference that may cause undesired operation.

Changes or modifications not expressly approved by the party responsible for compliance could void the user's authority to operate the equipment.

FCC Interference Statement for Class A EVM devices

This equipment has been tested and found to comply with the limits for a Class A digital device, pursuant to part 15 of the FCC Rules. These limits are designed to provide reasonable protection against harmful interference when the equipment is operated in a commercial environment. This equipment generates, uses, and can radiate radio frequency energy and, if not installed and used in accordance with the instruction manual, may cause harmful interference to radio communications. Operation of this equipment in a residential area is likely to cause harmful interference in which case the user will be required to correct the interference at his own expense.

FCC Interference Statement for Class B EVM devices

This equipment has been tested and found to comply with the limits for a Class B digital device, pursuant to part 15 of the FCC Rules. These limits are designed to provide reasonable protection against harmful interference in a residential installation. This equipment generates, uses and can radiate radio frequency energy and, if not installed and used in accordance with the instructions, may cause harmful interference to radio communications. However, there is no guarantee that interference will not occur in a particular installation. If this equipment does cause harmful interference to radio or television reception, which can be determined by turning the equipment off and on, the user is encouraged to try to correct the interference by one or more of the following measures:

- Reorient or relocate the receiving antenna.
- Increase the separation between the equipment and receiver.
- Connect the equipment into an outlet on a circuit different from that to which the receiver is connected.
- Consult the dealer or an experienced radio/TV technician for help.

For EVMs annotated as IC – INDUSTRY CANADA Compliant

This Class A or B digital apparatus complies with Canadian ICES-003.

Changes or modifications not expressly approved by the party responsible for compliance could void the user's authority to operate the equipment.

Concerning EVMs including radio transmitters

This device complies with Industry Canada licence-exempt RSS standard(s). Operation is subject to the following two conditions: (1) this device may not cause interference, and (2) this device must accept any interference, including interference that may cause undesired operation of the device.

Concerning EVMs including detachable antennas

Under Industry Canada regulations, this radio transmitter may only operate using an antenna of a type and maximum (or lesser) gain approved for the transmitter by Industry Canada. To reduce potential radio interference to other users, the antenna type and its gain should be so chosen that the equivalent isotropically radiated power (e.i.r.p.) is not more than that necessary for successful communication.

This radio transmitter has been approved by Industry Canada to operate with the antenna types listed in the user guide with the maximum permissible gain and required antenna impedance for each antenna type indicated. Antenna types not included in this list, having a gain greater than the maximum gain indicated for that type, are strictly prohibited for use with this device.

Cet appareil numérique de la classe A ou B est conforme à la norme NMB-003 du Canada.

Les changements ou les modifications pas expressément approuvés par la partie responsable de la conformité ont pu vider l'autorité de l'utilisateur pour actionner l'équipement.

Concernant les EVMs avec appareils radio

Le présent appareil est conforme aux CNR d'Industrie Canada applicables aux appareils radio exempts de licence. L'exploitation est autorisée aux deux conditions suivantes : (1) l'appareil ne doit pas produire de brouillage, et (2) l'utilisateur de l'appareil doit accepter tout brouillage radioélectrique subi, même si le brouillage est susceptible d'en compromettre le fonctionnement.

Concernant les EVMs avec antennes détachables

Conformément à la réglementation d'Industrie Canada, le présent émetteur radio peut fonctionner avec une antenne d'un type et d'un gain maximal (ou inférieur) approuvé pour l'émetteur par Industrie Canada. Dans le but de réduire les risques de brouillage radioélectrique à l'intention des autres utilisateurs, il faut choisir le type d'antenne et son gain de sorte que la puissance isotrope rayonnée équivalente (p.i.r.e.) ne dépasse pas l'intensité nécessaire à l'établissement d'une communication satisfaisante.

Le présent émetteur radio a été approuvé par Industrie Canada pour fonctionner avec les types d'antenne énumérés dans le manuel d'usage et ayant un gain admissible maximal et l'impédance requise pour chaque type d'antenne. Les types d'antenne non inclus dans cette liste, ou dont le gain est supérieur au gain maximal indiqué, sont strictement interdits pour l'exploitation de l'émetteur.

【Important Notice for Users of this Product in Japan】

This development kit is NOT certified as Confirming to Technical Regulations of Radio Law of Japan

If you use this product in Japan, you are required by Radio Law of Japan to follow the instructions below with respect to this product:

1. Use this product in a shielded room or any other test facility as defined in the notification #173 issued by Ministry of Internal Affairs and Communications on March 28, 2006, based on Sub-section 1.1 of Article 6 of the Ministry's Rule for Enforcement of Radio Law of Japan,
2. Use this product only after you obtained the license of Test Radio Station as provided in Radio Law of Japan with respect to this product, or
3. Use of this product only after you obtained the Technical Regulations Conformity Certification as provided in Radio Law of Japan with respect to this product. Also, please do not transfer this product, unless you give the same notice above to the transferee. Please note that if you could not follow the instructions above, you will be subject to penalties of Radio Law of Japan.

Texas Instruments Japan Limited
(address) 24-1, Nishi-Shinjuku 6 chome, Shinjuku-ku, Tokyo, Japan

<http://www.tij.co.jp>

【ご使用にあたっての注】

本開発キットは技術基準適合証明を受けておりません。

本製品のご使用に際しては、電波法遵守のため、以下のいずれかの措置を取っていただく必要がありますのでご注意ください。

1. 電波法施行規則第6条第1項第1号に基づく平成18年3月28日総務省告示第173号で定められた電波暗室等の試験設備でご使用いただく。
2. 実験局の免許を取得後ご使用いただく。
3. 技術基準適合証明を取得後ご使用いただく。

なお、本製品は、上記の「ご使用にあたっての注意」を譲渡先、移転先に通知しない限り、譲渡、移転できないものとします。

上記を遵守頂けない場合は、電波法の罰則が適用される可能性があることをご留意ください。

日本テキサス・インスツルメンツ株式会社
東京都新宿区西新宿6丁目24番1号
西新宿三井ビル

<http://www.tij.co.jp>

EVALUATION BOARD/KIT/MODULE (EVM) WARNINGS, RESTRICTIONS AND DISCLAIMERS

For Feasibility Evaluation Only, in Laboratory/Development Environments. Unless otherwise indicated, this EVM is not a finished electrical equipment and not intended for consumer use. It is intended solely for use for preliminary feasibility evaluation in laboratory/development environments by technically qualified electronics experts who are familiar with the dangers and application risks associated with handling electrical mechanical components, systems and subsystems. It should not be used as all or part of a finished end product.

Your Sole Responsibility and Risk. You acknowledge, represent and agree that:

1. You have unique knowledge concerning Federal, State and local regulatory requirements (including but not limited to Food and Drug Administration regulations, if applicable) which relate to your products and which relate to your use (and/or that of your employees, affiliates, contractors or designees) of the EVM for evaluation, testing and other purposes.
2. You have full and exclusive responsibility to assure the safety and compliance of your products with all such laws and other applicable regulatory requirements, and also to assure the safety of any activities to be conducted by you and/or your employees, affiliates, contractors or designees, using the EVM. Further, you are responsible to assure that any interfaces (electronic and/or mechanical) between the EVM and any human body are designed with suitable isolation and means to safely limit accessible leakage currents to minimize the risk of electrical shock hazard.
3. You will employ reasonable safeguards to ensure that your use of the EVM will not result in any property damage, injury or death, even if the EVM should fail to perform as described or expected.
4. You will take care of proper disposal and recycling of the EVM's electronic components and packing materials.

Certain Instructions. It is important to operate this EVM within TI's recommended specifications and environmental considerations per the user guidelines. Exceeding the specified EVM ratings (including but not limited to input and output voltage, current, power, and environmental ranges) may cause property damage, personal injury or death. If there are questions concerning these ratings please contact a TI field representative prior to connecting interface electronics including input power and intended loads. Any loads applied outside of the specified output range may result in unintended and/or inaccurate operation and/or possible permanent damage to the EVM and/or interface electronics. Please consult the EVM User's Guide prior to connecting any load to the EVM output. If there is uncertainty as to the load specification, please contact a TI field representative. During normal operation, some circuit components may have case temperatures greater than 60°C as long as the input and output are maintained at a normal ambient operating temperature. These components include but are not limited to linear regulators, switching transistors, pass transistors, and current sense resistors which can be identified using the EVM schematic located in the EVM User's Guide. When placing measurement probes near these devices during normal operation, please be aware that these devices may be very warm to the touch. As with all electronic evaluation tools, only qualified personnel knowledgeable in electronic measurement and diagnostics normally found in development environments should use these EVMs.

Agreement to Defend, Indemnify and Hold Harmless. You agree to defend, indemnify and hold TI, its licensors and their representatives harmless from and against any and all claims, damages, losses, expenses, costs and liabilities (collectively, "Claims") arising out of or in connection with any use of the EVM that is not in accordance with the terms of the agreement. This obligation shall apply whether Claims arise under law of tort or contract or any other legal theory, and even if the EVM fails to perform as described or expected.

Safety-Critical or Life-Critical Applications. If you intend to evaluate the components for possible use in safety critical applications (such as life support) where a failure of the TI product would reasonably be expected to cause severe personal injury or death, such as devices which are classified as FDA Class III or similar classification, then you must specifically notify TI of such intent and enter into a separate Assurance and Indemnity Agreement.

Mailing Address: Texas Instruments, Post Office Box 655303, Dallas, Texas 75265
Copyright © 2012, Texas Instruments Incorporated

IMPORTANT NOTICE

Texas Instruments Incorporated and its subsidiaries (TI) reserve the right to make corrections, enhancements, improvements and other changes to its semiconductor products and services per JESD46, latest issue, and to discontinue any product or service per JESD48, latest issue. Buyers should obtain the latest relevant information before placing orders and should verify that such information is current and complete. All semiconductor products (also referred to herein as "components") are sold subject to TI's terms and conditions of sale supplied at the time of order acknowledgment.

TI warrants performance of its components to the specifications applicable at the time of sale, in accordance with the warranty in TI's terms and conditions of sale of semiconductor products. Testing and other quality control techniques are used to the extent TI deems necessary to support this warranty. Except where mandated by applicable law, testing of all parameters of each component is not necessarily performed.

TI assumes no liability for applications assistance or the design of Buyers' products. Buyers are responsible for their products and applications using TI components. To minimize the risks associated with Buyers' products and applications, Buyers should provide adequate design and operating safeguards.

TI does not warrant or represent that any license, either express or implied, is granted under any patent right, copyright, mask work right, or other intellectual property right relating to any combination, machine, or process in which TI components or services are used. Information published by TI regarding third-party products or services does not constitute a license to use such products or services or a warranty or endorsement thereof. Use of such information may require a license from a third party under the patents or other intellectual property of the third party, or a license from TI under the patents or other intellectual property of TI.

Reproduction of significant portions of TI information in TI data books or data sheets is permissible only if reproduction is without alteration and is accompanied by all associated warranties, conditions, limitations, and notices. TI is not responsible or liable for such altered documentation. Information of third parties may be subject to additional restrictions.

Resale of TI components or services with statements different from or beyond the parameters stated by TI for that component or service voids all express and any implied warranties for the associated TI component or service and is an unfair and deceptive business practice. TI is not responsible or liable for any such statements.

Buyer acknowledges and agrees that it is solely responsible for compliance with all legal, regulatory and safety-related requirements concerning its products, and any use of TI components in its applications, notwithstanding any applications-related information or support that may be provided by TI. Buyer represents and agrees that it has all the necessary expertise to create and implement safeguards which anticipate dangerous consequences of failures, monitor failures and their consequences, lessen the likelihood of failures that might cause harm and take appropriate remedial actions. Buyer will fully indemnify TI and its representatives against any damages arising out of the use of any TI components in safety-critical applications.

In some cases, TI components may be promoted specifically to facilitate safety-related applications. With such components, TI's goal is to help enable customers to design and create their own end-product solutions that meet applicable functional safety standards and requirements. Nonetheless, such components are subject to these terms.

No TI components are authorized for use in FDA Class III (or similar life-critical medical equipment) unless authorized officers of the parties have executed a special agreement specifically governing such use.

Only those TI components which TI has specifically designated as military grade or "enhanced plastic" are designed and intended for use in military/aerospace applications or environments. Buyer acknowledges and agrees that any military or aerospace use of TI components which have **not** been so designated is solely at the Buyer's risk, and that Buyer is solely responsible for compliance with all legal and regulatory requirements in connection with such use.

TI has specifically designated certain components which meet ISO/TS16949 requirements, mainly for automotive use. Components which have not been so designated are neither designed nor intended for automotive use; and TI will not be responsible for any failure of such components to meet such requirements.

Products

Audio	www.ti.com/audio
Amplifiers	amplifier.ti.com
Data Converters	dataconverter.ti.com
DLP® Products	www.dlp.com
DSP	dsp.ti.com
Clocks and Timers	www.ti.com/clocks
Interface	interface.ti.com
Logic	logic.ti.com
Power Mgmt	power.ti.com
Microcontrollers	microcontroller.ti.com
RFID	www.ti-rfid.com
OMAP Applications Processors	www.ti.com/omap
Wireless Connectivity	www.ti.com/wirelessconnectivity

Applications

Automotive and Transportation	www.ti.com/automotive
Communications and Telecom	www.ti.com/communications
Computers and Peripherals	www.ti.com/computers
Consumer Electronics	www.ti.com/consumer-apps
Energy and Lighting	www.ti.com/energy
Industrial	www.ti.com/industrial
Medical	www.ti.com/medical
Security	www.ti.com/security
Space, Avionics and Defense	www.ti.com/space-avionics-defense
Video and Imaging	www.ti.com/video
TI E2E Community	e2e.ti.com