



## High Quality Audio Dual Operational Amplifier

### ■ GENERAL DESCRIPTION

The **MUSES8820** is a high quality audio operational amplifier, which is optimized for high-end audio and professional audio applications.

It is the best for audio preamplifiers, active filters, and line amplifiers with excellent sound.

### ■ FEATURES

- Operating Voltage  $V_{opr} = \pm 3.5V$  to  $\pm 16V$
- Output noise  $4.5nV/\sqrt{Hz}$  at  $f=1kHz$
- Input Offset Voltage  $0.3mV$  typ.  $3mV$  max.
- Input Bias Current  $100nA$  typ.  $500nA$  max. at  $T_a=25^\circ C$
- Voltage Gain  $110dB$  typ.
- Slew Rate  $5V/\mu s$  typ.
- Bipolar Technology
- Package Outline DIP8, SOP8 JEDEC 150mil

### ■ PACKAGE OUTLINE

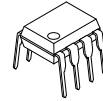

**MUSES8820D**  
(DIP8)



**MUSES8820E**  
(SOP8)

### ■ PIN CONFIGURATION

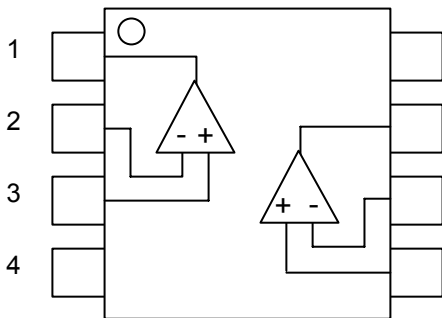

#### PIN FUNCTION

- 8 1. A OUTPUT
- 7 2. A -INPUT
- 6 3. A +INPUT
- 5 4. V-
- 4 5. B +INPUT
- 3 6. B -INPUT
- 2 7. B OUTPUT
- 1 8. V+



MUSES and this logo are trademarks of New Japan Radio Co., Ltd.

# MUSES8820

## ■ ABSOLUTE MAXIMUM RATINGS (Ta=25°C)

PARAMETER	SYMBOL	RATING	UNIT
Supply Voltage	$V^+ / V^-$	±18	V
Common Mode Input Voltage	$V_{ICM}$	±15 (Note1)	V
Differential Input Voltage	$V_{ID}$	±30	V
Power Dissipation	$P_D$	DIP8 : 870 SOP8 : 900(Note2)	mW
Output Current	$I_O$	±50	mA
Operating Temperature Range	$T_{opr}$	-40 to +85	°C
Storage Temperature Range	$T_{stg}$	-50 to +150	°C

(Note1) For supply Voltages less than ±15 V, the maximum input voltage is equal to the Supply Voltage.

(Note2) Mounted on the EIA/JEDEC standard board (114.3×76.2×1.6mm, two layer, FR-4).

## ■ RECOMMENDED OPERATING CONDITION (Ta=25°C)

PARAMETER	SYMBOL	TEST CONDITION	MIN.	TYP.	MAX.	UNIT
Supply Voltage	$V^+ / V^-$	-	±3.5	-	±16	V

## ■ ELECTRIC CHARACTERISTICS

DC CHARACTERISTICS ( $V^+ / V^- = \pm 15V$ , Ta=25°C unless otherwise specified)

PARAMETER	SYMBOL	TEST CONDITION	MIN.	TYP.	MAX.	UNIT
Operating Current	$I_{cc}$	No Signal, $R_L = \infty$	-	8.0	12.0	mA
Input Offset Voltage	$V_{IO}$	$R_s \leq 10k\Omega$ (Note3, 4)	-	0.3	3.0	mV
Input Bias Current	$I_B$	(Note3, 4)	-	100	500	nA
Input Offset Current	$I_{IO}$	(Note3, 4)	-	5	200	nA
Voltage Gain	$A_V$	$R_L \geq 2k\Omega$ , $V_o = \pm 10V$ $R_s \leq 10k\Omega$	90	110	-	dB
Common Mode Rejection Ratio	CMR	$V_{ICM} = \pm 12V$ (Note5) $R_s \leq 10k\Omega$	80	110	-	dB
Supply Voltage Rejection Ratio	SVR	$V^+ / V^- = \pm 3.5$ to $\pm 16.0V$ $R_s \leq 10k\Omega$ (Note3, 6)	80	110	-	dB
Max Output Voltage	$V_{OM}$	$R_L = 2k\Omega$	±12	±13.5	-	V
Input Common Mode Voltage Range	$V_{ICM}$	CMR ≥ 80dB	±12	±13.5	-	V

(Note3) Measured at  $V_{ICM} = 0V$

(Note4) Written by the absolute rate.

(Note5) CMR is calculated by specified change in offset voltage. ( $V_{ICM} = 0V$  to +12V and  $V_{ICM} = 0V$  to -12V)

(Note6) SVR is calculated by specified change in offset voltage. ( $V^+ / V^- = \pm 3.5V$  to  $\pm 16V$ )

AC CHARACTERISTICS ( $V^+V^- = \pm 15V$ ,  $T_a = 25^\circ C$  unless otherwise specified)

PARAMETER	SYMBOL	TEST CONDITION	MIN.	TYP.	MAX.	UNIT
Gain Bandwidth Product	GB	f=10kHz	-	11	-	MHz
Unity Gain Frequency	$f_T$	$A_V = +100$ , $R_S = 100\Omega$ , $R_L = 2k\Omega$ , $C_L = 10pF$	-	5.8	-	MHz
Phase Margin	$\phi_M$	$A_V = +100$ , $R_S = 100\Omega$ , $R_L = 2k\Omega$ , $C_L = 10pF$	-	48	-	deg
Input Noise Voltage1	$V_{NI}$	f=1kHz, $A_V = +100$ , $R_S = 100\Omega$ , $R_L = \infty$	-	4.5	-	nV/ $\sqrt{Hz}$
Input Noise Voltage2	$V_{N2}$	f=1kHz, $A_V = +10$ $R_S = 2.2k\Omega$ , RIAA, 30kHz LPF	-	0.8	1.4	$\mu V_{rms}$
Total Harmonic Distortion	THD	f=1kHz, $A_V = +10$ , $R_L = 2k\Omega$ , $V_o = 5V_{rms}$	-	0.001	-	%
Channel Separation	CS	f=1kHz, $A_V = -+100$ , $R_S = 1k\Omega$ , $R_L = 2k\Omega$	-	140	-	dB
Positive Slew Rate	+SR	$A_V = 1$ , $V_{IN} = 2V_{p-p}$ , $R_L = 2k\Omega$ , $C_L = 10pF$	-	5	-	V/ $\mu s$
Negative Slew Rate	-SR	$A_V = 1$ , $V_{IN} = 2V_{p-p}$ , $R_L = 2k\Omega$ , $C_L = 10pF$	-	5	-	V/ $\mu s$

## ■ Application Notes

### •Package Power, Power Dissipation and Output Power

IC is heated by own operation and possibly gets damage when the junction power exceeds the acceptable value called Power Dissipation  $P_D$ . The dependence of the MUSES8820  $P_D$  on ambient temperature is shown in Fig 1. The plots are depended on following two points. The first is  $P_D$  on ambient temperature 25°C, which is the maximum power dissipation. The second is 0W, which means that the IC cannot radiate any more. Conforming the maximum junction temperature  $T_{jmax}$  to the storage temperature  $T_{stg}$  derives this point. Fig.1 is drawn by connecting those points and conforming the  $P_D$  lower than 25°C to it on 25°C. The  $P_D$  is shown following formula as a function of the ambient temperature between those points.

$$\text{Dissipation Power } P_D = \frac{T_{jmax} - T_a}{\theta_{ja}} \text{ [W]} \quad (T_a=25^\circ\text{C to } T_a=150^\circ\text{C})$$

Where,  $\theta_{ja}$  is heat thermal resistance which depends on parameters such as package material, frame material and so on. Therefore,  $P_D$  is different in each package.

While, the actual measurement of dissipation power on MUSES8820 is obtained using following equation.

$$(\text{Actual Dissipation Power}) = (\text{Supply Voltage } V_{DD}) \times (\text{Supply Current } I_{DD}) - (\text{Output Power } P_o)$$

The MUSES8820 should be operated in lower than  $P_D$  of the actual dissipation power.

To sustain the steady state operation, take account of the Dissipation Power and thermal design.

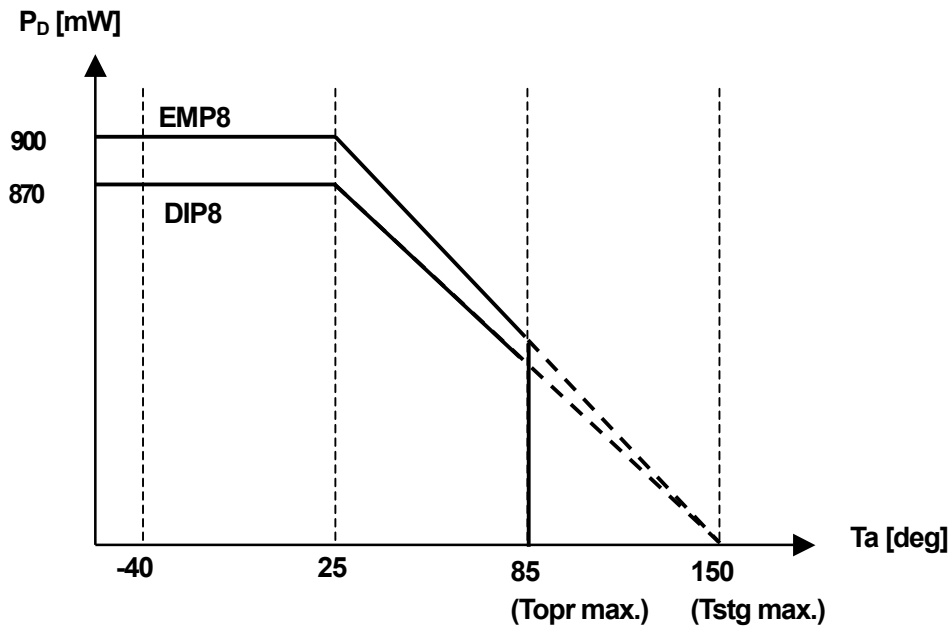
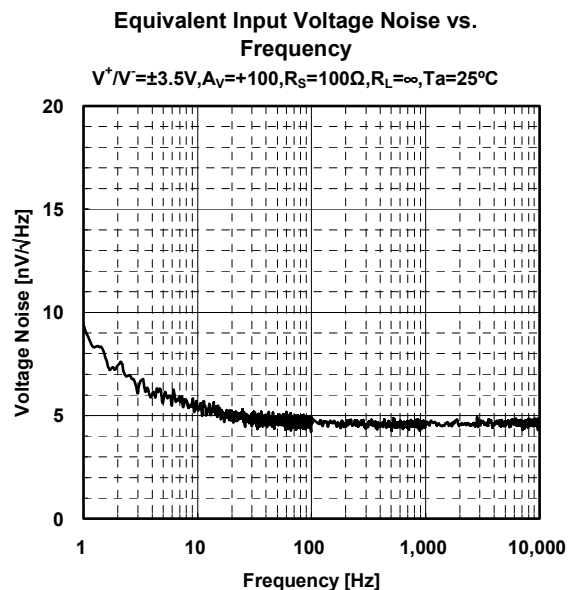
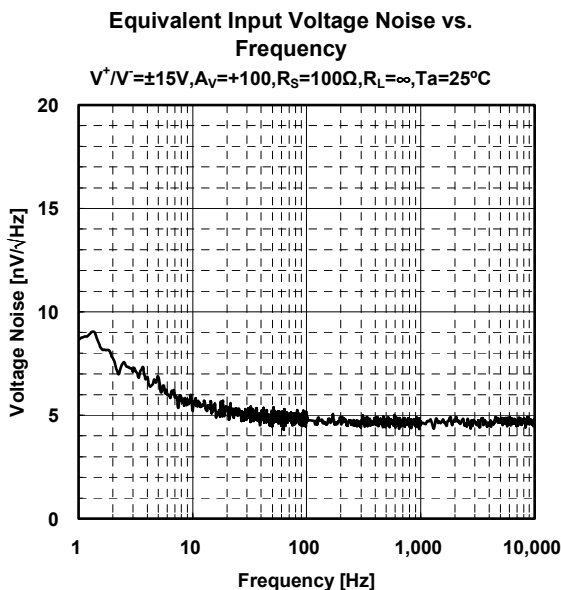
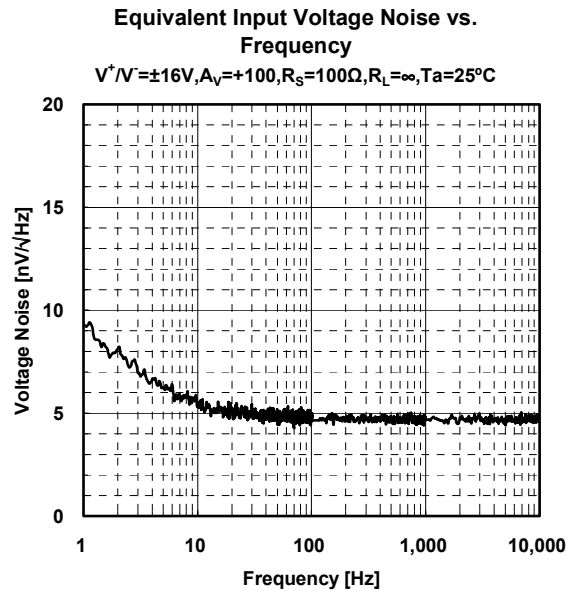
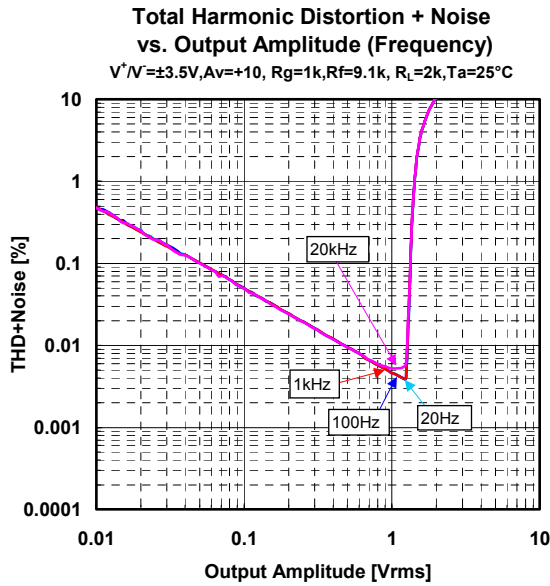
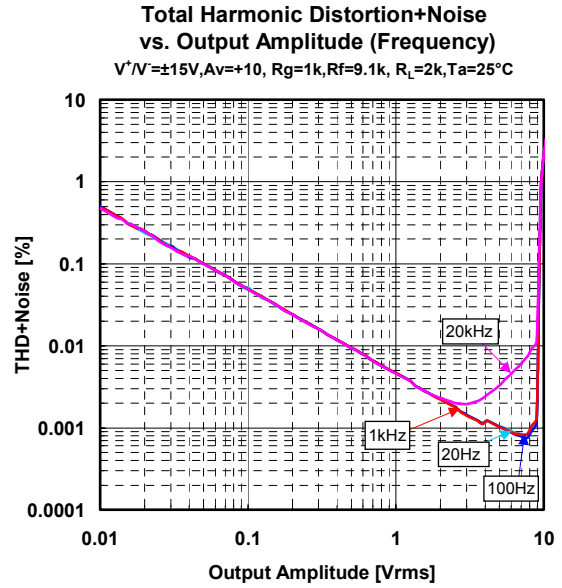
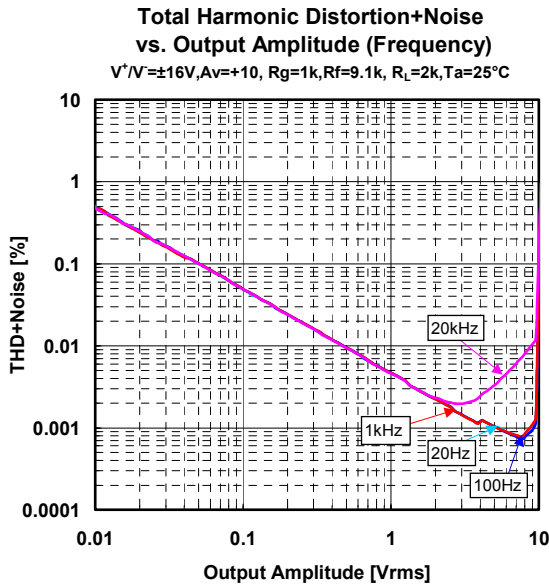
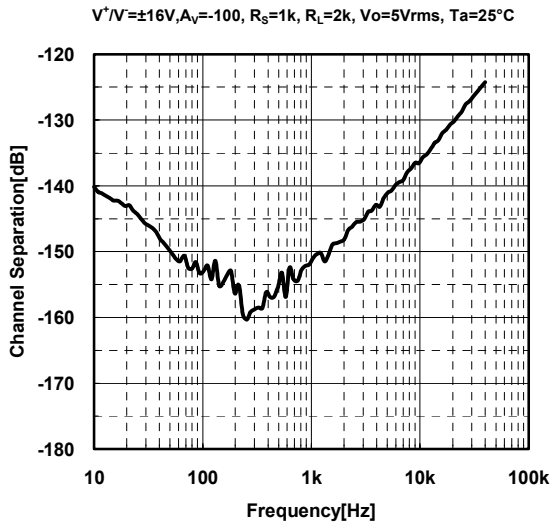

Fig.1 Power Dissipations vs. Ambient Temperature on the MUSES8820

## ■ TYPICAL CHARACTERISTICS



Channel Separation vs. Frequency



Channel Separation vs. Frequency

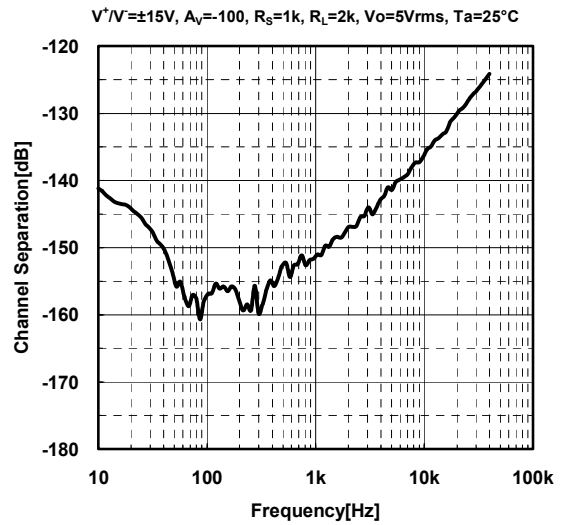

Channel Separation vs. Frequency

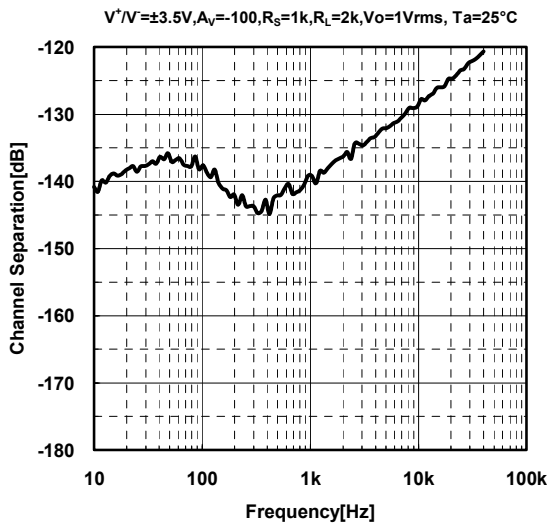

Closed-Loop Gain/Phase vs. Frequency(Temperature)

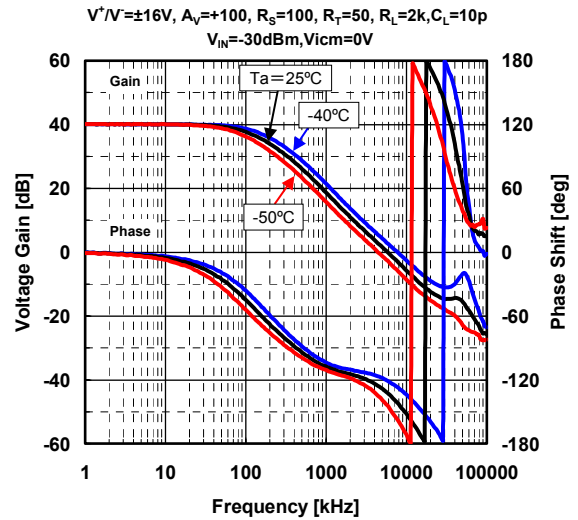

Closed-Loop Gain/Phase vs. Frequency(Temperature)

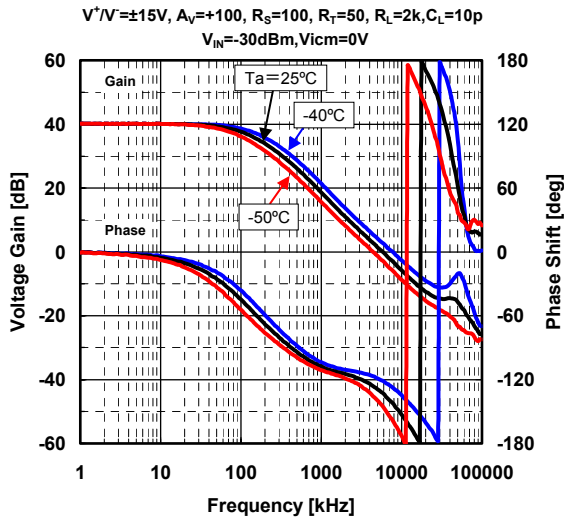

Closed-Loop Gain/Phase vs. Frequency(Temperature)

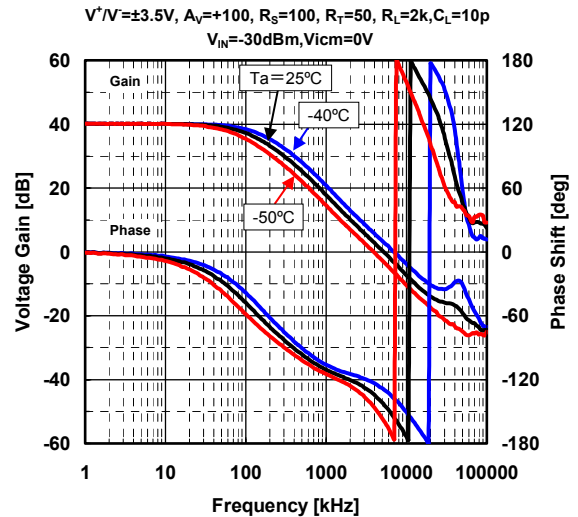

### Transient Response (Temperature)

$V^+ / V^- = \pm 16V, V_{IN} = 2V_{P-P}, f = 100kHz$   
 PulseEdge=10nsec, Gv=0dB,  $C_L = 10p, R_L = 2k$

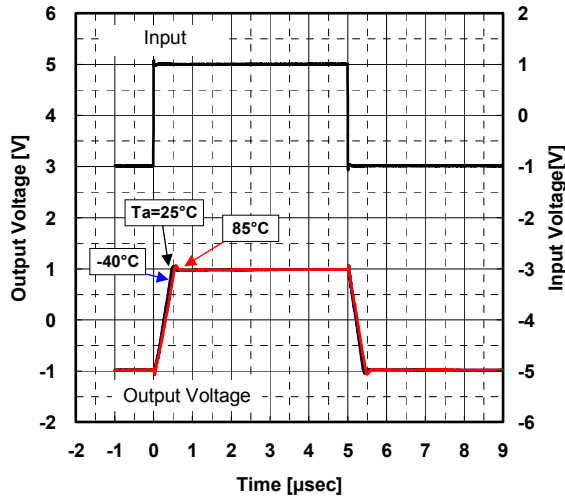

### Slew Rate vs. Temperature

$V^+ / V^- = \pm 16V, V_{IN} = 2V_{P-P}, f = 100kHz$   
 PulseEdge=10nsec, Gv=0dB,  $C_L = 10p, R_L = 2k$

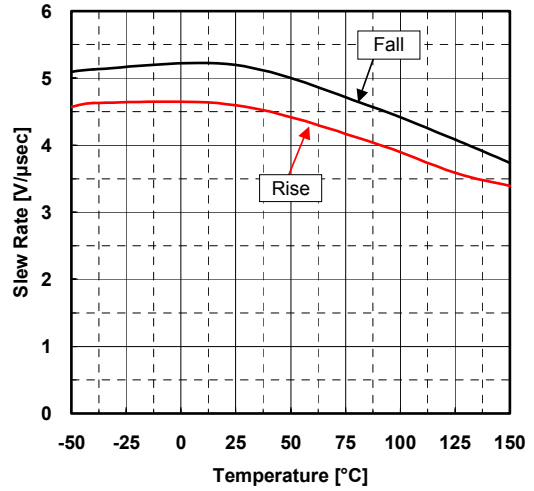

### Transient Response (Temperature)

$V^+ / V^- = \pm 15V, V_{IN} = 2V_{P-P}, f = 100kHz$   
 PulseEdge=10nsec, Gv=0dB,  $C_L = 10p, R_L = 2k$

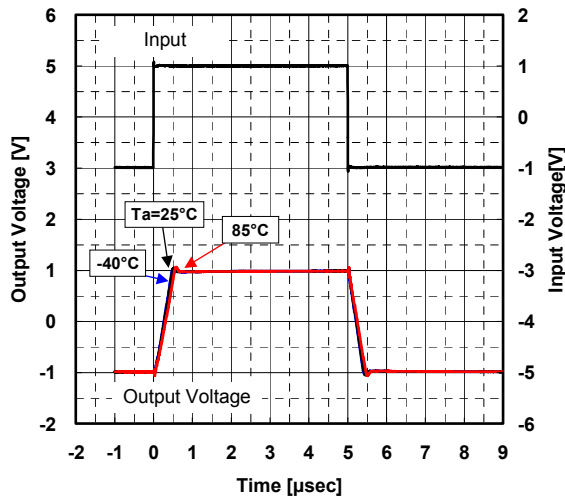

### Slew Rate vs. Temperature

$V^+ / V^- = \pm 15V, V_{IN} = 2V_{P-P}, f = 100kHz$   
 PulseEdge=10nsec, Gv=0dB,  $C_L = 10p, R_L = 2k$

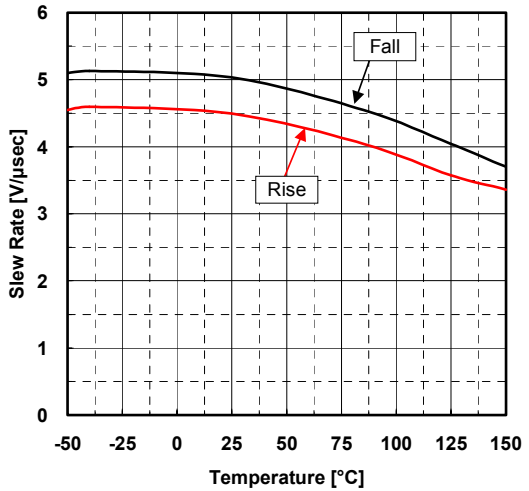

### Transient Response (Temperature)

$V^+ / V^- = \pm 3.5V, V_{IN} = 2V_{P-P}, f = 100kHz$   
 PulseEdge=10nsec, Gv=0dB,  $C_L = 10p, R_L = 2k$

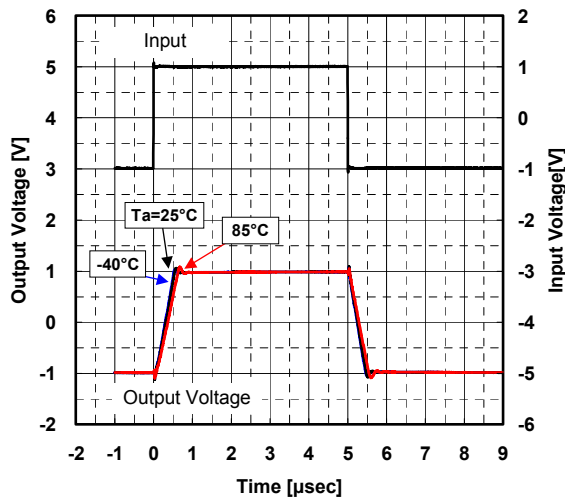

### Slew Rate vs. Temperature

$V^+ / V^- = \pm 3.5V, V_{IN} = 2V_{P-P}, f = 100kHz$   
 PulseEdge=10nsec, Gv=0dB,  $C_L = 10p, R_L = 2k$

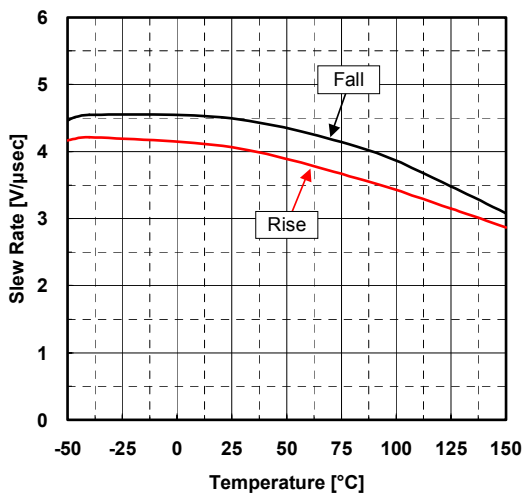

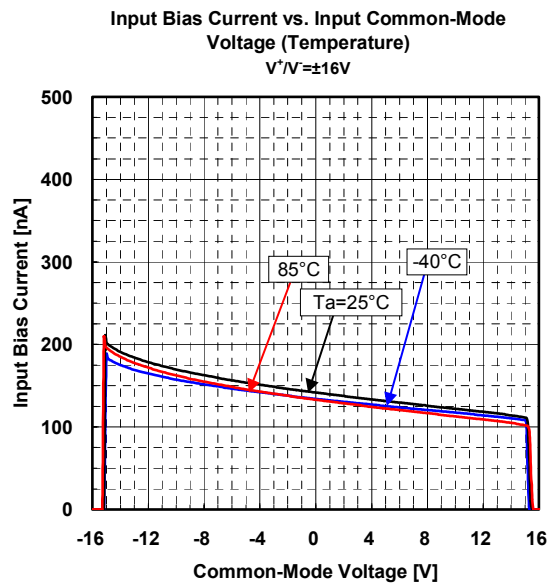
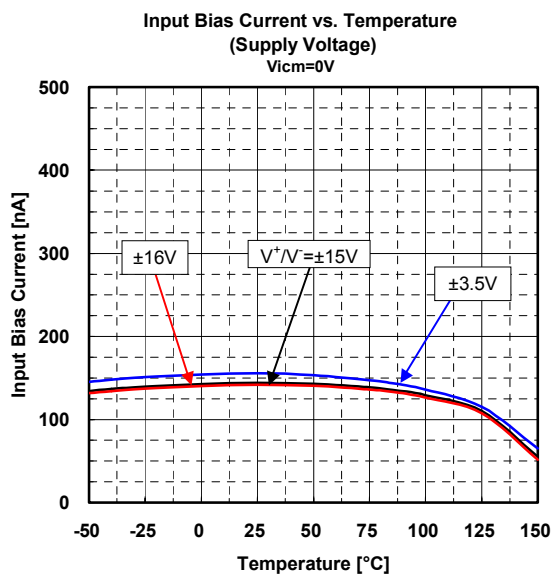
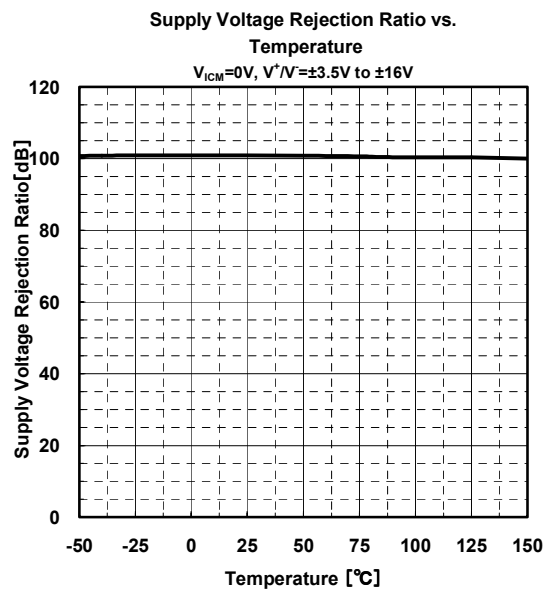
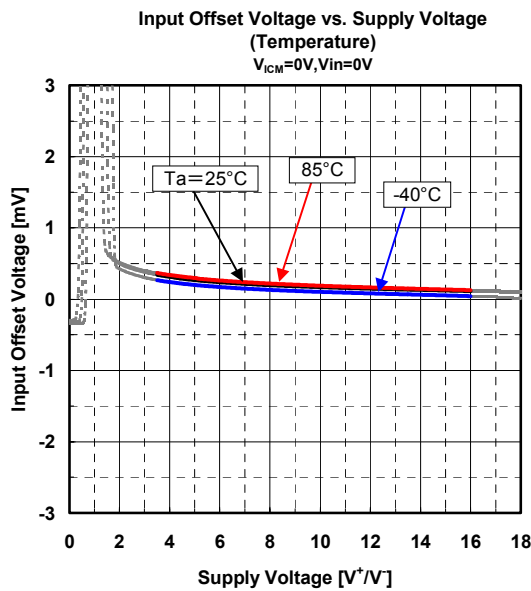
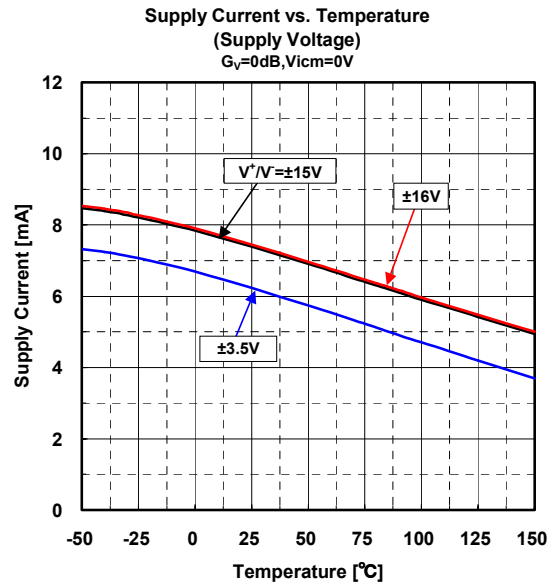
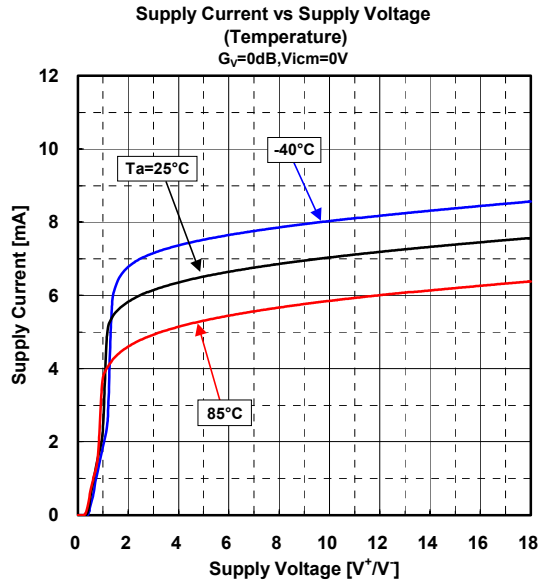



Input Bias Current vs. Input Common-Mode Voltage (Temperature)  
 $V^+ / V^- = \pm 15V$

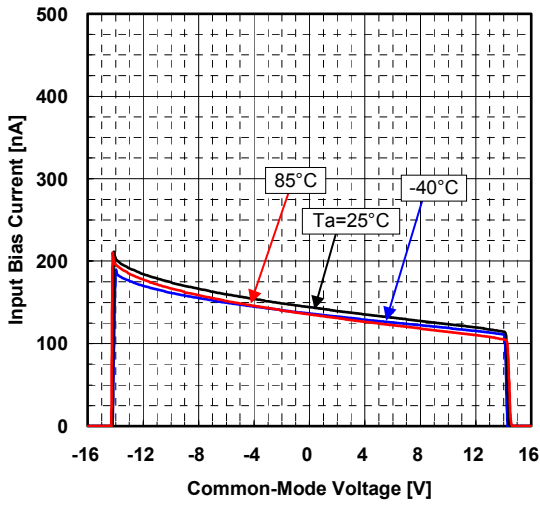

Input Bias Current vs. Input Common-Mode Voltage (Temperature)  
 $V^+ / V^- = \pm 3.5V$

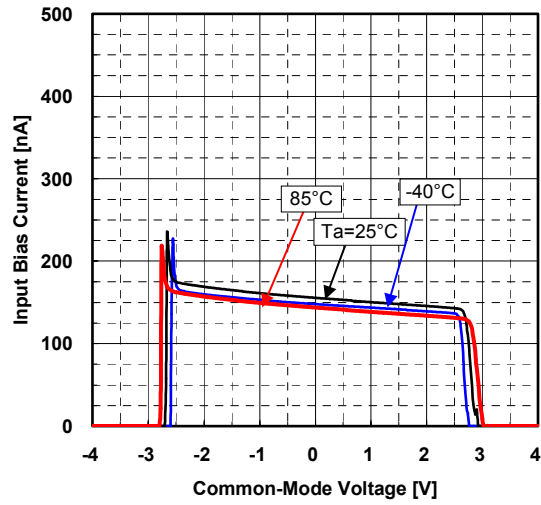

Input Offset Current vs. Temperature (Supply Voltage)  
 $V_{icm} = 0V$

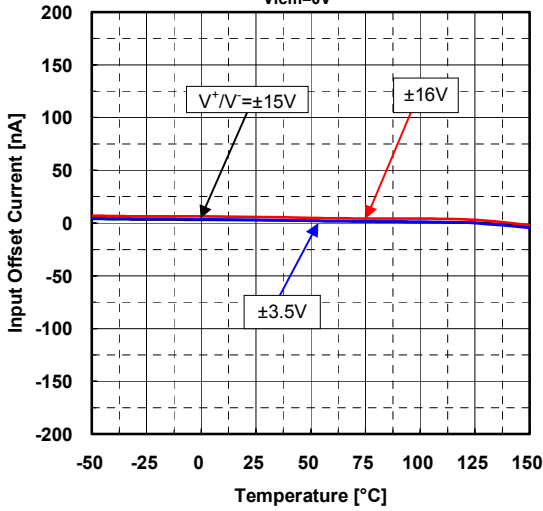

Input Offset Voltage vs. Output Voltage (Temperature)  
 $V^+ / V^- = \pm 15V, R_L = 2k\Omega$  to  $0V$

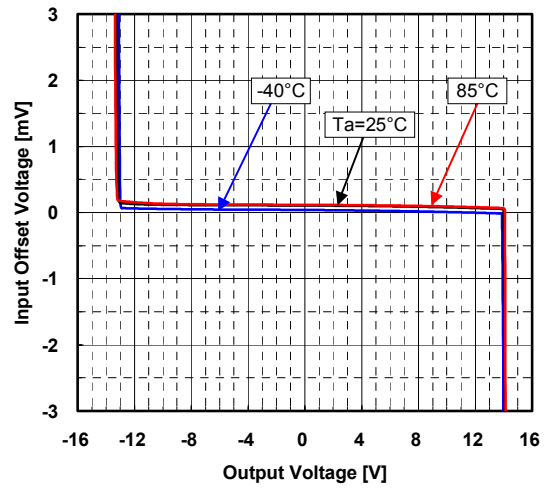

Open-Loop Voltage Gain vs. Temperature  
 $R_L = 2k\Omega$  to  $0V, V^+ / V^- = \pm 16V, V_o = -11V$  to  $+11V$

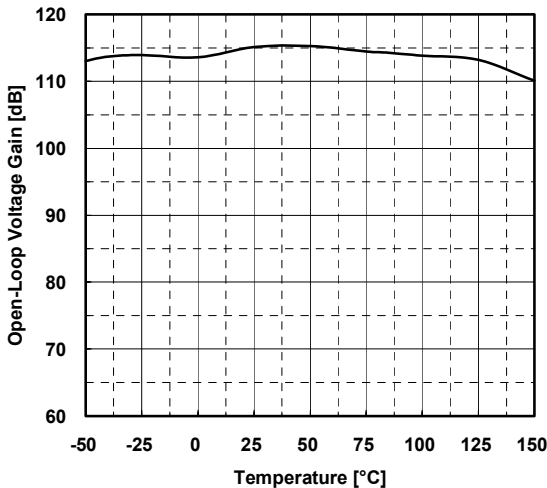

Open-Loop Voltage Gain vs. Temperature  
 $R_L = 2k\Omega$  to  $0V, V^+ / V^- = \pm 15V, V_o = -10V$  to  $+10V$

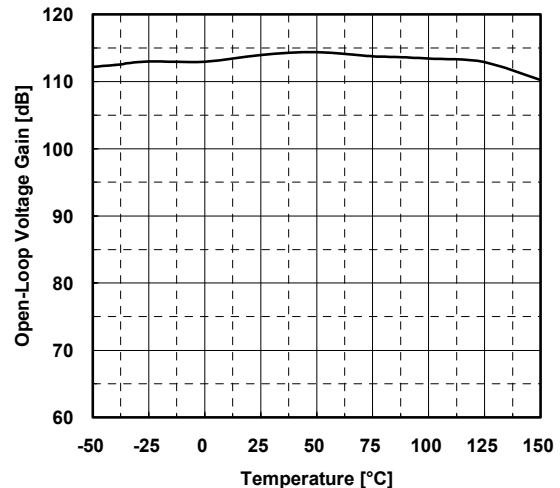

**Open-Loop Voltage Gain vs. Temperature**  
 $R_L=2k\Omega$  to 0V,  $V^+/V^-=\pm 3.5V$ ,  $V_O=-1V$  to +1V

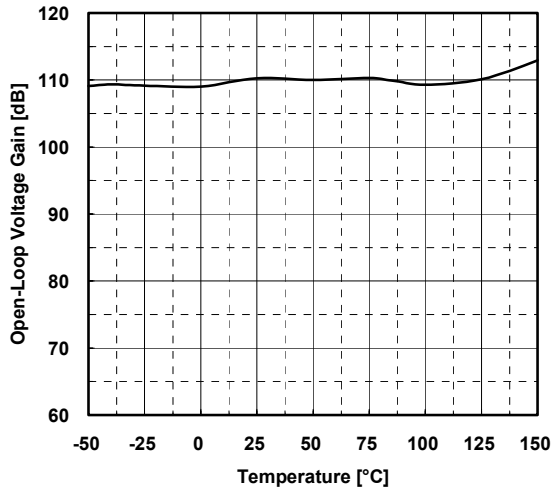

**Common-Mode Rejection Ratio vs. Temperature (Input Common-Mode Voltage)**  
 $V^+/V^-=\pm 16V$

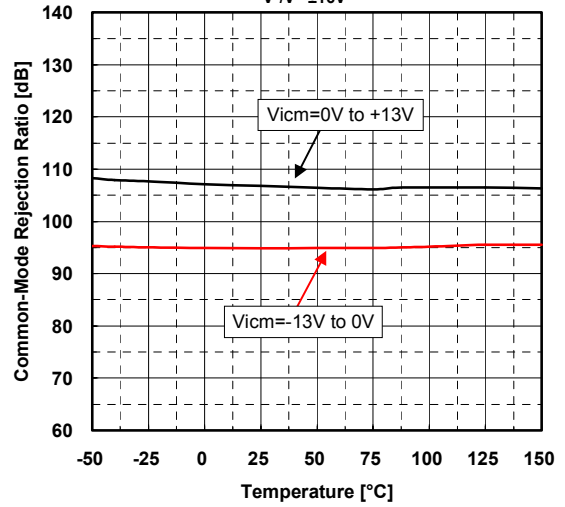

**Common-Mode Rejection Ratio vs. Temperature (Input Common-Mode Voltage)**  
 $V^+/V^-=\pm 15V$

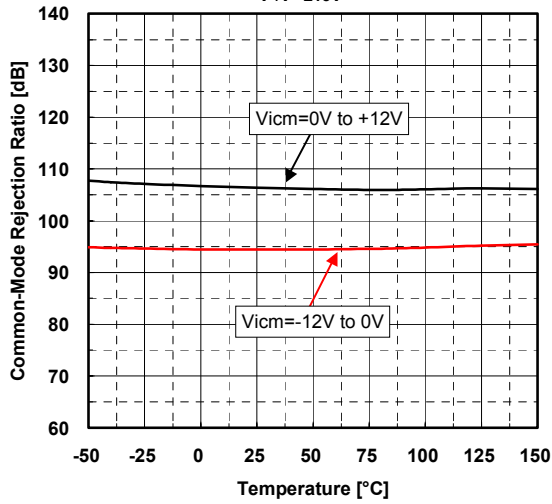

**Common-Mode Rejection Ratio vs. Temperature (Input Common-Mode Voltage)**  
 $V^+/V^-=\pm 3.5V$

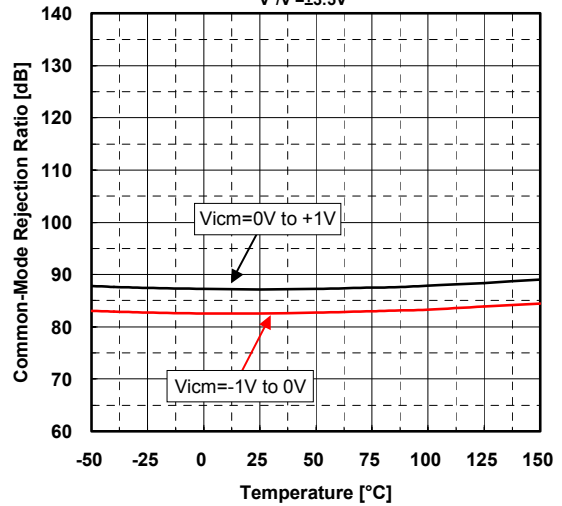

**Maximum Output Voltage vs. Load Resistance (Temperature)**  
 $V^+/V^-=\pm 16V$ ,  $G_V=open$ ,  $R_L$  to 0V

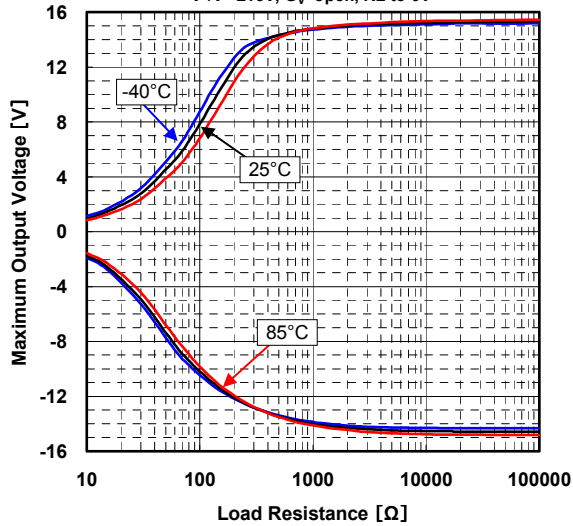

**Maximum Output Voltage vs. Load Resistance (Temperature)**  
 $V^+/V^-=\pm 15V$ ,  $G_V=open$ ,  $R_L$  to 0V

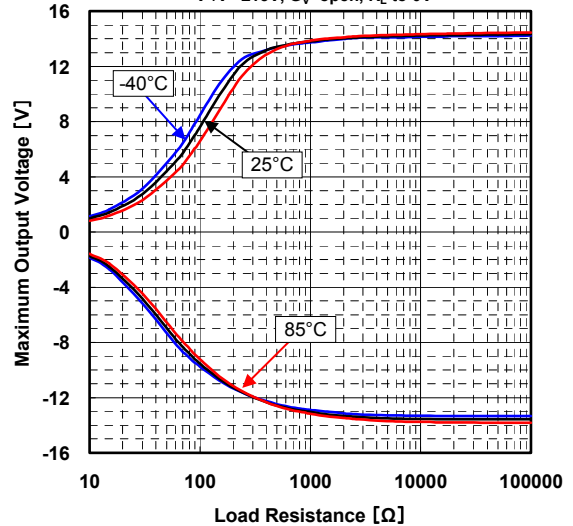

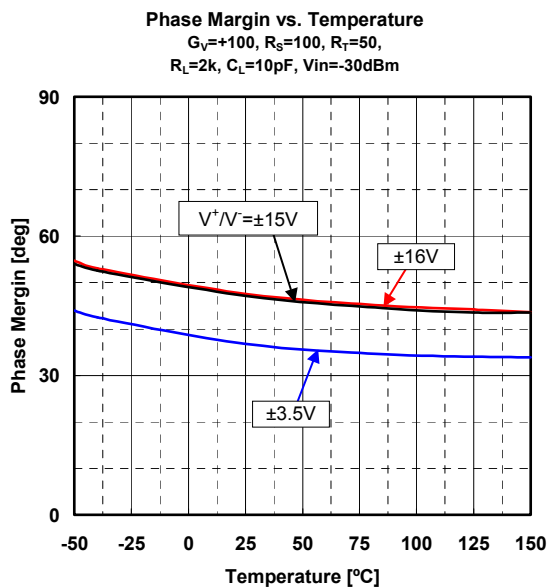
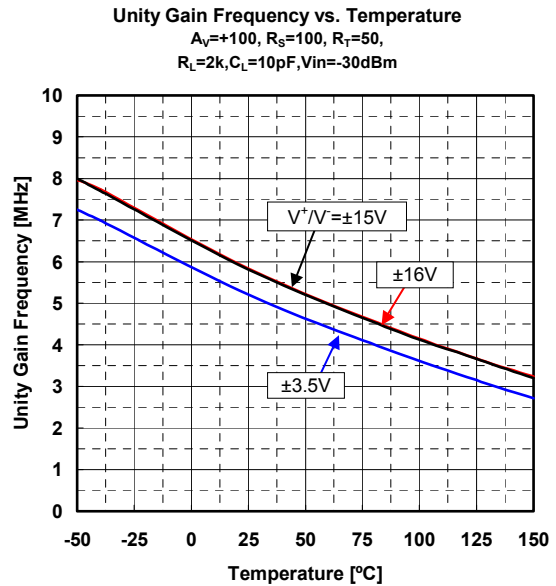
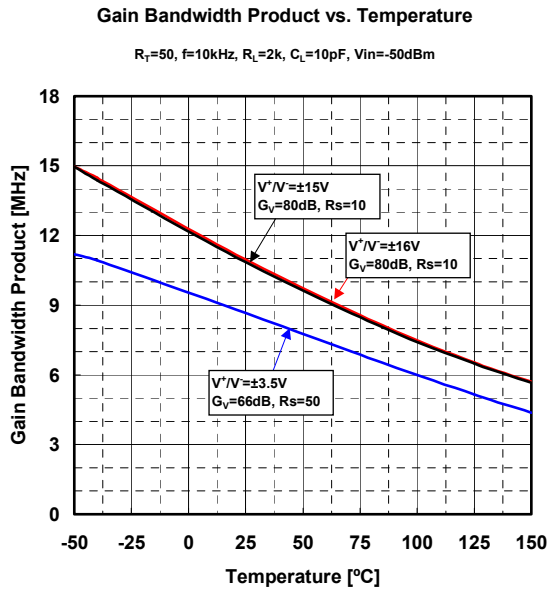
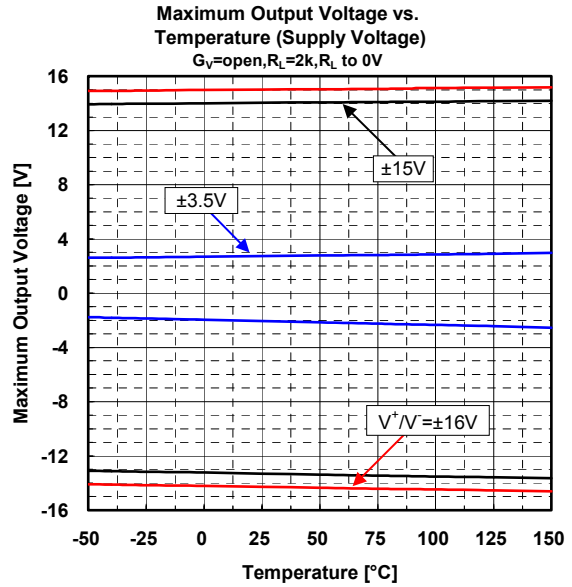
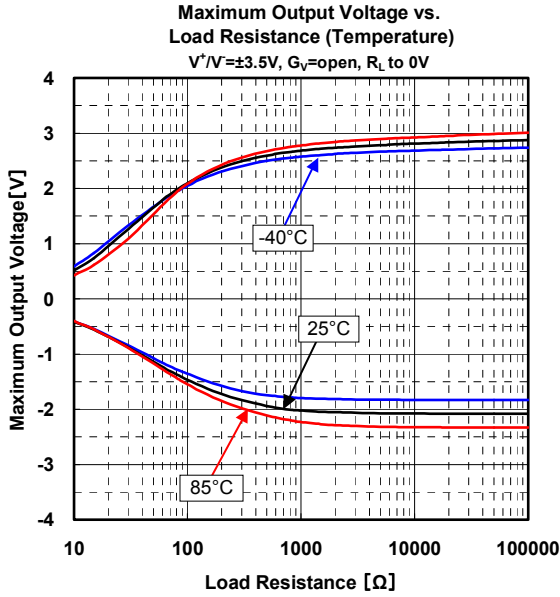

# MUSES8820

---

MEMO

[CAUTION]  
The specifications on this databook are only given for information, without any guarantee as regards either mistakes or omissions. The application circuits in this databook are described only to show representative usages of the product and not intended for the guarantee or permission of any right including the industrial rights.