

GW PN/ASCII 1E/2DB9 - Interface converters



1021058

<https://www.phoenixcontact.com/us/products/1021058>

Please be informed that the data shown in this PDF document is generated from our online catalog. Please find the complete data in the user documentation. Our general terms of use for downloads are valid.



The GW PN/ASCII... converts RAW or ASCII serial strings into PROFINET. Includes one RJ45 port and two D-SUB 9 ports.

Commercial data

Item number	1021058
Packing unit	1 pc
Sales key	DN09
Product key	DNC323
Catalog page	Page 355 (C-6-2019)
GTIN	4055626513409
Weight per piece (including packing)	184.5 g
Weight per piece (excluding packing)	184.5 g
Customs tariff number	85176200
Country of origin	US

GW PN/ASCII 1E/2DB9 - Interface converters



1021058

<https://www.phoenixcontact.com/us/products/1021058>

Technical data

Notes

Utilization restriction

EMC note	EMC: class A product, see manufacturer's declaration in the download area
----------	---

Utilization restriction

CCCex note	Use in potentially explosive areas is not permitted in China.
------------	---

Product properties

Product type	Interface converter
MTBF	69.4 Years (Telcordia standard, 25°C temperature, 50% stress, Environmental Factor = 1.0)
	46.3 Years (Telcordia standard, 40°C temperature, 50% stress, environmental factor = 1.0)

Electrical properties

Electrical isolation	IEC UL 61010-1 (VCC // Ethernet)
Test voltage data interface/data interface	1.5 kV _{rms} (50 Hz, 1 min.)
Test voltage data interface/power supply	1.5 kV _{rms} (50 Hz, 1 min.)
	1.5 kV _{rms}

Supply

Supply voltage range	10.8 V DC ... 30 V DC (via pluggable COMBICON screw terminal block)
Typical current consumption	76 mA (24 V DC)
Max. current consumption	85 mA (24 V DC)

Function

Management	Web-based management
Status and diagnostic indicators	LEDs: Status, ACT/LNK (Ethernet data traffic)

Connection data

Supply

Conductor cross section, flexible	0.20 mm ² ... 2.50 mm ²
Conductor cross section AWG	24 ... 12
Tightening torque	0.5 Nm ... 0.6 Nm

Interfaces

Signal	Ethernet
	PROFINET
Web server	yes

Data: PROFINET

Serial transmission speed	10/100 Mbps, auto negotiation
---------------------------	-------------------------------

GW PN/ASCII 1E/2DB9 - Interface converters



1021058

<https://www.phoenixcontact.com/us/products/1021058>

Connection method	RJ45 jack, shielded
No. of channels	1
Transmission length	≤ 100 m (shielded twisted pair)
Protocols supported	PROFINET, ASCII
Auxiliary protocols	ARP, DHCP (Client), PING

Data: RS-232

Serial transmission speed	0.3; 0.6; 1.2; 2.4; 4.8; 9.6; 19.2; 38.4; 57.6; 115.2; 230.4 Kbps
Number of connections	2
Connection method	D-SUB 9 plug
Pin assignment	DTE
Transmission length	15 m
File format/coding	5/6/7/8 Data bits, 1/2 Stop bits, None/Even/Odd/Mark/Space Parity
Data flow control/protocols	Software handshake, Xon/Xoff or hardware handshake RTS/CTS

Data: RS-422

Serial transmission speed	0.3; 0.6; 1.2; 2.4; 4.8; 9.6; 19.2; 38.4; 57.6; 115.2; 230.4 Kbps
Number of connections	2
Connection method	D-SUB 9 plug
Pin assignment	2, 3, 5, 7, 8
Transmission length	≤ 1200 m
Termination resistor	120 Ω (configurable)
File format/coding	5/6/7/8 Data bits, 1/2 Stop bits, None/Even/Odd/Mark/Space Parity

Data: RS-485

Serial transmission speed	0.3; 0.6; 1.2; 2.4; 4.8; 9.6; 19.2; 38.4; 57.6; 115.2; 230.4 Kbps
Number of connections	2
Connection method	D-SUB 9 plug
Pin assignment	3, 5, 7
Termination resistor	120 Ω (configurable)
File format/coding	5/6/7/8 Data bits, 1/2 Stop bits, None/Even/Odd/Mark/Space Parity

Dimensions

Width	22.5 mm
Height	99 mm
Depth	115 mm

Material specifications

Color	gray
Housing material	PA 6.6

Environmental and real-life conditions

Ambient conditions

GW PN/ASCII 1E/2DB9 - Interface converters



1021058

<https://www.phoenixcontact.com/us/products/1021058>

Degree of protection	IP20
Ambient temperature (operation)	-40 °C ... 70 °C
Ambient temperature (storage/transport)	-40 °C ... 80 °C
Altitude	< 2000 m
Permissible humidity (operation)	10 % ... 95 % (non-condensing)
Permissible humidity (storage/transport)	5 % ... 95 % (non-condensing)

Approvals

Conformity/Approvals

Conformance	CE-compliant
UL, USA	UL 61010-1
UL, USA / Canada	Class I, Div. 2, Groups A, B, C, D T4A

Ex data

ATEX	DEMKO 18ATEX 2026X: II 3 G Ex ec IIC T4 Gc
IECEX	IECEX UL 18.0023X Ex ec IIC T4 Gc

EMC data

Noise immunity	EN 61000-6-2:2005
Electromagnetic compatibility	Conformance with EMC Directive 2014/30/EU
Noise emission	EN 61000-6-4

Standards and regulations

Standards/regulations	EN 55022, EN 55024
-----------------------	--------------------

Mounting

Mounting type	DIN rail mounting
---------------	-------------------

1021058

<https://www.phoenixcontact.com/us/products/1021058>

Drawings

Block diagram

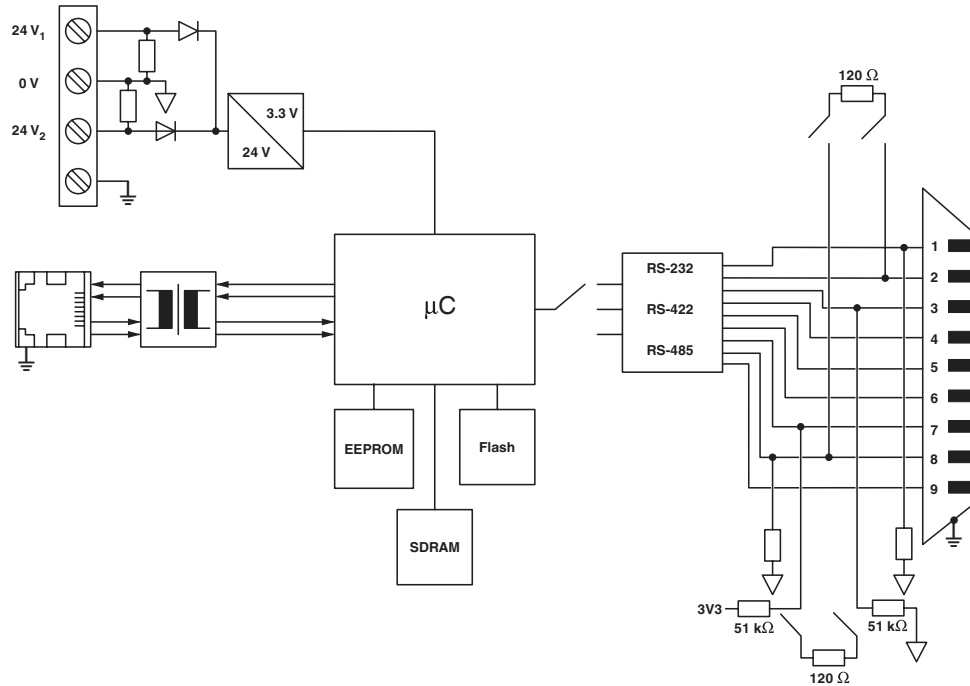



1021058

<https://www.phoenixcontact.com/us/products/1021058>

Approvals

To download certificates, visit the product detail page: <https://www.phoenixcontact.com/us/products/1021058>

 **UL Listed**
Approval ID: FILE E 238705

 **cUL Listed**
Approval ID: FILE E 238705

PROFINET
Approval ID: Z12465

 **IECEx**
Approval ID: IECEx UL 18.0023X

 **cUL Listed**
Approval ID: FILE E 196811

 **UL Listed**
Approval ID: FILE E 196811

 **ATEX**
Approval ID: DEMKO 18 ATEX 2026X

cULus Listed

cULus Listed

GW PN/ASCII 1E/2DB9 - Interface converters



1021058

<https://www.phoenixcontact.com/us/products/1021058>

Classifications

ECLASS

ECLASS-11.0	19179090
ECLASS-12.0	19179090
ECLASS-13.0	19179090

ETIM

ETIM 8.0	EC000310
----------	----------

UNSPSC

UNSPSC 21.0	43222600
-------------	----------

GW PN/ASCII 1E/2DB9 - Interface converters



1021058

<https://www.phoenixcontact.com/us/products/1021058>

Environmental product compliance

China RoHS	Environmentally Friendly Use Period = 50 years For information on hazardous substances, refer to the manufacturer's declaration available under "Downloads"
------------	--

GW PN/ASCII 1E/2DB9 - Interface converters



1021058

<https://www.phoenixcontact.com/us/products/1021058>

Accessories

PSM-KA9SUB9/BB/2METER - Data cable

2799474

<https://www.phoenixcontact.com/us/products/2799474>

RS-232 cable, 9-pos. D-SUB socket on 9-pos. D-SUB socket, 9-wire, 1:1



SUBCON 9/F-SH - D-SUB bus connector

2761499

<https://www.phoenixcontact.com/us/products/2761499>

D-SUB plug, 9-pos. female connector, one 35° cable entry, universal type for all systems, pin assignment: 1, 2, 3, 4, 5, 6, 7, 8, 9 to screw connection terminal block



GW PN/ASCII 1E/2DB9 - Interface converters



1021058

<https://www.phoenixcontact.com/us/products/1021058>

SUBCON-PLUS-F/AX 9 - D-SUB bus connector

2311797

<https://www.phoenixcontact.com/us/products/2311797>



D-SUB connector, 9-pos. female connector, axial version with two cable entries, universal type for all systems, pin assignment: 1, 2, 3, 4, 5, 6, 7, 8, 9 to screw connection terminal block

PSM-AD-D9-NULLMODEM - Adapter

2708753

<https://www.phoenixcontact.com/us/products/2708753>

V.24 (RS-232) zero modem connector



GW PN/ASCII 1E/2DB9 - Interface converters



1021058

<https://www.phoenixcontact.com/us/products/1021058>

FL CAT5 PATCH 0,5 - Patch cable

2832263

<https://www.phoenixcontact.com/us/products/2832263>

Patch cable, CAT5, assembled, 0.5 m



FL CAT5 PATCH 5,0 - Patch cable

2832580

<https://www.phoenixcontact.com/us/products/2832580>

Patch cable, CAT5, assembled, 5 m



GW PN/ASCII 1E/2DB9 - Interface converters



1021058

<https://www.phoenixcontact.com/us/products/1021058>

FL SWITCH SFN 5TX - Industrial Ethernet Switch

2891152

<https://www.phoenixcontact.com/us/products/2891152>



Ethernet switch, 5 TP RJ45 ports, automatic detection of data transmission speed of 10 or 100 Mbps (RJ45), autocrossing function

DT-LAN-CAT.6+ - Surge protection device

2881007

<https://www.phoenixcontact.com/us/products/2881007>



Surge protection in accordance with Class E_A (CAT6_A), for Gigabit Ethernet (up to 10 Gbps), token ring, FDDI/CDDI, ISDN, and DS1. Suitable for Power over Ethernet (PoE++ / 4PPoE) "Mode A" and "Mode B". RJ45 attachment plug with separate grounding cable and ground connection snap-on foot for NS 35 DIN rails.

GW PN/ASCII 1E/2DB9 - Interface converters

1021058

<https://www.phoenixcontact.com/us/products/1021058>

SUBCON-PLUS 9/F - D-SUB bus connector

2744241

<https://www.phoenixcontact.com/us/products/2744241>



D-SUB connector, 9-pos. female connector, two 35° cable entries, universal type for all systems, pin assignment: 1, 2, 3, 4, 5, 6, 7, 8, 9 to one screw connection terminal block

SUBCON-PLUS F2 - D-SUB bus connector

2799490

<https://www.phoenixcontact.com/us/products/2799490>



D-SUB connector, 9-pos. female connector, two 35° cable entries, bus system: CAN, SUCONET K1, K2 (MOELLER), S-BUS (Saia), J-BUS (Merlin Gerin), pin assignment: 2, 3, 4, 5, 7, 9 to two screw connection terminal blocks

GW PN/ASCII 1E/2DB9 - Interface converters



1021058

<https://www.phoenixcontact.com/us/products/1021058>

NBC-R4AC-R4AC-IE8A/.../... - Patch cable

1411854

<https://www.phoenixcontact.com/us/products/1411854>



Patch cable, degree of protection: IP20, number of positions: 8, 10 Gbps, CAT6_A, cable outlet: straight, Ethernet

NBC-R4AC/10G-R4AC/10G-94F/3,0 - Patch cable

1408365

<https://www.phoenixcontact.com/us/products/1408365>



Patch cable, CAT6_A, 4-pair, shielded, connection not crossed (line), assembled at both ends with RJ45/IP20 connectors, outer sheath material: PUR, length: 3.0 m

GW PN/ASCII 1E/2DB9 - Interface converters



1021058

<https://www.phoenixcontact.com/us/products/1021058>

VS-08-RJ45-5-Q/IP20 - RJ45 connector

1656725

<https://www.phoenixcontact.com/us/products/1656725>



RJ45 connector, design: RJ45, degree of protection: IP20, number of positions: 8, 1 Gbps, CAT5, material: Plastic, connection method: Insulation displacement connection, connection cross section: AWG 26- 23, cable outlet: straight, color: traffic grey A RAL 7042, Ethernet

VS-08-RJ45-10G/Q - RJ45 connector

1419001

<https://www.phoenixcontact.com/us/products/1419001>



RJ45 connector, design: RJ45, degree of protection: IP20, number of positions: 8, 10 Gbps, CAT6_A, material: Plastic, connection method: Insulation displacement connection, connection cross section: AWG 26- 24, cable outlet: straight, color: black, Ethernet

GW PN/ASCII 1E/2DB9 - Interface converters



1021058

<https://www.phoenixcontact.com/us/products/1021058>

VS-09-BU-DSUB-EG - Contact insert

1688803

<https://www.phoenixcontact.com/us/products/1688803>



D-SUB contact insert, shell size 1, with nine signal contacts, type of contact socket, with solder cup, straight, fixing with a 3 mm hole, for panel mounting frame and sleeve housing VS-09-...

VS-09-ST-DSUB-EG - Contact insert

1688793

<https://www.phoenixcontact.com/us/products/1688793>



D-SUB contact insert, shell size 1, with nine signal contacts, type of contact pin, with solder cup, straight, fixing with a 3 mm hole, for panel mounting frame and sleeve housing VS-09-...

GW PN/ASCII 1E/2DB9 - Interface converters



1021058

<https://www.phoenixcontact.com/us/products/1021058>

CUC-DST-GZNI-S/DSSC9 - D-SUB sleeve housings

1419722

<https://www.phoenixcontact.com/us/products/1419722>

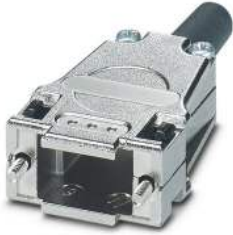

D-SUB sleeve housings, degree of protection: IP20, material: Zinc die-cast, cable outlet: straight, housing size: 1, color: Bare metallic

CUC-DST-GPME-S/DSSC9 - D-SUB sleeve housings

1419705

<https://www.phoenixcontact.com/us/products/1419705>



D-SUB sleeve housings, degree of protection: IP20, material: ABS, metal-plated, cable outlet: straight, housing size: 1, color: Bare metallic

GW PN/ASCII 1E/2DB9 - Interface converters



1021058

<https://www.phoenixcontact.com/us/products/1021058>

NBC-R4AC/1,0-93B/R4AC - Patch cable

1408968

<https://www.phoenixcontact.com/us/products/1408968>



Patch cable, degree of protection: IP20, cable length: 1 m, number of positions: 4, 100 Mbps, CAT5, material: PA 6.6, PROFINET

NBC-R4AC/2,0-93B/R4AC - Patch cable

1408969

<https://www.phoenixcontact.com/us/products/1408969>



Patch cable, degree of protection: IP20, cable length: 2 m, number of positions: 4, 100 Mbps, CAT5, material: PA 6.6, PROFINET

GW PN/ASCII 1E/2DB9 - Interface converters



1021058

<https://www.phoenixcontact.com/us/products/1021058>

VS-PN-RJ45-5-Q/IP20 - RJ45 connector

1658435

<https://www.phoenixcontact.com/us/products/1658435>



RJ45 connector, design: RJ45, degree of protection: IP20, number of positions: 4, 100 Mbps, CAT5, material: Plastic, connection method: Insulation displacement connection, cable outlet: straight, color: traffic grey A RAL 7042, PROFINET

PSM-ME-RS232/RS232-P - Interface converter

2744461

<https://www.phoenixcontact.com/us/products/2744461>



Interface converter, for the isolation of RS-232 (V.24) interfaces, 4 channels, rail-mountable

GW PN/ASCII 1E/2DB9 - Interface converters



1021058

<https://www.phoenixcontact.com/us/products/1021058>

PSM-ME-RS485/RS485-P - Repeater

2744429

<https://www.phoenixcontact.com/us/products/2744429>



Repeater, for potential separation and range increase in RS-485 2-wire bus systems, 3-way isolation, rail-mountable

TTC-6P-3-HF-F-M-24DC-PT-I - Surge protection device

2906797

<https://www.phoenixcontact.com/us/products/2906797>



Surge protection, consisting of protective plug and base element, with integrated status indicator and knife disconnection for three signal wires with common reference potential. For HF applications and telecommunications interfaces without supply voltage. Indirect grounding via gas discharge tube, Ex e approval for zone 2.

GW PN/ASCII 1E/2DB9 - Interface converters



1021058

<https://www.phoenixcontact.com/us/products/1021058>

TTC-6P-3-HF-F-M-12DC-UT-I - Surge protection device

2906786

<https://www.phoenixcontact.com/us/products/2906786>



Surge protection, consisting of protective plug and base element, with integrated status indicator and knife disconnection for three signal wires with common reference potential. For HF applications and telecommunications interfaces without supply voltage. Indirect grounding via gas discharge tube, Ex e approval for zone 2.

Phoenix Contact 2023 © - all rights reserved

<https://www.phoenixcontact.com>

Phoenix Contact USA
586 Fulling Mill Road
Middletown, PA 17057, United States
(+717) 944-1300
info@phoenixcon.com