



LED Display Product Data Sheet LTP-3862JD

Spec No.: DS30-2001-478

Effective Date: 08/25/2009

Revision: C

LITE-ON DCC

RELEASE

BNS-OD-FC001/A4

LED DISPLAY**LTP-3862JD**
DATA SHEET

<u>ITEM</u>	<u>Description</u>	<u>By</u>	<u>DATE</u>
01	Add comments in drawing	YUNYANG	10/Aug /2009

SPEC. NO.: _____

DATE : 10/Aug/2009REV. NO. : 01PAGE NO.: 1 of 6

FEATURES

- * 0.3 inch (7.62 mm) DIGIT HEIGHT
- * CONTINUOUS UNIFORM SEGMENTS
- * LOW POWER REQUIREMENT
- * EXCELLENT CHARACTERS APPEARANCE
- * HIGH BRIGHTNESS & HIGH CONTRAST
- * WIDE VIEWING ANGLE
- * SOLID STATE RELIABILITY
- * CATEGORIZED FOR LUMINOUS INTENSITY
- * **LEAD-FREE PACKAGE**

DESCRIPTION

The LTP-3862JD is a 0.3 inch (7.62 mm) digit height dual digit 16-segment alphanumeric display. This device uses AlInGaP Hyper Red LED chips (AlInGaP epi on GaAs substrate). The display has black face and white segments.

DEVICE

PART NO.	DESCRIPTION
AlInGaP Hyper Red	Multiplex Common Anode
LTP-3862JD	Rt. Hand Decimal

PACKAGE DIMENSIONS

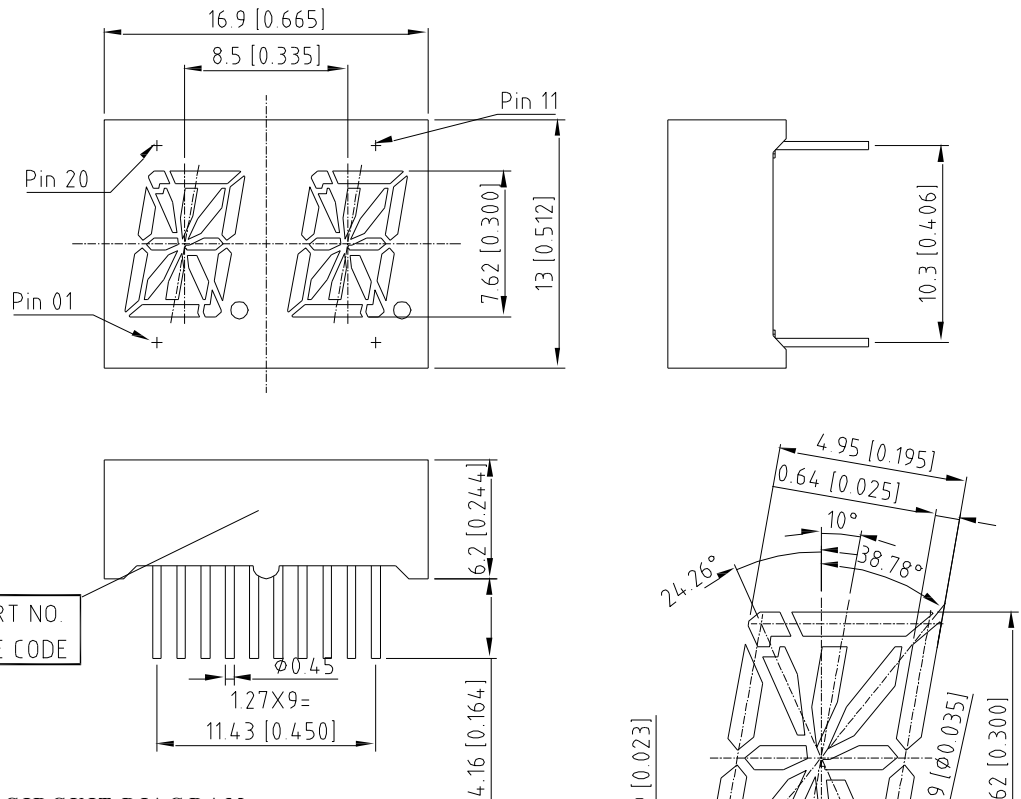

INTERNAL CIRCUIT DIAGRAM

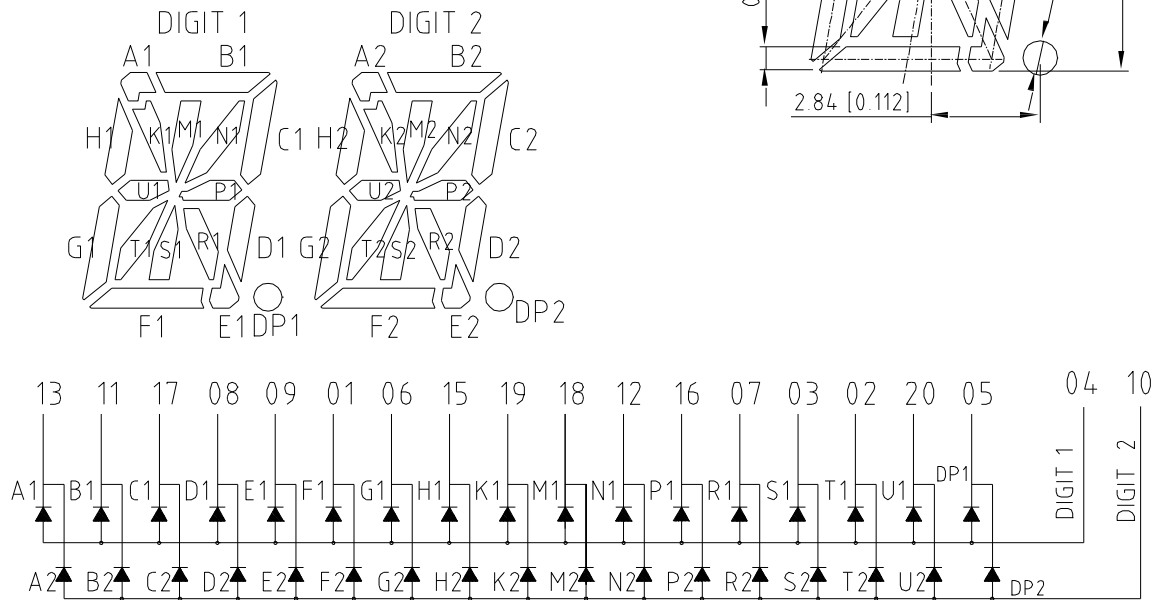

- NOTES:
 1. ALL DIMENSIONS ARE IN MILLIMETERS [INCHES].
 TOLERANCE: $\pm 0.25\text{mm} [\pm 0.01"]$ UNLESS OTHERWISE NOTED.
 2. THIS DEVICE HAS BLACK FACE AND WHITE SEGMENTS.
 3. THIS DEVICE HAS A PATTERN FILM IS ADDED ON IT.

PIN CONNECTION

No.	CONNECTION
1	CATHODE F
2	CATHODE T
3	CATHODE S
4	COMMON ANODE (Digit 1)
5	CATHODE DP
6	CATHODE G
7	CATHODE R
8	CATHODE D
9	CATHODE E
10	COMMON ANODE (Digit 2)
11	CATHODE B
12	CATHODE N
13	CATHODE A
14	NO CONNECTION
15	CATHODE H
16	CATHODE P
17	CATHODE C
18	CATHODE M
19	CATHODE K
20	CATHODE U

ABSOLUTE MAXIMUM RATING

PARAMETER	MAXIMUM RATING	UNIT
Power Dissipation Per Segment	70	mW
Peak Forward Current Per Segment (Frequency 1Khz, 10% duty cycle)	90	mA
Continuous Forward Current Per Segment	25	mA
Forward Current Derating from 25 ⁰ C	0.33	mA/ ⁰ C
Reverse Voltage Per Segment	5	V
Operating Temperature Range	-35 ⁰ C to +85 ⁰ C	
Storage Temperature Range	-35 ⁰ C to +85 ⁰ C	
Soldering Conditions : 1/16 inch below seating plane for 3 seconds at 260 ⁰ C		

ELECTRICAL / OPTICAL CHARACTERISTICS AT T_A=25⁰C

PARAMETER	SYMBOL	MIN.	TYP.	MAX.	UNIT	TEST CONDITION
Average Luminous Intensity Per Segment	I _v	320	900		μcd	I _F =1mA
Peak Emission Wavelength	λ _p		650		nm	I _F =20mA
Spectral Line Half-Width	Δλ		20		nm	I _F =20mA
Dominant Wavelength	λ _d		639		nm	I _F =20mA
Forward Voltage Per Segment	V _F		2.1	2.6	V	I _F =20mA
Reverse Current Per Segment	I _R			100	μA	V _R =5V
Luminous Intensity Matching Ratio	I _v -m			2:1		I _F =1mA

Note: Luminous intensity is measured with a light sensor and filter combination that approximates the CIE (Commision Internationale De L'Eclairage) eye-response curve.

TYPICAL ELECTRICAL / OPTICAL CHARACTERISTIC CURVES

(25°C Ambient Temperature Unless Otherwise Noted)

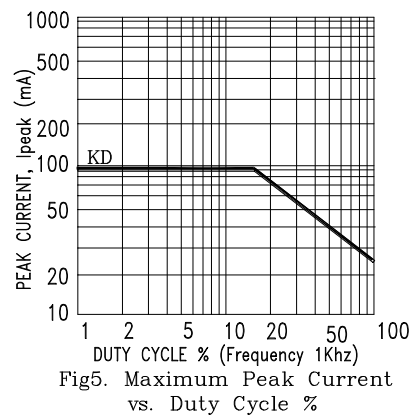
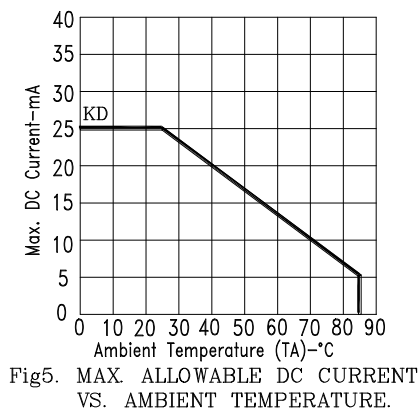
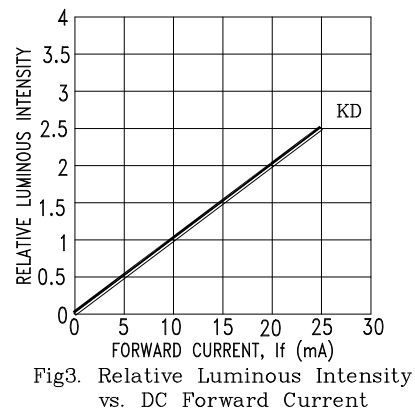
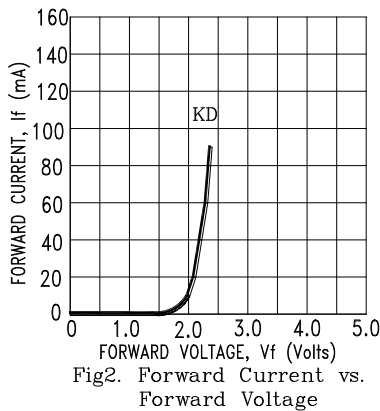
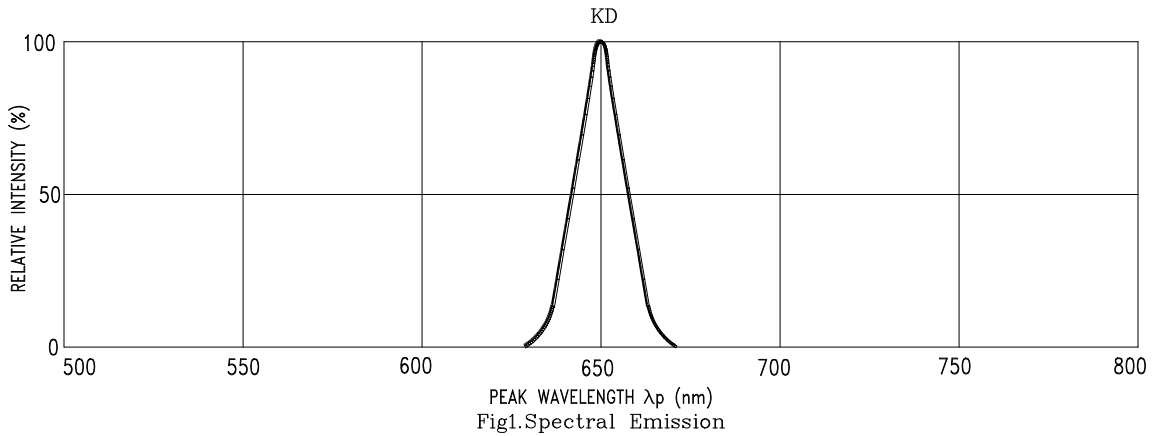

NOTE : KD=AlInGaP HYPER RED