

5338108-9 ✓ ACTIVE

Z-PACK | Z-PACK 2mm HM

TE Internal #: 5338108-9

PCB Ferrules & Shields, Shield (Lower), Ground Return Shielding, Z-PACK 2mm HM

[View on TE.com >](#)



Connectors > PCB Connectors > PCB Connector Accessories > PCB Protection & Strain Relief > PCB Ferrules & Shields

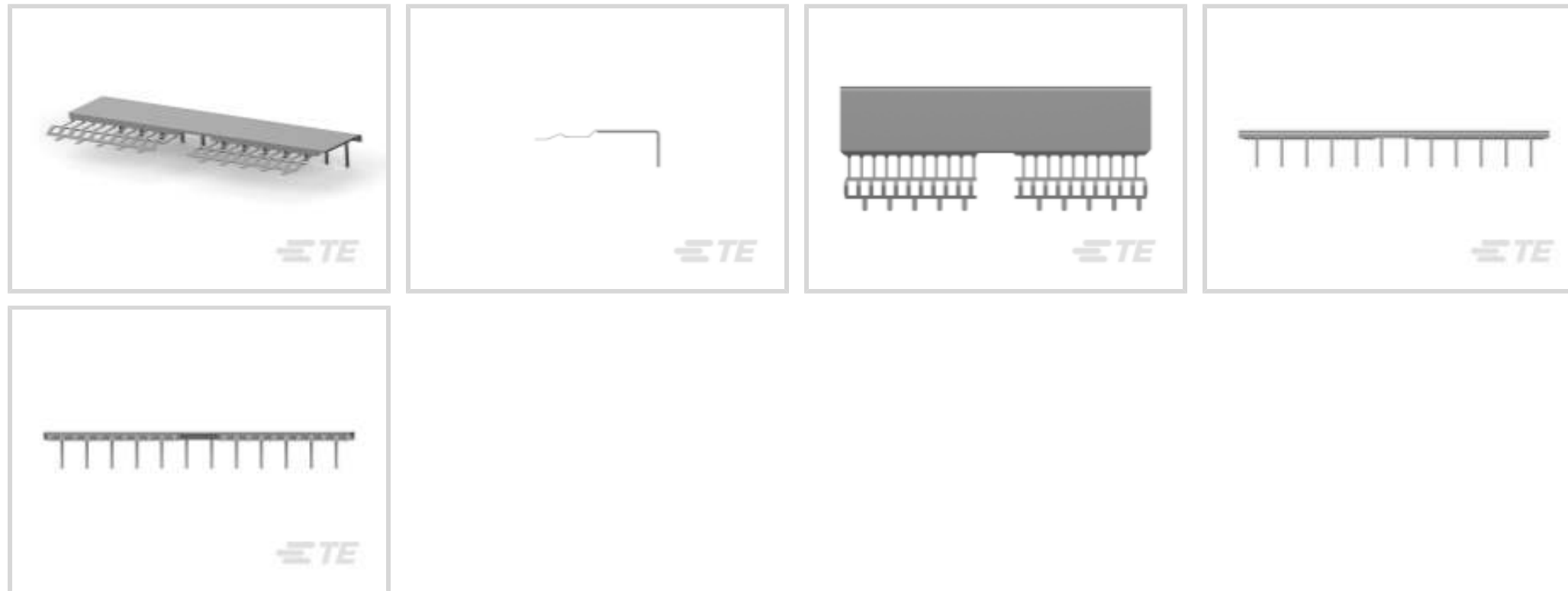

Connector Shielding Accessory Type: **Shield (Lower)**

Ground Feature Type: **Ground Return Shielding**

Features

Product Type Features

Connector Shielding Accessory Type	Shield (Lower)
Ground Feature Type	Ground Return Shielding

Contact Features

Contact Mating Area Plating Material	Tin
Contact Base Material	Phosphor Bronze

Packaging Features

Packaging Quantity	100
--------------------	-----

Other

Connector Accessory Comment	For use with Right Angle Female Connectors, 5 Row, Type A., Shields are supplied and fitted separately as required., Shields lubricated with Bellcore approved lubricant.
-----------------------------	---

Product Compliance

[For compliance documentation, visit the product page on TE.com>](#)

EU RoHS Directive 2011/65/EU	Compliant
EU ELV Directive 2000/53/EC	Compliant

China RoHS 2 Directive MIIT Order No 32, 2016	No Restricted Materials Above Threshold
EU REACH Regulation (EC) No. 1907/2006	Current ECHA Candidate List: JUNE 2023 (235) Candidate List Declared Against: JAN 2023 (233) Does not contain REACH SVHC
Halogen Content	Low Halogen - Br, Cl, F, I < 900 ppm per homogenous material. Also BFR/CFR/PVC Free
Solder Process Capability	Not applicable for solder process capability

Product Compliance Disclaimer

This information is provided based on reasonable inquiry of our suppliers and represents our current actual knowledge based on the information they provided. This information is subject to change. The part numbers that TE has identified as EU RoHS compliant have a maximum concentration of 0.1% by weight in homogenous materials for lead, hexavalent chromium, mercury, PBB, PBDE, DBP, BBP, DEHP, DIBP, and 0.01% for cadmium, or qualify for an exemption to these limits as defined in the Annexes of Directive 2011/65/EU (RoHS2). Finished electrical and electronic equipment products will be CE marked as required by Directive 2011/65/EU. Components may not be CE marked. Additionally, the part numbers that TE has identified as EU ELV compliant have a maximum concentration of 0.1% by weight in homogenous materials for lead, hexavalent chromium, and mercury, and 0.01% for cadmium, or qualify for an exemption to these limits as defined in the Annexes of Directive 2000/53/EC (ELV). Regarding the REACH Regulation, the information TE provides on SVHC in articles for this part number is based on the latest European Chemicals Agency (ECHA) 'Guidance on requirements for substances in articles' posted at this URL: <https://echa.europa.eu/guidance-documents/guidance-on-reach>

Compatible Parts

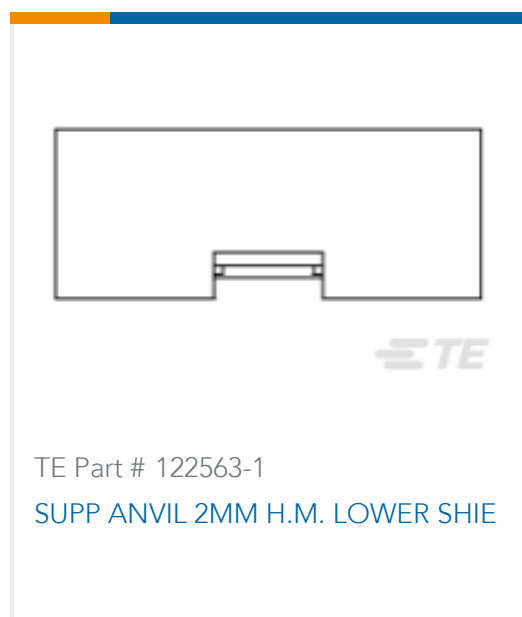

Also in the Series | Z-PACK 2mm HM

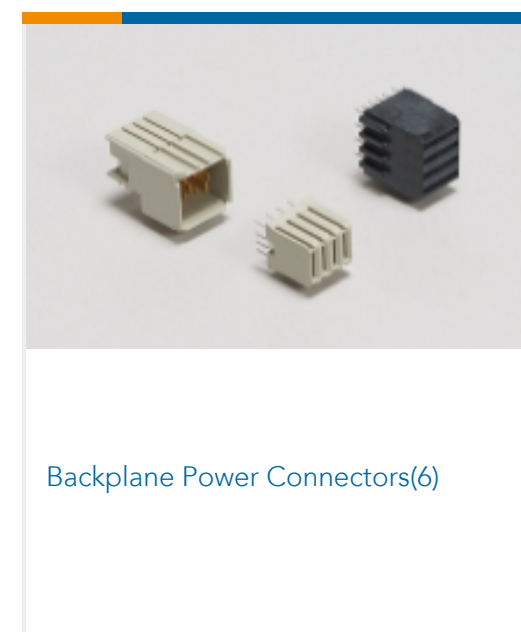
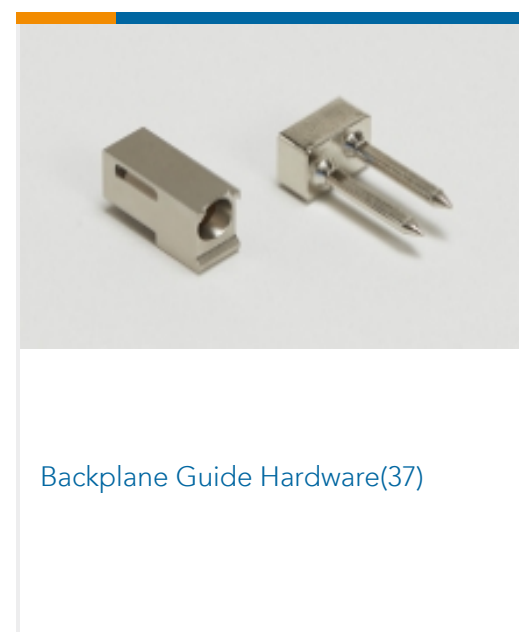
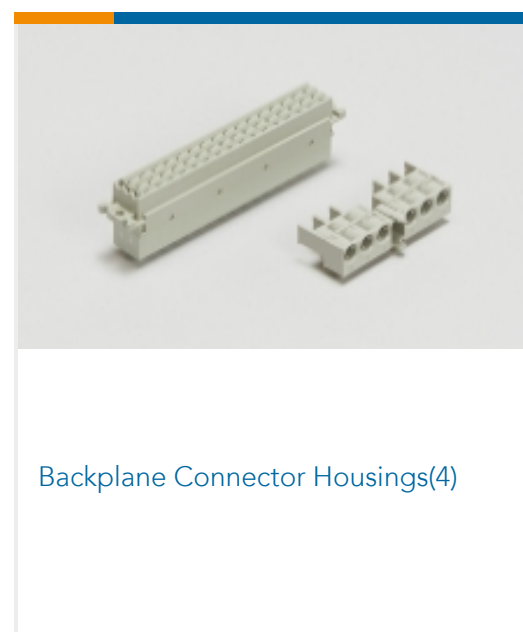
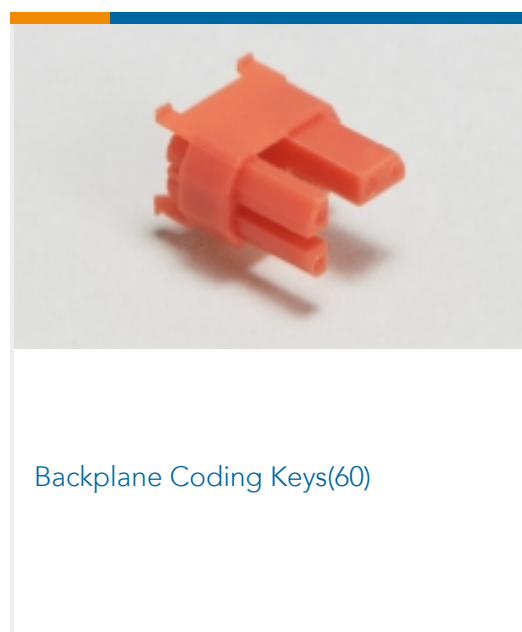



Board-to-Board Connector Contacts(2)

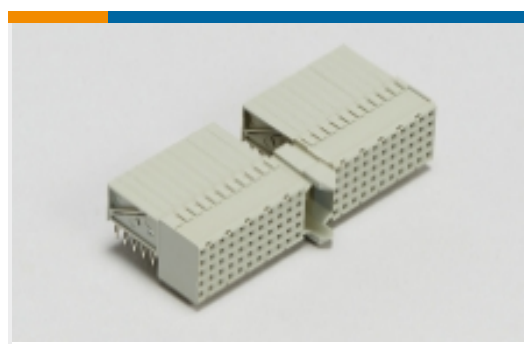

Hard Metric Backplane Connectors (269)

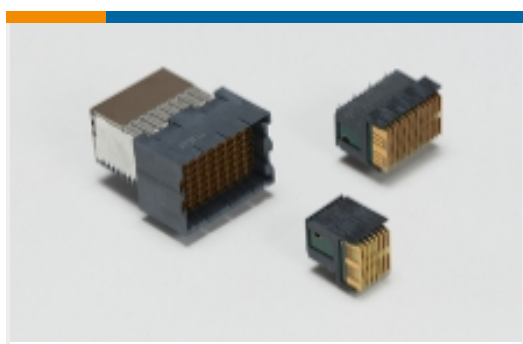

High Speed Backplane Connectors(1)



Insertion & Extraction Tools(2)

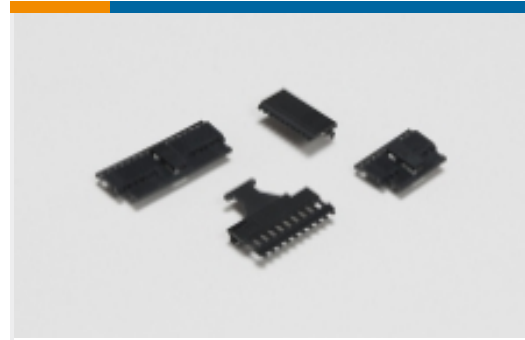

PCB Connector Covers(4)



PCB Connector Shrouds(39)



PCB Ferrules & Shields(19)



Rectangular Power Connectors(87)

Customers Also Bought



TE Part #1888247-1
20 POS SMT CONN, SFP/SFP+, 30A



TE Part #641239-3
03P MTA100 CONN ASSY BLU 30AU



TE Part #328527
TERMINAL,PG R 16-14 8



TE Part #5223957-1
UPM GUIDE MODULE



TE Part #2007263-1
SFP+ 1x2 Cage Assembly

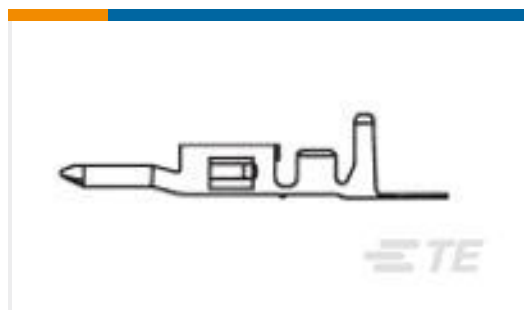

TE Part #1586314-3
VAL-U-LOK PIN PHBZ SN 24-18 LP



TE Part #1SNK505010R0000
ZS4



TE Part #1367147-1
SFP COVER, UNPLATED



TE Part #2007498-2
1X6 SFP PCI Cage Assembly



TE Part #2170394-4
QSFP HEAT SINK,13.5MM TALL,
NICKEL PLATIN

Documents



Product Drawings

Z-PACK SHLD.LOWER A

English

CAD Files

Customer View Model

[ENG_CVM_CVM_5338108-9_B.2d_dxf.zip](#)

English

3D PDF

3D

Customer View Model

[ENG_CVM_CVM_5338108-9_B.3d_igs.zip](#)

English

Customer View Model

[ENG_CVM_CVM_5338108-9_B.3d_stp.zip](#)

English

By downloading the CAD file I accept and agree to the [Terms and Conditions](#) of use.

Product Specifications

Product Specification

English