

### RONDA-WW

~60° wide beam with holder A compatible with 3rd party connectors from TE, Bender+Wirth and IDEAL

#### SPECIFICATION:

Dimensions	Ø 69.9 mm
Height	14.6 mm
Fastening	socket
ROHS compliant	yes ⓘ



#### MATERIALS:

Component	Type	Material	Colour	Finish
F15282_RONDA-WW	Single lens	PMMA	clear	
F15155_RONDA-HLD-A	Holder	PC	white	

#### ORDERING INFORMATION:

##### Quantities for one set:

Single lens	1
Holder	1



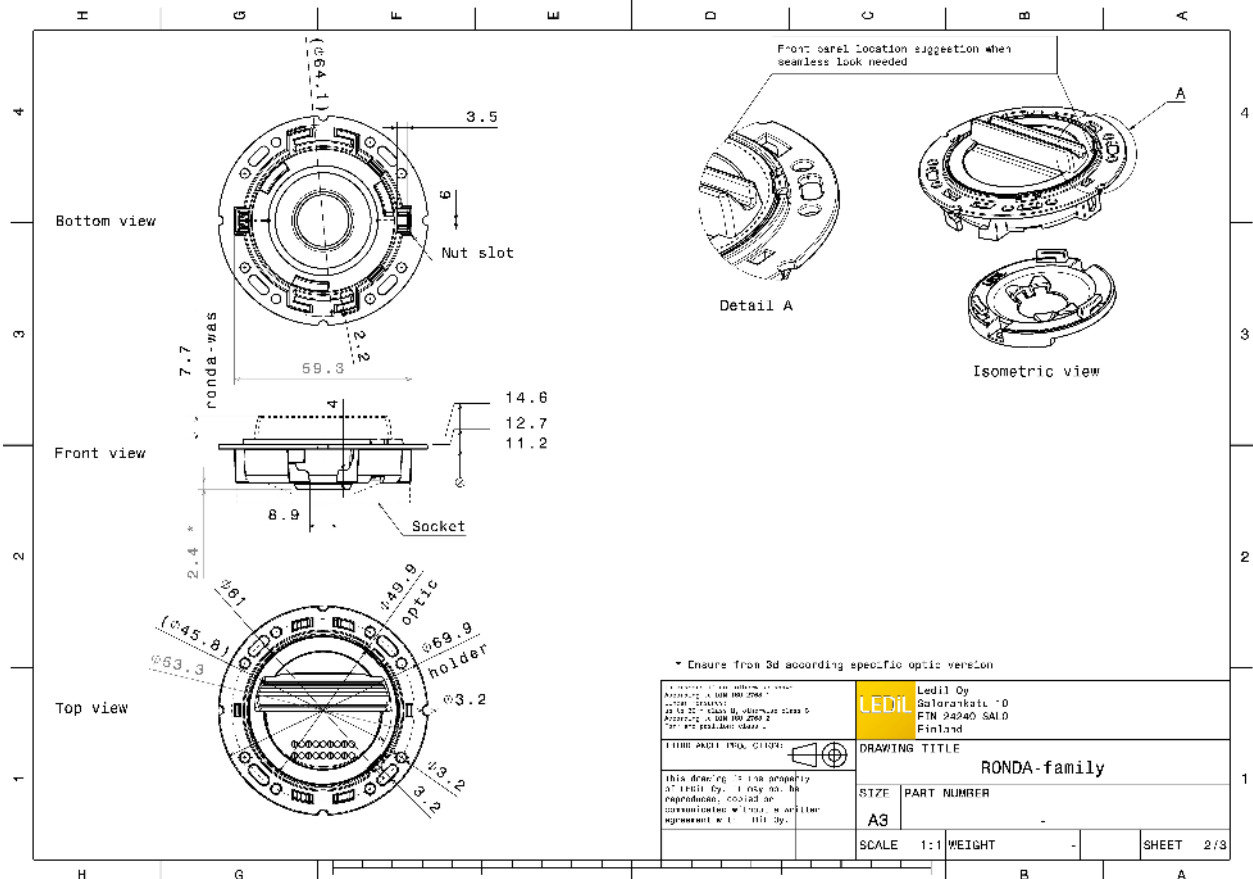
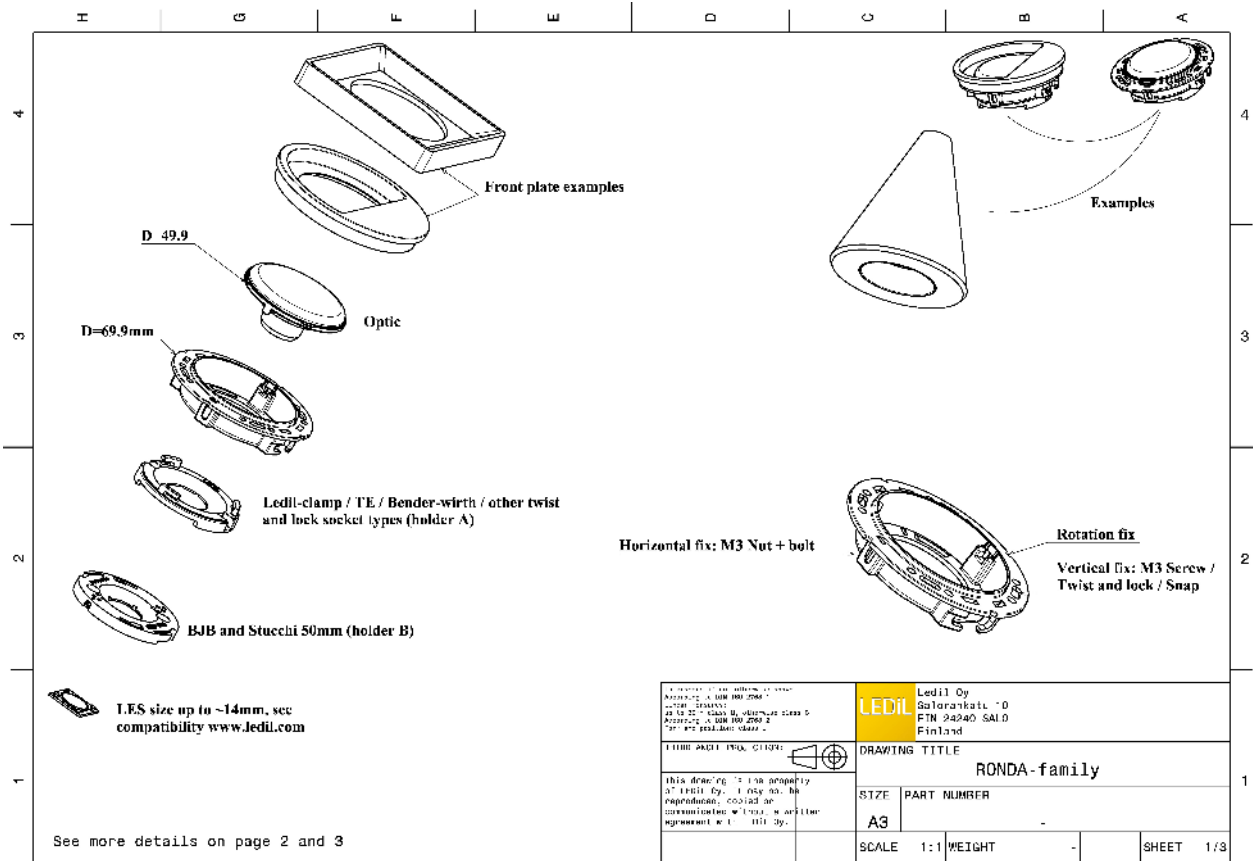

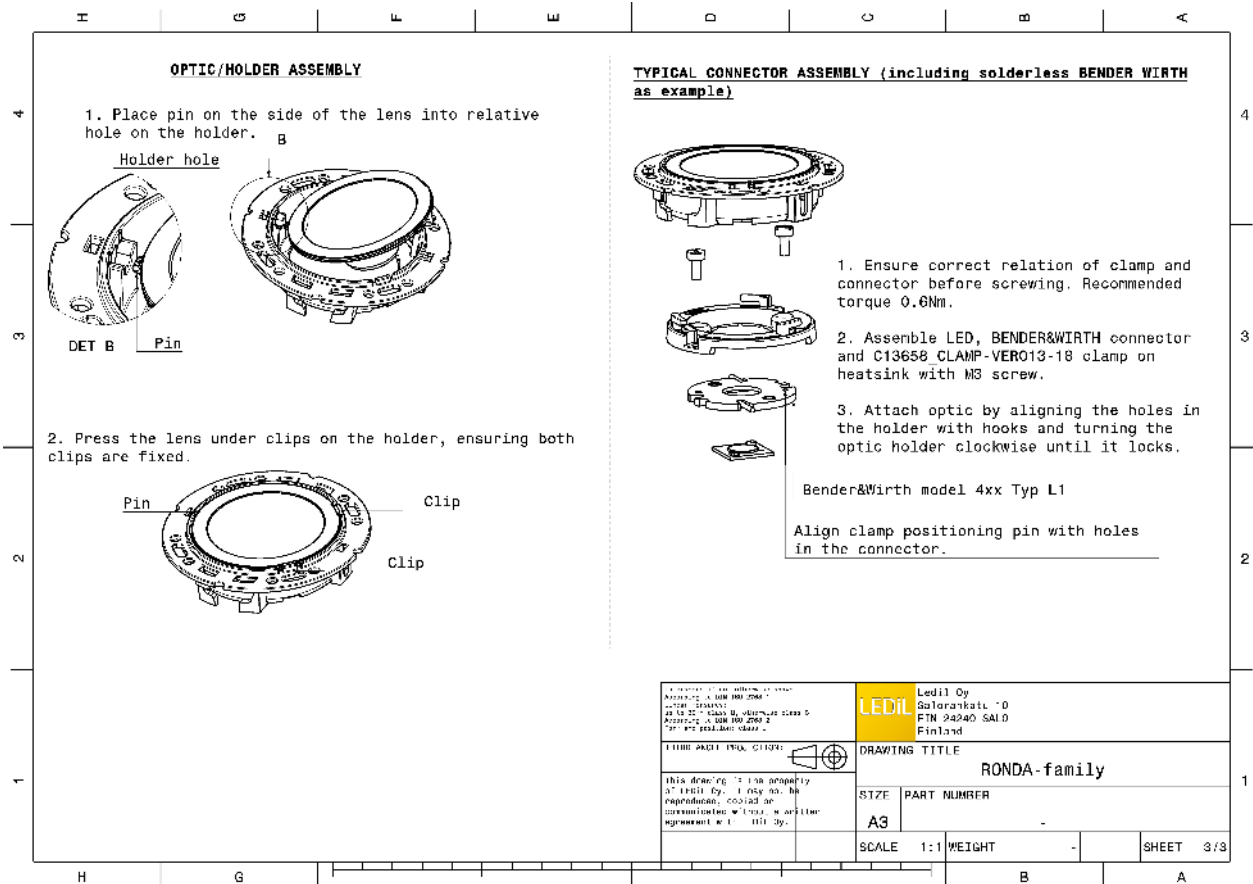

Component		Qty in box	MOQ	MPQ	Box weight (kg)
F15282_RONDA-WW	Single lens	420	120	30	7.2
» Box size: 480 x 280 x 300 mm					
F15155_RONDA-HLD-A	Holder	420	120	30	4.4
» Box size: 480 x 280 x 300 mm					



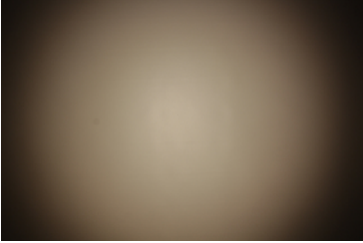
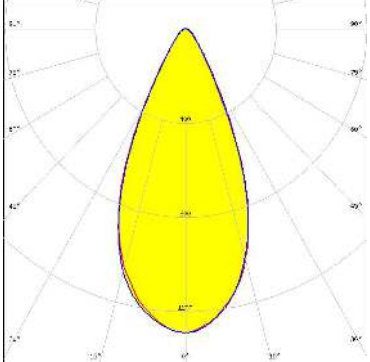

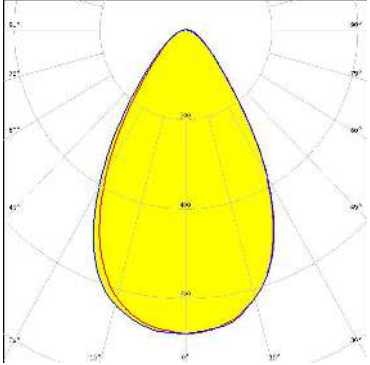
See also our general installation guide: [www.ledil.com/installation\\_guide](http://www.ledil.com/installation_guide)

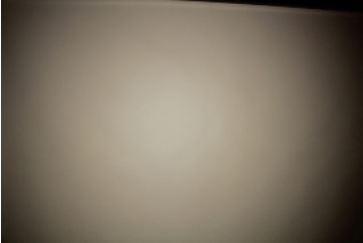
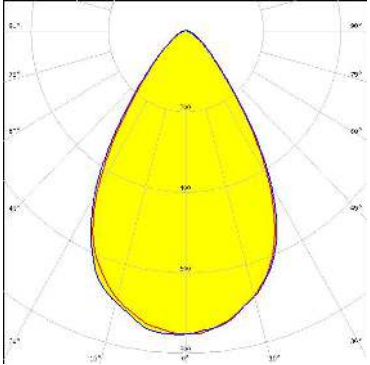
### OPTICAL RESULTS (MEASURED):

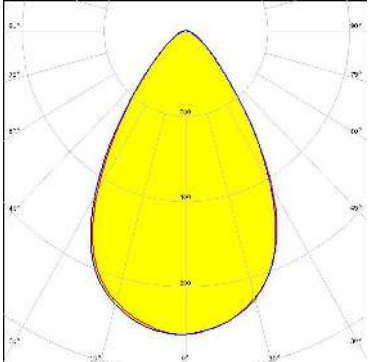
<p></p> <p>LED V10 Gen7            FWHM / FWTM 47.0° / 74.0°            Efficiency %            LEDs/each optic 1            Light colour White            Required components:            C13658_CLAMP-VERO13-18            Bender Wirth: 486 Typ L1</p>		
<p></p> <p>LED V13 Gen7            FWHM / FWTM 64.0° / 105.0°            Efficiency 82 %            Peak intensity 0.7 cd/lm            LEDs/each optic 1            Light colour White            Required components:            TE Connectivity: 2213254-2 + OPTIC CLIP Z50 TYPE1 2213194-1</p>		
<p></p> <p>LED Vero SE 13            FWHM / FWTM 65.0° / 100.0°            Efficiency 90 %            Peak intensity 0.8 cd/lm            LEDs/each optic 1            Light colour White            Required components:            C16402_CLAMP-VEROSE-13-18</p>		
<p></p> <p>LED VERO13            FWHM / FWTM 66.0° / 103.0°            Efficiency 88 %            Peak intensity 0.7 cd/lm            LEDs/each optic 1            Light colour White            Required components:            C13658_CLAMP-VERO13-18</p>		

### OPTICAL RESULTS (MEASURED):

#### CITIZEN

LED CLL03x/CLU03x  
 FWHM / FWTM 59.0° / 110.0°  
 Efficiency 81 %  
 Peak intensity 0.7 cd/lm  
 LEDs/each optic 1  
 Light colour White  
 Required components:  
 IDEAL: 50-2103CT + 50-2100AN

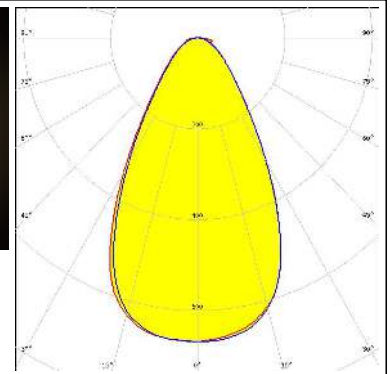
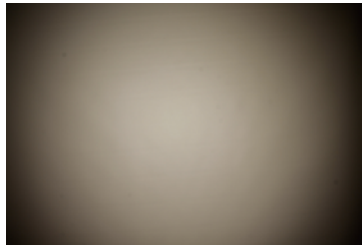

#### CITIZEN

LED CLL03x/CLU03x  
 FWHM / FWTM 63.0° / 105.0°  
 Efficiency 87 %  
 Peak intensity 0.7 cd/lm  
 LEDs/each optic 1  
 Light colour White  
 Required components:  
 C16791\_CLAMP-Z45-A  
 TE Connectivity: 2325807-3

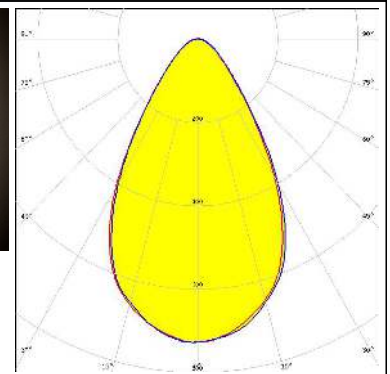
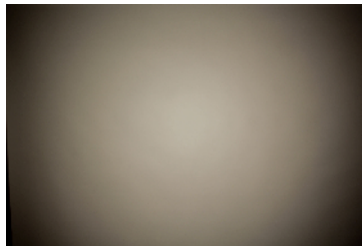

#### CITIZEN

LED CLL04x/CLU04x  
 FWHM / FWTM 66.0° / 130.0°  
 Efficiency 81 %  
 Peak intensity 0.5 cd/lm  
 LEDs/each optic 1  
 Light colour White  
 Required components:  
 IDEAL: 50-2204-CT + 50-2100AN

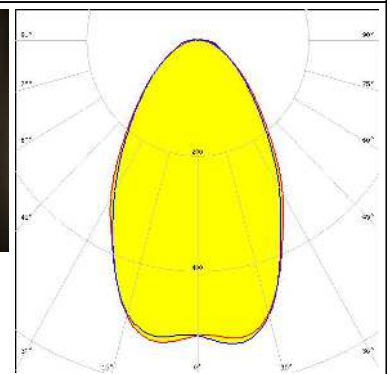
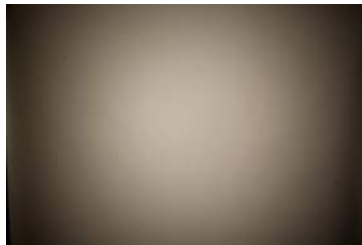

#### CITIZEN

LED CLU730/731/733  
 FWHM / FWTM 58.0° / 103.0°  
 Efficiency 83 %  
 Peak intensity 0.7 cd/lm  
 LEDs/each optic 1  
 Light colour White  
 Required components:  
 IDEAL: 50-2204-CT + 50-2100AN

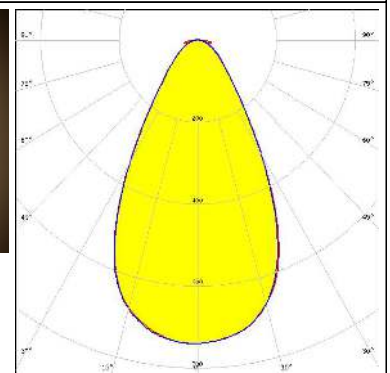

### OPTICAL RESULTS (MEASURED):

#### CREE LED

LED CMA1840  
 FWHM / FWTM 69.0° / 112.0°  
 Efficiency 89 %  
 Peak intensity 0.7 cd/m  
 LEDs/each optic 1  
 Light colour White  
 Required components:  
 C14123\_CLAMP-CXA15-18

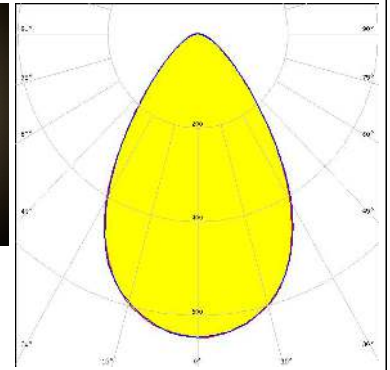

#### CREE LED

LED CXA/B 1816 & CXA/B 1820 & CXA 1850  
 FWHM / FWTM 66.0° / 100.0°  
 Efficiency 93 %  
 Peak intensity 0.8 cd/m  
 LEDs/each optic 1  
 Light colour White  
 Required components:  
 C14123\_CLAMP-CXA15-18

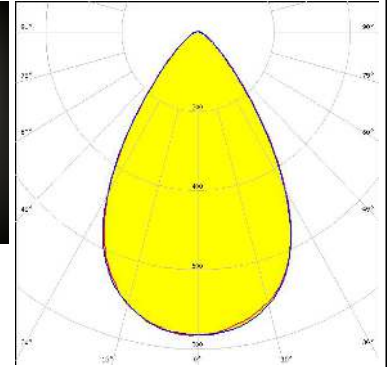

#### CREE LED

LED CXA/B 1816 & CXA/B 1820 & CXA 1850  
 FWHM / FWTM 62.0° / 97.0°  
 Efficiency 88 %  
 Peak intensity 0.8 cd/m  
 LEDs/each optic 1  
 Light colour White  
 Required components:  
 TE Connectivity: 2213401-2 + OPTIC CLIP Z50 TYPE1 2213194-1

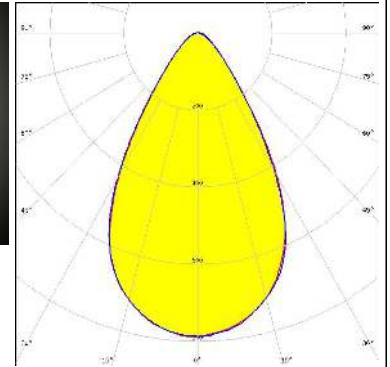



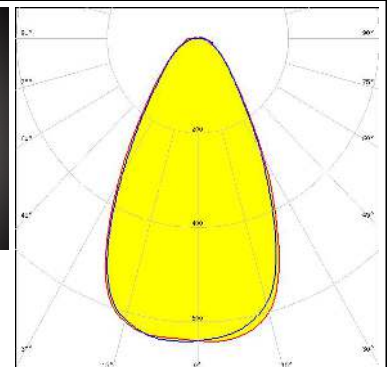
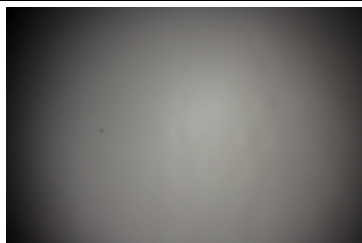

#### NICHIA

LED COB J-Type  
 FWHM / FWTM 60.0° / 113.0°  
 Efficiency 81 %  
 Peak intensity 0.6 cd/m  
 LEDs/each optic 1  
 Light colour White  
 Required components:  
 IDEAL: 50-2103NC + 50-2100AN

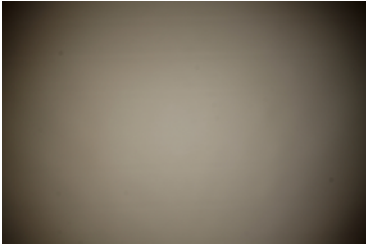
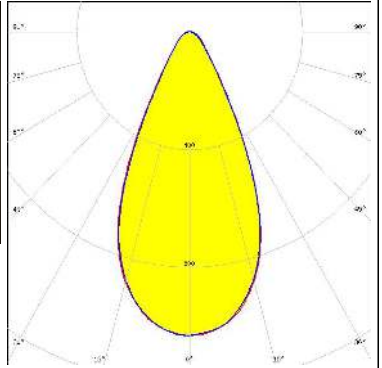
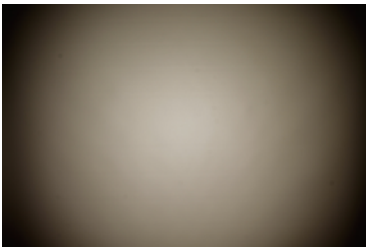
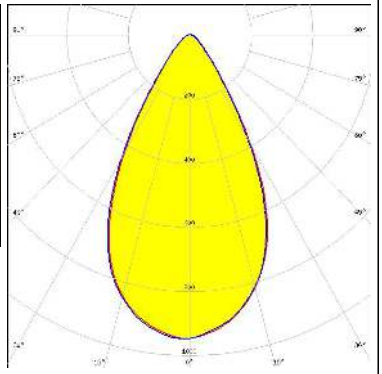

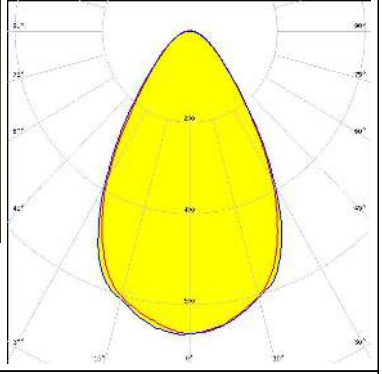
### OPTICAL RESULTS (MEASURED):

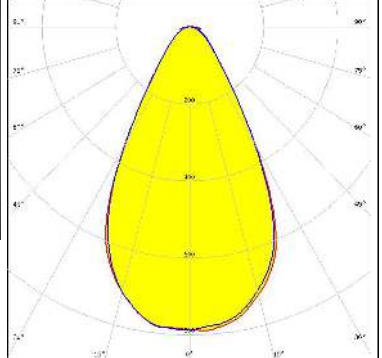
<p><b>NICHIA</b></p> <p>LED COB L-Type (LES 11)</p> <p>FWHM / FWTM 50.0° / 81.0°</p> <p>Efficiency 85 %</p> <p>Peak intensity 1 cd/lm</p> <p>LEDs/each optic 1</p> <p>Light colour White</p> <p>Required components: IDEAL: 50-2100NC + 50-2100AN</p>		
<p><b>NICHIA</b></p> <p>LED COB L-Type (LES 11)</p> <p>FWHM / FWTM 57.0° / 87.0°</p> <p>Efficiency 88 %</p> <p>Peak intensity 1 cd/lm</p> <p>LEDs/each optic 1</p> <p>Light colour White</p> <p>Required components: TE Connectivity: 2213382-2 + OPTIC CLIP Z50 TYPE1 2213194-1</p>		
<p><b>OSRAM</b></p> <p>LED PrevaLED Core G7 L15 H1</p> <p>FWHM / FWTM 65.0° / 111.0°</p> <p>Efficiency 86 %</p> <p>Peak intensity 0.7 cd/lm</p> <p>LEDs/each optic 1</p> <p>Light colour White</p> <p>Required components: C16685_CLAMP-PRV-A</p>		
<p><b>OSRAM</b> Opto Semiconductors</p> <p>LED Soleriq S13 19x19</p> <p>FWHM / FWTM 58.0° / 97.0°</p> <p>Efficiency 85 %</p> <p>Peak intensity 0.8 cd/lm</p> <p>LEDs/each optic 1</p> <p>Light colour White</p> <p>Required components: IDEAL: 50-2103CT + 50-2100AN</p>		



### OPTICAL RESULTS (MEASURED):

#### OSRAM

Opto Semiconductors

LED Soleriq S13 19x19  
FWHM / FWTM 63.0° / 99.0°  
Efficiency 84 %  
Peak intensity 0.7 cd/lm  
LEDs/each optic 1  
Light colour White

Required components:

TE Connectivity: 2213254-2 + OPTIC CLIP Z50 TYPE1 2213194-1

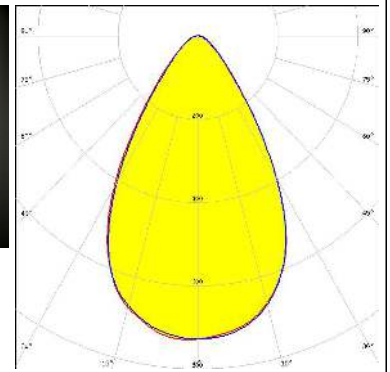
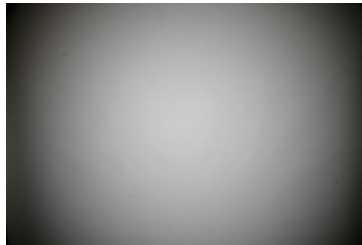

#### PHILIPS

LED Fortimo SLM L13 + SLM holder  
FWHM / FWTM 61.0° / 101.0°  
Efficiency 82 %  
Peak intensity 0.7 cd/lm  
LEDs/each optic 1  
Light colour White

Required components:

TE Connectivity: OPTIC CLIP Z50 TYPE1 2213194-1

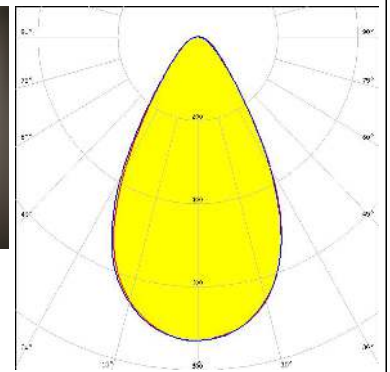
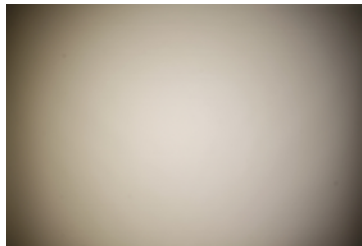

#### PHILIPS

LED Fortimo SLM L13 CoB  
FWHM / FWTM 66.0 + ° / 103.0°  
Efficiency 85 %  
Peak intensity 0.7 cd/lm  
LEDs/each optic 1  
Light colour White

Required components:

TE Connectivity: 2213130-2 + OPTIC CLIP Z50 TYPE1 2213194-1

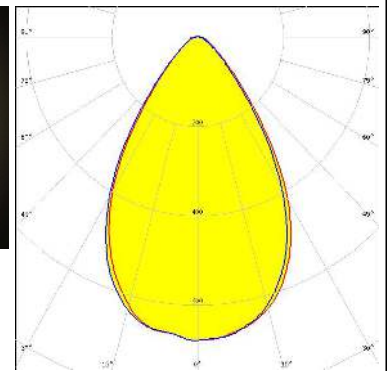

#### PHILIPS

LED Fortimo SLM L15 + SLM holder  
FWHM / FWTM 66.0° / 114.0°  
Efficiency 83 %  
Peak intensity 0.6 cd/lm  
LEDs/each optic 1  
Light colour White

Required components:

TE Connectivity: OPTIC CLIP Z50 TYPE1 2213194-1

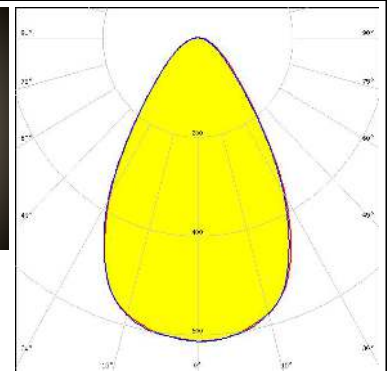
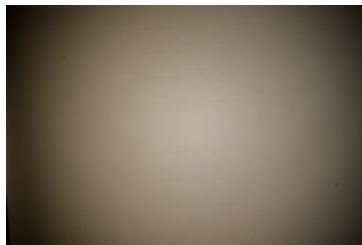

### OPTICAL RESULTS (MEASURED):

#### SAMSUNG

LED LC040C  
 FWHM / FWTM 60.0° / 93.0°  
 Efficiency 86 %  
 Peak intensity 0.8 cd/m  
 LEDs/each optic 1  
 Light colour White  
 Required components:  
 TE Connectivity: 2213382-2 + OPTIC CLIP Z50 TYPE1 2213194-1

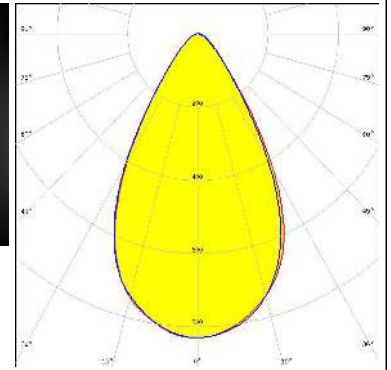
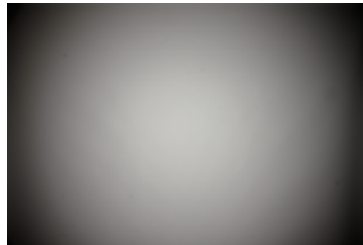

**SECOIL SEMICONDUCTOR**  
 LED AC Zhaga COB  
 FWHM / FWTM 67.0° / 113.0°  
 Efficiency 84 %  
 Peak intensity 0.6 cd/m  
 LEDs/each optic 1  
 Light colour White  
 Required components:  
 Optosource: SEHSMJD-A

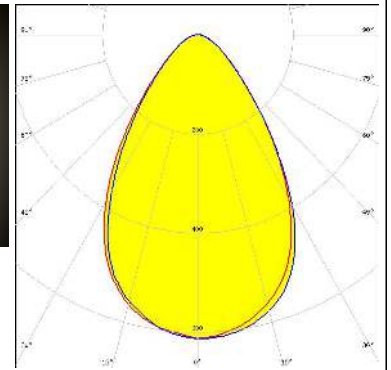
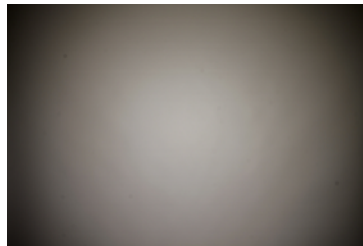

**SECOIL SEMICONDUCTOR**  
 LED MJT COB LES 14.5  
 FWHM / FWTM 69.0° / 113.0°  
 Efficiency 80 %  
 Peak intensity 0.6 cd/m  
 LEDs/each optic 1  
 Light colour White  
 Required components:  
 TE Connectivity: 2213254-2 + OPTIC CLIP Z50 TYPE1 2213194-1

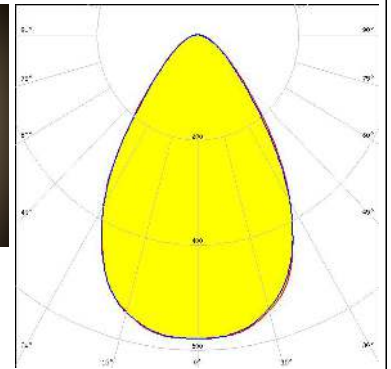
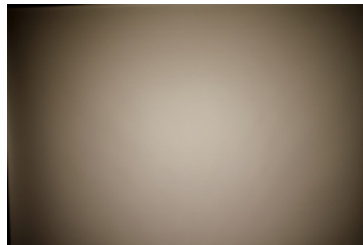

**VS LIGHTING SOLUTIONS**  
 LED WU-M-484  
 FWHM / FWTM 69.0° / 112.0°  
 Efficiency 83 %  
 Peak intensity 0.6 cd/m  
 LEDs/each optic 1  
 Light colour White  
 Required components:  
 TE Connectivity: OPTIC CLIP Z50 TYPE1 2213194-1

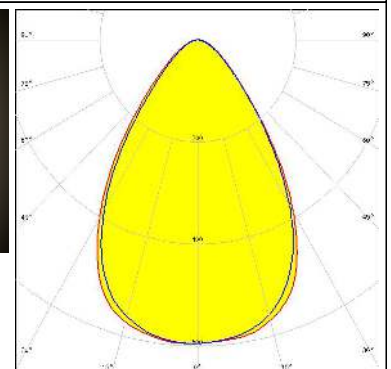
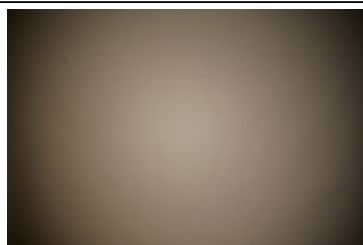

### OPTICAL RESULTS (SIMULATED):

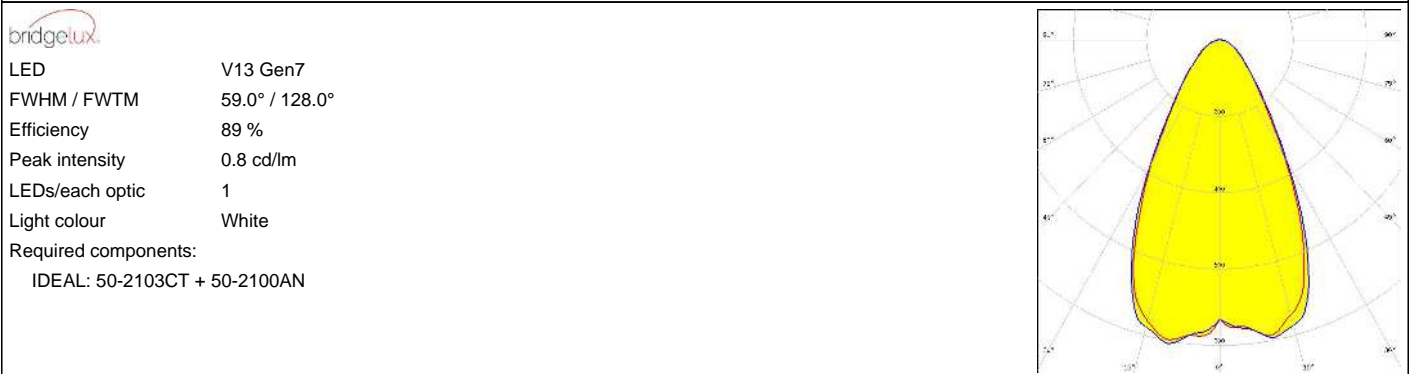

### CITIZEN



### OPTICAL RESULTS (SIMULATED):

#### CITIZEN

LED CLU700/701/702/703  
 FWHM / FWTM 60.0°  
 Efficiency 89 %  
 LEDs/each optic 1  
 Light colour White  
 Required components:  
 C13658\_CLAMP-VERO13-18  
 Bender Wirth: 434 Typ L1

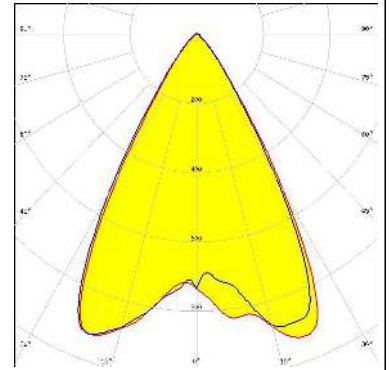

#### CITIZEN

LED CLU710/711  
 FWHM / FWTM 60.0°  
 Efficiency 88 %  
 LEDs/each optic 1  
 Light colour White  
 Required components:  
 C13658\_CLAMP-VERO13-18  
 Bender Wirth: 470 Typ L1



LED CXA/B 13xx  
 FWHM / FWTM 62.0°  
 Efficiency 89 %  
 LEDs/each optic 1  
 Light colour White  
 Required components:  
 C13658\_CLAMP-VERO13-18  
 Bender Wirth: 448 Typ L1

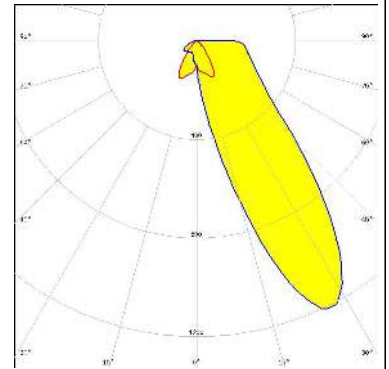

LED CXA/B 15xx  
 FWHM / FWTM 62.0°  
 Efficiency 89 %  
 LEDs/each optic 1  
 Light colour White  
 Required components:  
 C14123\_CLAMP-CXA15-18

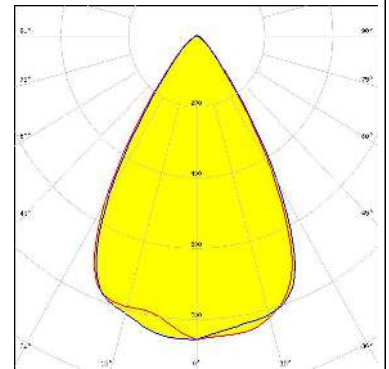

### OPTICAL RESULTS (SIMULATED):

<p><b>CREE</b> → <b>LED</b></p> <p>LED                      CXA/B 15xx  FWHM / FWTM        62.0°  Efficiency              89 %  LEDs/each optic     1  Light colour           White  Required components:  C13658_CLAMP-VERO13-18  Bender Wirth: 441 Typ L1</p>	
<p><b>CREE</b> → <b>LED</b></p> <p>LED                      CXA/B 1816 &amp; CXA/B 1820 &amp; CXA 1850  FWHM / FWTM        63.0°  Efficiency              89 %  LEDs/each optic     1  Light colour           White  Required components:  C13658_CLAMP-VERO13-18  Bender Wirth: 437 Typ L1</p>	
<p><b>CREE</b> → <b>LED</b></p> <p>LED                      CXA/B 1830  FWHM / FWTM        62.0°  Efficiency              87 %  LEDs/each optic     1  Light colour           White  Required components:  C14123_CLAMP-CXA15-18</p>	
<p><b>LUMILEDS</b></p> <p>LED                      LUXEON CoB 1202/1203  FWHM / FWTM        56.0° / 82.0 + 80.0°  Efficiency              87 %  Peak intensity        1 cd/Im  LEDs/each optic     1  Light colour           White  Required components:  TE Connectivity: 2213382-2 + OPTIC CLIP Z50 TYPE1 2213194-1</p>	

### OPTICAL RESULTS (SIMULATED):

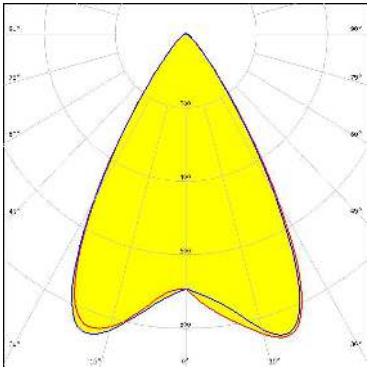
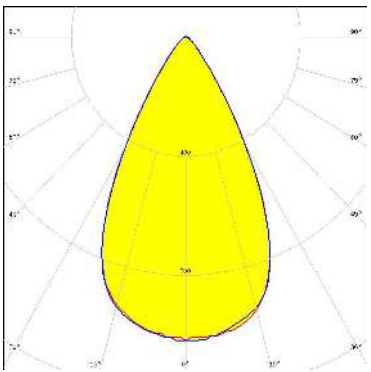
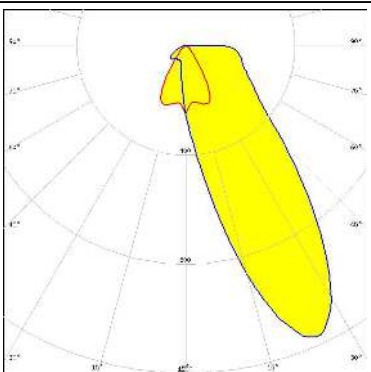
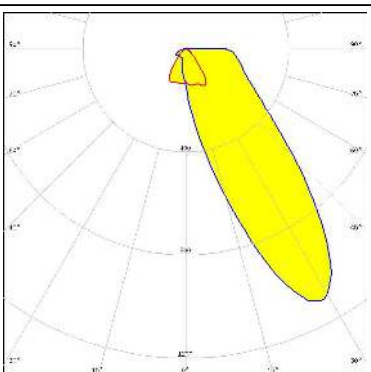
<p><b>LUMILEDS</b></p> <p>LED LUXEON CoB 1202s            FWHM / FWTM 60.0°            Efficiency 89 %            LEDs/each optic 1            Light colour White            Required components:            C13658_CLAMP-VERO13-18            Bender Wirth: 452 Typ L1</p>	
<p><b>NICHIA</b></p> <p>LED COB L-Type (LES 9)            FWHM / FWTM 56.0° / 80.0°            Efficiency 87 %            Peak intensity 1 cd/lm            LEDs/each optic 1            Light colour White            Required components:            TE Connectivity: 2213382-2 + OPTIC CLIP Z50 TYPE1 2213194-1</p>	
<p><b>NICHIA</b></p> <p>LED NSCxL036A            FWHM / FWTM 56.0° / 74.0 + 77.0°            Efficiency 88 %            Peak intensity 1 cd/lm            LEDs/each optic 1            Light colour White            Required components:            TE Connectivity: 2213382-2 + OPTIC CLIP Z50 TYPE1 2213194-1</p>	
<p><b>OSRAM</b>  <small>Opto Semiconductors</small></p> <p>LED Duris S10            FWHM / FWTM 66.0°            Efficiency 89 %            LEDs/each optic 1            Light colour White            Required components:            C13658_CLAMP-VERO13-18</p>	

### OPTICAL RESULTS (SIMULATED):

#### OSRAM

Opto Semiconductors

LED Soleriq S13  
FWHM / FWTM 63.0°  
Efficiency 84 %  
LEDs/each optic 1  
Light colour White  
Required components:  
C14123\_CLAMP-CXA15-18

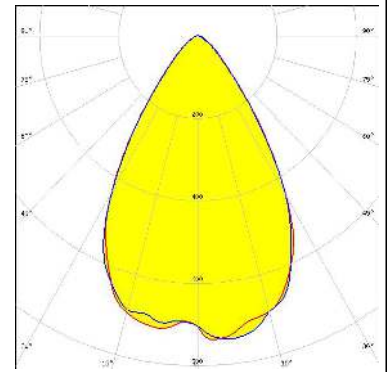

#### SHARP

LED Mini Zenigata (GW6BM)  
FWHM / FWTM 62.0°  
Efficiency 88 %  
LEDs/each optic 1  
Light colour White  
Required components:  
C13658\_CLAMP-VERO13-18  
Bender Wirth: 452 Typ L1

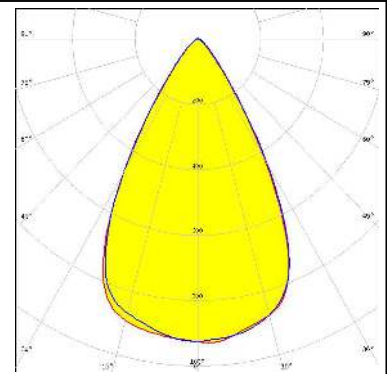

### GENERAL INFORMATION:

NOTE: The typical beam angle will be changed by different color, chip size and chip position tolerance. The typical total beam angle is the full angle measured where the luminous intensity is half of the peak value.

Due to use of high power COB's with this product, special attention to proper thermal design is highly recommended. LEDiL has no liability for direct, indirect or consecutive damages arising from the LEDiL products being used outside of the recommended temperature range.

### MATERIALS:

As part of our continuous research and improvement processes, and to ensure the best possible quality and availability of our products, LEDiL reserves the right to change material grades without notice.

### PRODUCT DATA USER AGREEMENT AND DISCLAIMER:

The measured data in the provided downloadable LEDiL Product Datasheets and Mechanical 2D-Drawings is rounded and provided as reference for planning. LEDiL Oy's optical specifications have been verified by conducting performance testing of the products in accordance with the company's quality system. The reported data are averaged results of multiple measurements with typical variation. LEDiL Oy reserves the right to without prior notification make changes and improvements to its products.

LEDiL Oy assumes neither warranty, nor guarantee nor any other liability of any kind for the contents and correctness of the provided data. The provided data has been generated with highest diligence but the provided data may in reality not represent the complete possible variation range of all intrinsic parameters. Therefore, in certain cases a deviation from the provided data could occur.

LEDiL Oy reserves the right to undertake technical changes of its products without further notification which could lead to changes in the provided data. LEDiL Oy assumes no liability of any kind for the possible deviation from any provided data or any other damage resulting from the usage of the provided data.

The user agrees to this disclaimer and user agreement with the download or usage of the provided files.

#### LEDiL Oy

Joensuunkatu 13  
FI-24240 SALO  
Finland

#### LEDiL Inc.

228 West Page Street  
Suite D  
Sycamore IL 60178  
USA

#### Ledil Optics Technology (Shenzhen) Co., Ltd.

# 405 , Block B  
Casic Motor Building  
Shenzhen 518057  
P.R.CHINA

#### Local sales and technical support

[www.ledil.com/  
where\\_to\\_buy](http://www.ledil.com/where_to_buy)

#### Shipping locations

Salo, Finland  
Hong Kong, China

#### Distribution Partners

[www.ledil.com/  
where\\_to\\_buy](http://www.ledil.com/where_to_buy)