

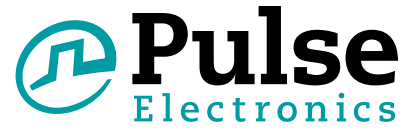





High Frequency Batcore Planar Transformer

ER25+ (up to 800W)



-  **Power Rating:** up to 800W
-  **Height:** 18.3mm Max
-  **Footprint:** 33.5mm x 26.8mm Max
-  **Frequency Range:** 200kHz to 700kHz
-  **Isolation (Primary to Secondary):** 1500VDC
-  Patent pending

Electrical Specifications @ 25°C - Operating Temperature -40°C to +125°C

Part Number	Turns Ratio			Primary Inductance (μ H MIN)	Leakage Inductance (μ H MAX)	DCR (m Ω MAX)		
	Primary	Secondary A	Secondary B			Primary	Secondary A	Secondary B
PH9278NL	3T	3T	3T	37.8	0.12	2.4	2.4	2.4

Mechanical

Schematic

PH9278NL

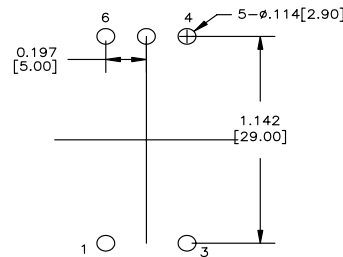
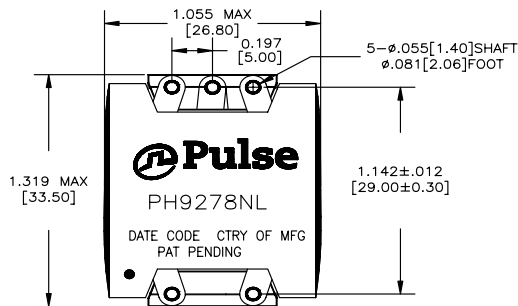

SUGGESTED LAND PATTERN

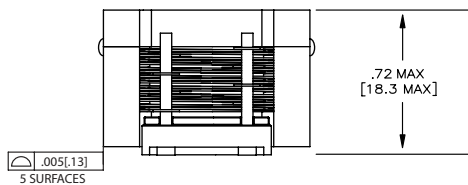
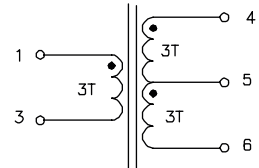

Weight 45 grams
 Tray 30/tray
 Tape & Reel 45/reel

Dimensions: $\frac{\text{Inches}}{\text{mm}}$
 Unless otherwise specified,
 all tolerances are \pm .010
 0.25

USA 858 674 8100

Germany 49 7032 7806 0

Singapore 65 6287 8998

Shanghai 86 21 62787060

China 86 755 33966678

Taiwan 886 3 4356768

High Frequency Batcore Planar Transformer

ER25+ (up to 800W)

Notes

PH9278NL

1. Leakage inductance is measured on winding (1-3) with (4,5,6)shorted.
2. The "NL" suffix indicates a ROHS-compliant part number.
3. Other primary and secondary turns are available on request.
4. Optional Tape & Reel packaging can be ordered by adding a "T" suffix to the complete number (e.g. PH9278NL becomes PH9278NLT).
5. To determine if the transformer is suitable for your application, it is necessary to ensure that the temperature rise of the component (ambient plus temperature rise) not exceed its operating temperature. To determine the approximate temperature rise of the transformer, refer to the graphs below.

Core Loss vs Flux Density

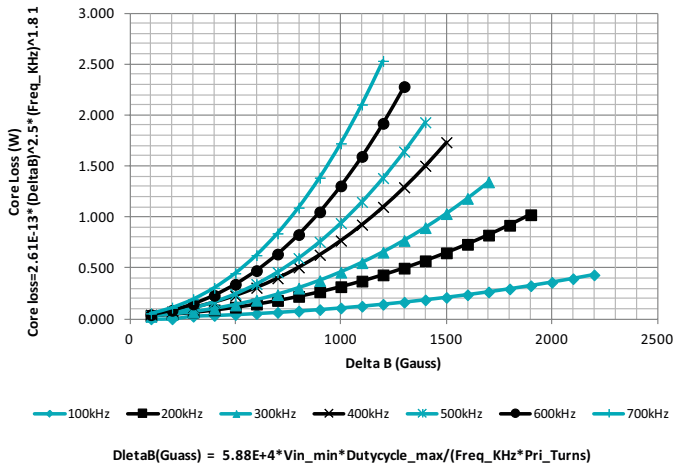

Temperature Rise vs. Power Dissipation

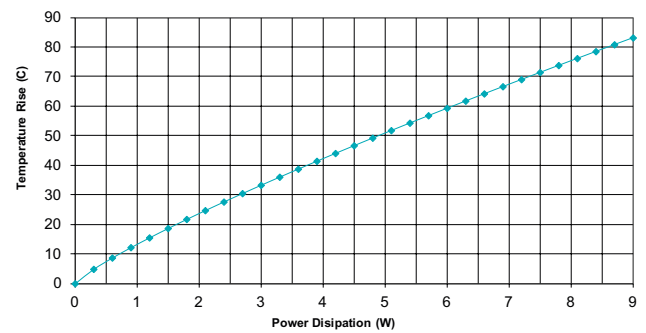

For More Information

Pulse Worldwide Headquarters
12220 World Trade Drive
San Diego, CA 92128
U.S.A.

Tel: 858 674 8100
Fax: 858 674 8262

Pulse Europe
Zeppelinstrasse 15
71083 Herrenberg
Germany

Tel: 49 7032 7806 0
Fax: 49 7032 7806 12

Pulse China Headquarters
B402, Shenzhen Academy of
Aerospace Technology Bldg.
10th Kejian Road
High-Tech Zone
Nanshan District
Shenzhen, PR China 518057
Tel: 86 755 33966678
Fax: 86 755 33966700

Pulse North China
Room 2704/2705
Super Ocean Finance Ctr.
2067 Yan An Road West
Shanghai 200336
China

Tel: 86 21 62787060
Fax: 86 2162786973

Pulse South Asia
135 Joo Seng Road
#03-02
PM Industrial Bldg.
Singapore 368363

Tel: 65 6287 8998
Fax: 65 6287 8998

Pulse North Asia
3F, No. 198
Zhongyuan Road
Zhongli City
Taoyuan County 320
Taiwan R. O. C.
Tel: 886 3 4356768
Fax: 886 3 4356823 (Pulse)
Fax: 886 3 4356820 (FRE)

Performance warranty of products offered on this data sheet is limited to the parameters specified. Data is subject to change without notice. Other brand and product names mentioned herein may be trademarks or registered trademarks of their respective owners. © Copyright, 2014. Pulse Electronics, Inc. All rights reserved.