

DESCRIPTION

The EV023-S-00A Evaluation Board is designed to demonstrate the capabilities of MP023. The MP023 is a primary-side-control controller which can eliminate secondary feedback components.

The EV023-S-00A is typically designed for cell phone which output 5V, 2.4A load from 85VAC to 265VAC, 50HZ/60HZ.

The EV023-S-00A has an excellent efficiency and EN55022 conducted EMI requirements. It has multi-protection function as open circuit protection, short-circuit protection, cycle by cycle current limit and over-temperature protection, etc.

ELECTRICAL SPECIFICATION

Parameter	Symbol	Value	Units
Input Voltage	V_{IN}	85 to 265	VAC
Output Voltage	V_{OUT}	5	V
Output Current	I_{OUT}	2.4	A
Output Power	P_{OUT}	12	W
Efficiency (full load)	η	>83	%

FEATURES

- Primary-Side Control without Optocoupler or Secondary Feedback Circuit
- Precise Constant Current and Constant Voltage Control (CC/CV)
- Variable Off-Time Peak Current Control
- 700V High-Voltage Current Source
- 20mW No-Load Power Consumption
- Programmable Cable Compensation
- Programmable Current Limit and Maximum Secondary Duty Cycle
- Programmable FB Voltage Sensing Point
- Multiple Protection Features: OVP, OCKP, OLP, OTP, VCC UVLO
- Low Cost and Simple External Circuit
- Available in a SOIC8-7A Package

APPLICATIONS

- Appliance Power Supplies
- Adapters for Handheld Electronics
- Stand-By and Auxiliary Power Supplies

All MPS parts are lead-free and adhere to the RoHS directive. For MPS green status, please visit MPS website under Quality Assurance. "MPS" and "The Future of Analog IC Technology", are Registered Trademarks of Monolithic Power Systems, Inc.



Warning: Although this board is designed to satisfy safety requirements, the engineering prototype has not been agency approved. Therefore, all testing should be performed using an isolation transformer to provide the AC input to the prototype board.

EV023-S-00A EVALUATION BOARD



TOP VIEW

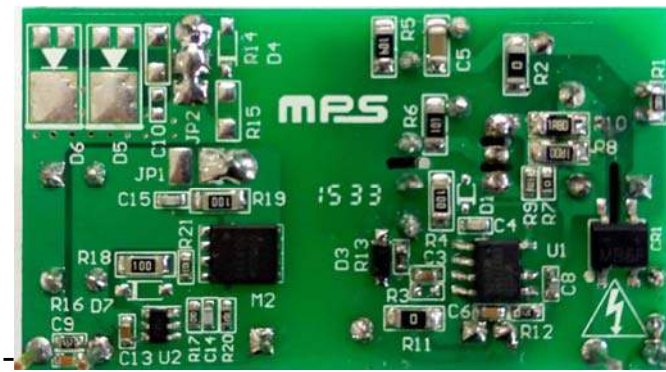

BOTTOM VIEW

(L x W x H) 55.5mm x 31mm x 21mm

Board Number	MPS IC Number
EV023-S-00A	MP023GS

EVALUATION BOARD SCHEMATIC

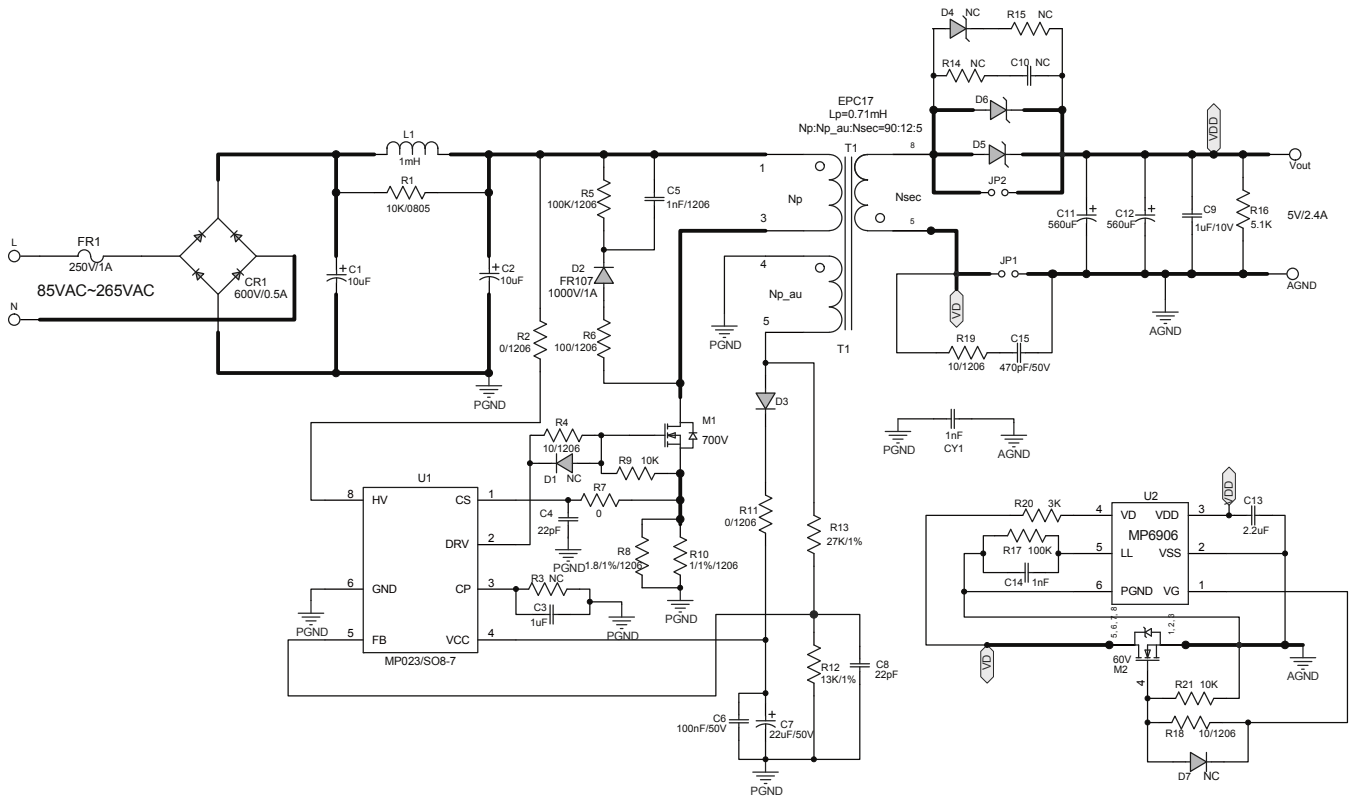

Figure 1—Schematic

PCB LAYOUT (SINGLE-SIDED)

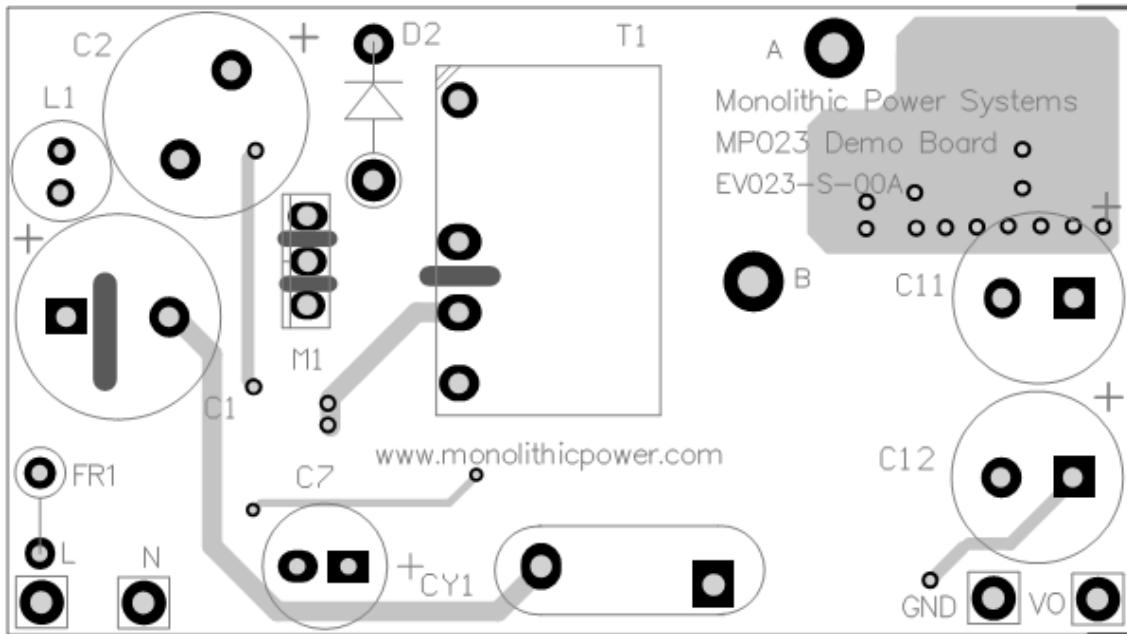

Figure 2—Top Layer

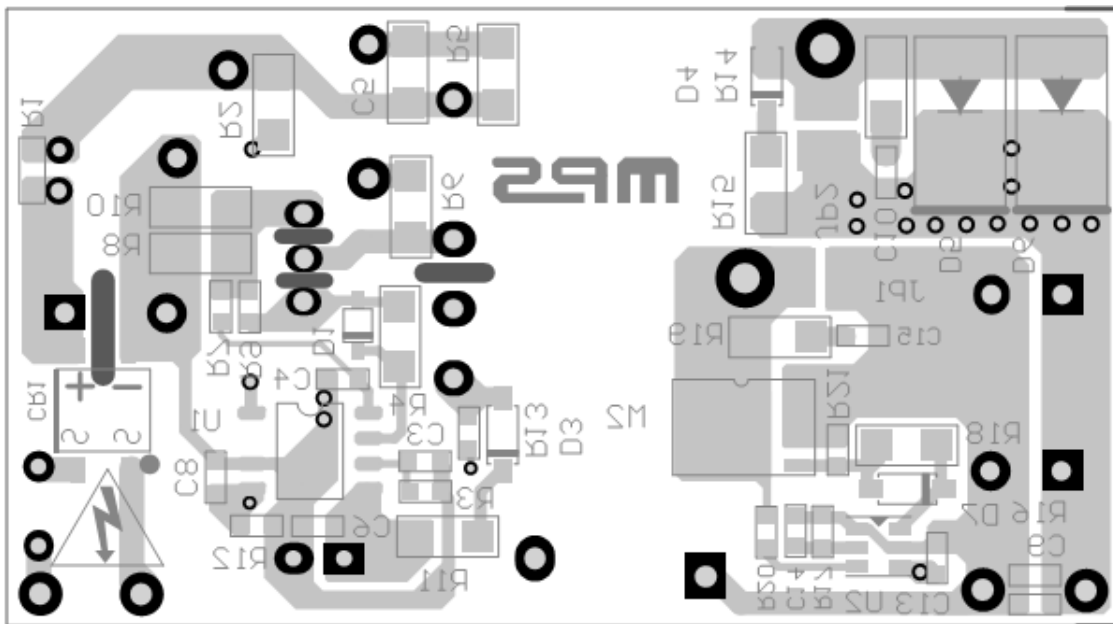

Figure 3—Bottom Layer

CIRCUIT DESCRIPTION

The EV023-S-00A is configured in a single-stage Flyback topology, it uses primary-side-control which can mostly simplify the schematic and get a cost effective BOM. It can also achieve accurate constant voltage and constant current.

FR1 and CR1 compose the input stage. FR1 is used to protect for the component failure or some excessive short events.

C1, L1 and C2 compose π filter to guarantee the conducted EMI meet standard EN55022.

R11, C6, C7 and D3 are used as Vcc power supply.

U1 and its peripheral components combine the primary side control circuit. M1 is the power mosfet. R5, R6, D2 and C5 compose the snubber circuit to reduce drain-source voltage spike.

CY1 is Y capacitor lowering common mode noise to make sure there is enough EMI margin. T1 is power transformer, the structure of which is also very important to pass EMI test.

U2 is the synchronous rectifier controller and M2 is the synchronous rectifier (SR). The SR is designed for better efficiency with its peripheral components. If there is no tough requirement of efficiency, the synchronous rectifier can be replaced by low cost schottky diode (D5 and D6). R19 and C15 is the snubber to depress voltage spike on SR.

C9, C11 and C12 is the output capacitor. C11 and C12 is electrolytic capacitor to filter low frequency ripple. C9 is ceramic capacitor to filter high frequency ripple introduced by switching frequency. R16 is dummy load, which is used for good regulation at no load.

EV023-S-00A BILL OF MATERIALS

Qty	Ref	Value	Description	Package	Manufacturer	Manufacturer_P/N
4	AGND, L, N, Vout		1.0mm 'Connector;		Any	
2	C1, C2	10 μ F	Electrolytic Capacitor; 400V;Electrolytic	DIP	Ltec	TY series, 400V/10uF
1	C3	1 μ F	Ceramic Capacitor; 25V;X5R;0603;	0603	TDK	C1608X5R1E105K
2	C4, C8	22pF	Ceramic Capacitor; 50V;C0G;0603;	0603	muRata	GRM1885C1H220JA01D
1	C5	1nF/1206	Ceramic Capacitor; 630V;U2J	1206	Murata	GRM31A7U2J102JW31D
1	C6	100nF/50V	Ceramic Capacitor; 50V;X7R	0603	Murata	GCJ188R71H104KA12D
1	C7	22 μ F/50V	Electrolytic Capacitor; 50V;Electrolytic;DIP	DIP	Jianghai	CD281L-50V22
1	C9	1 μ F/10V	Ceramic Capacitor; 10V;X7R	0603	Murata	GRM188R71A105KA61D
0	C10	NC	No Connected			
2	C11, C12	560 μ F	Electrolytic Capacitor; 6.3V;Electrolytic;DIP	DIP	Jianghai	HEN0J561MB12
1	C13	2.2 μ F	Ceramic Capacitor; 10V;X7R;0603;	0603	muRata	GRM188R71A225KE15D
1	C14	1nF	Ceramic Capacitor; 16V;X7R	0603	Murata	GRM188R71C102KA01D
1	C15	470pF/50V	Ceramic Capacitor; 50V;C0G;0603	0603	muRata	GRM1885C1H471JA01D
1	CR1	MB6F	Diode;600V;0.5A	SOP-4	Bangdayuan	MB6F
1	CY1	1nF	Y Capacitor; 250V;20%	DIP	Hongke	JYK08F102ML72N
0	D1, D4, D5, D6, D7	NC	No Connected			
1	D2	FR107	Diode;1000V;1A	DO-41	Diodes	FR107
1	D3	S1ML	Diode;1000V;1.0A;	SOD-123	Taiwan Semi	S1ML
1	FR1	392110000 00	Fuse;250V;1A	DIP	Little Fuse	39211000000
1	JP1		Connector, Open ; 开路			
1	JP2		Connector, Shorted with solder; 用锡短路			

EV023-S-00A BILL OF MATERIALS (continued)

Qty	Ref	Value	Description	Package	Manufacturer	Manufacturer_P/N
1	L1	1mH	Inductor;1mH; 6;250mA	DIP	Würth	7447462102
1	M1	CS6N70 A3D-G	N-Channel Mosfet; 700V;1.5Ohm/10V	TO-251	Huajing	CS6N70A3D-G
1	M2	AP9990 GMT-HF	N-Channel Mosfet; 60V;	PMPAK, 5*6	APEC	AP9990GMT-HF
1	R1	10k/0805	Film Resistor;1%	0805	Yageo	RC0805FR-0710KL
2	R2, R11	0/1206	Film Resistor;5%, Film Resistor;5%;	1206	Yageo	RC1206JR-070RL
0	R3,R14, R15	NC	No Connected			
3	R4, R18, R19	10/1206	Film Resistor;5%	1206	Yageo	RC1206JR-0710R
1	R5	100k/120 6	Film Resistor;5%	1206	Yageo	RC1206JR-07100KL
1	R6	100/1206	Film Resistor;5%;1/4W	1206	Yageo	RC1206JR-07100RL
1	R7	0	Film Resistor;5%;	0603	Yageo	RC0603JR-070RL
1	R8	1.8/1%/1 206	Resistor;1%;1/4W	1206	Yageo	RC1206FR-071R8L
2	R9, R21	10k	Film Resistor;5%;	0603	Yageo	RC0603JR-0710K
1	R10	1/1%/120 6	Resistor;1%	1206	Royalohm	1206F100KT5E
1	R12	13k/1%	Film Resistor;1%;	0603	Yageo	RC0603FR-0713KL
1	R13	27k/1%	Film Resistor;1%;	0603	Yageo	RC0603FR-0727KL
1	R16	5.1k	Film Resistor;1%;	0603	Yageo	RC0603FR-075K1L
1	R17	100k	Film Resistor;1%;	0603	Yageo	RC0603FR-07100KL
1	R20	3k	Film Resistor;1%;	0603	Yageo	RC0603FR-073KL
1	T1	FX0429	Transformer, 0.71mH. N1:N2:N3=90:12:5	EPC17 Vertical	Emei	FX0429
1	U1	MP023	PSR Flyback Controller	SOIC8- 7A	MPS	MP023GS R1
1	U2	MP6906	SR Driver	SOT23-6	MPS	MP6906J R1

Note:

 (1) Würth transformer sample request please login on website: www.we-online.com

Transformer Specification

Primary inductance: 0.71mH

Leakage inductance: 15uH

Core/Bobbin:EPC17/EPC17 Vertical

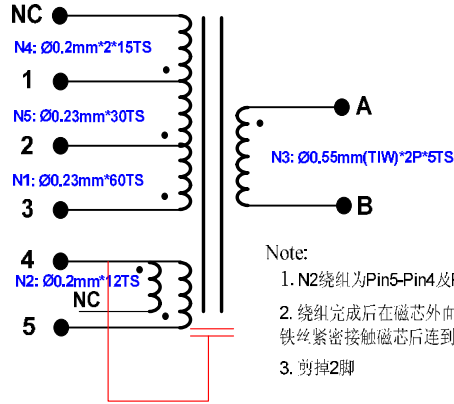

- Note:
1. N2绕组为Pin5-Pin4及Pin4-NC双线并绕
 2. 绕组完成后在磁芯外向加几圈铁丝，铁丝紧密接触磁芯后连到4脚
 3. 剪掉2脚

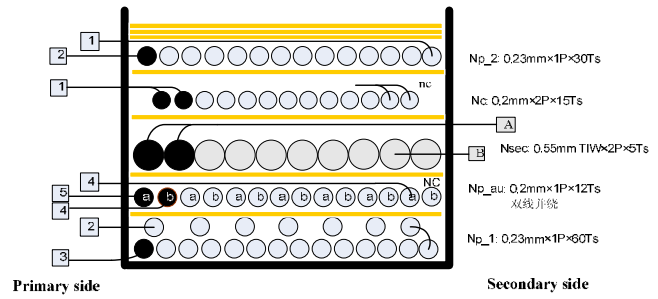

- Note:
1. N2 is wound from Pin5-Pin4 and Pin4-NC in parallel;
 2. Connect the core with a naked iron wire before varnish and tie the wire to Pin4.
 3. Cut Pin2.

Tape (T) 胶带	Sequence 绕组顺序	Start-End 始末脚位	Sire Dia 线径 (φ)	Turns 圈数 (T)	Winding Way 绕线方式	Tube 套管
0						
1	N1	3—> 2	0.23mm*1	60	Tightly for first layer and evenly for second layer	None
1	N2	5—> 4 4—> NC	0.2mm*1 0.2mm*1	12	Evenly	None
1	N3	A—> B	0.55mm*2 TIW	5	Evenly	None
1	N4	1—> NC	0.2mm*2	15	Evenly	None
1	N5	2—> 1	0.23mm*1	30	Evenly	None

Electrical Specifications

Electrical Strength	60 second, 60Hz, from PRI. to SEC.	3000VAC
	60 second, 60Hz, from PRI. to CORE.	500VAC
	60 second, 60Hz, from SEC. to CORE.	3000VAC
Primary Inductance	Pins 1 - 3, all other windings open, measured at 60kHz, 0.1 VRMS	0.71mH±10%
Primary Leakage Inductance	Pins 1 - 3 with all other pins shorted, measured at 60kHz. 0.1 VRMS	15µH±10%

Materials

Item	Description
1	Core: EPC17
2	Bobbin: EPC17, 5PIN
3	Wire:Φ0.23mm,, 2UEW, Class B
4	Wire:Φ0.2mm,, 2UEW, Class B
5	Triple Insulation Wire: Φ0.55mm TIW
6	Tape: 8.0mm(W)×0.06mm(TH)
7	Varnish: JOHN C. DOLPH CO, BC-346A or equivalent
8	Solder Bar: CHEN NAN: SN99.5/Cu0.5 or equivalent

EVB TEST RESULTS

Performance Data

T_A=25°C, unless otherwise noted.

Efficiency

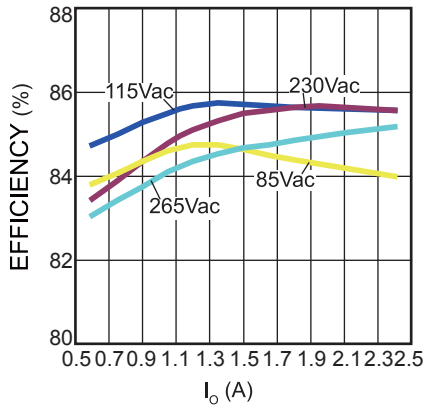

No Load Consumption

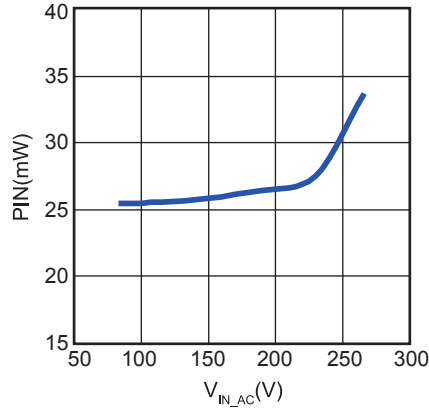

Line Regulation

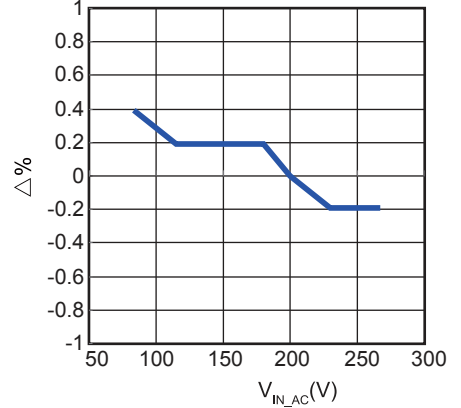

CV/CC

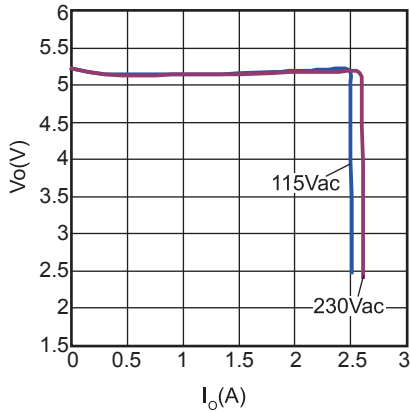

Electric Strength Test

Primary circuit to secondary circuit electric strength testing was completed according to IEC61000-4-2. Input and output was shorted respectively. 3000VAC/50Hz sine wave applied between input and output for 1min, and operation was verified.

Conducted EMI Test

Test with 230Vac input and full load condition

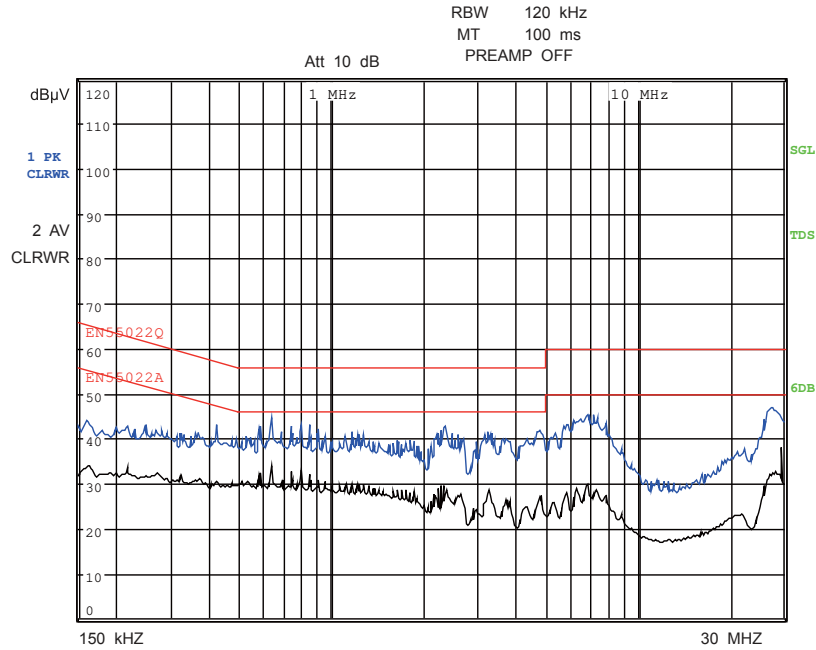

230Vac, 50Hz, Maximum Load, L Line, Output GND floats, EN55022 Limits

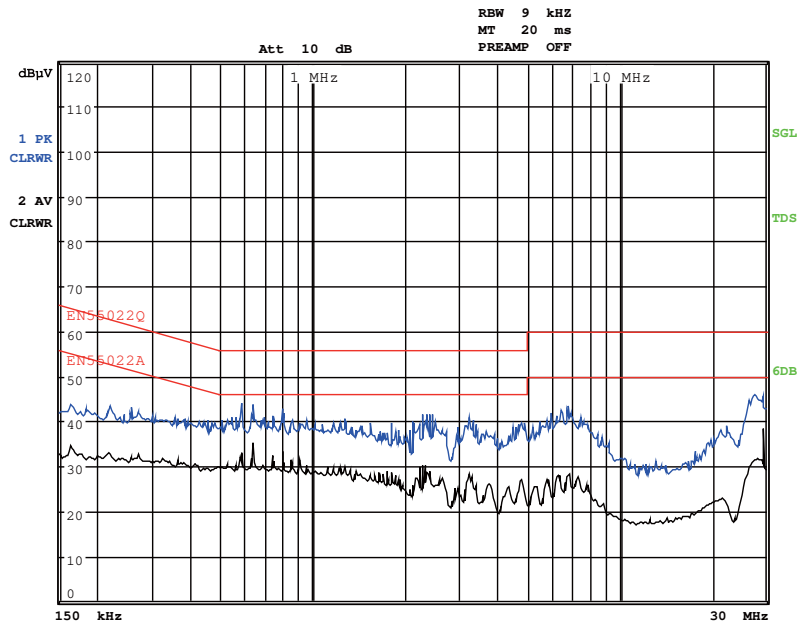

230Vac, 50Hz, Maximum Load, N Line, Output GND floats, EN55022 Limits

Conducted EMI Test (continued)

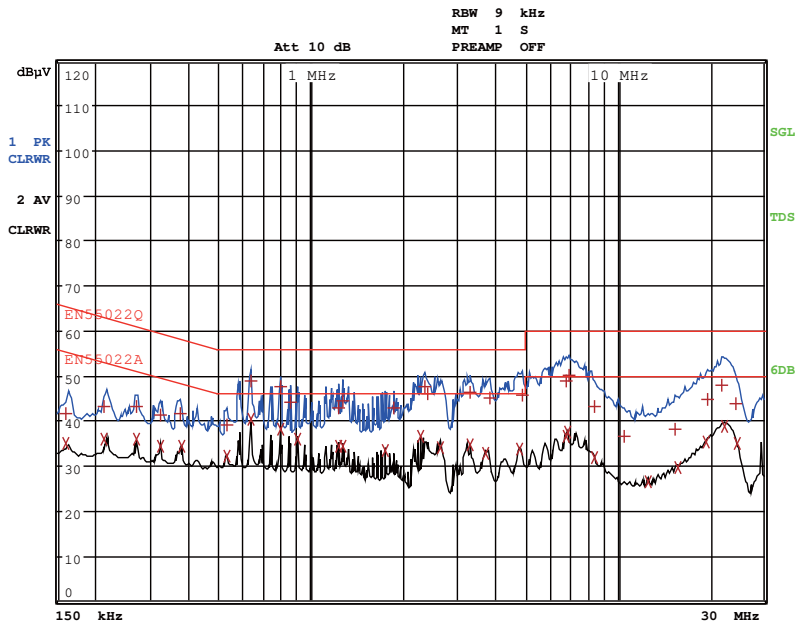

230Vac, 50Hz, Maximum Load, L Line, Output GND connects to Earth, EN5022 Limits

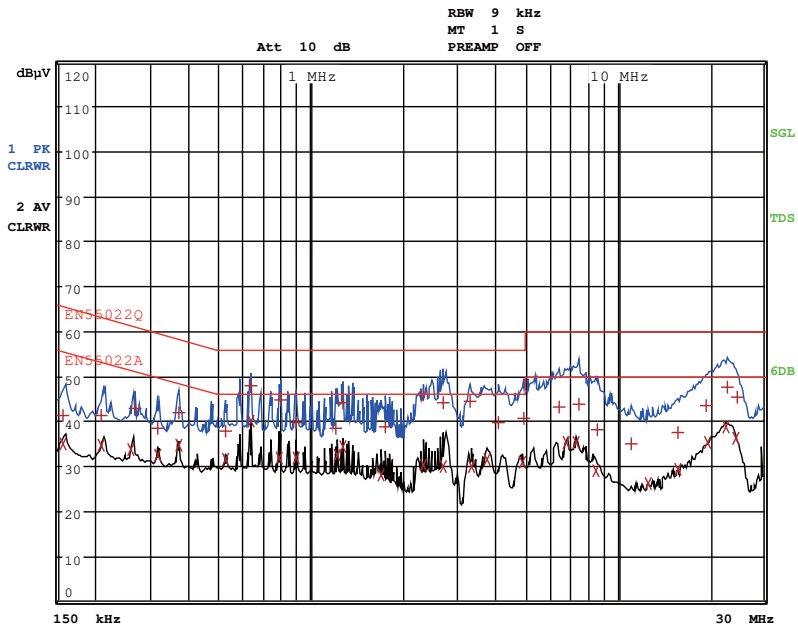

230Vac, 50Hz, Maximum Load, N Line, Output GND connects to Earth, EN5022 Limits

Thermal Test

Test with 85Vac input and full load condition. PCB layout is with 1Oz copper. Ambient temperature is 25°C.

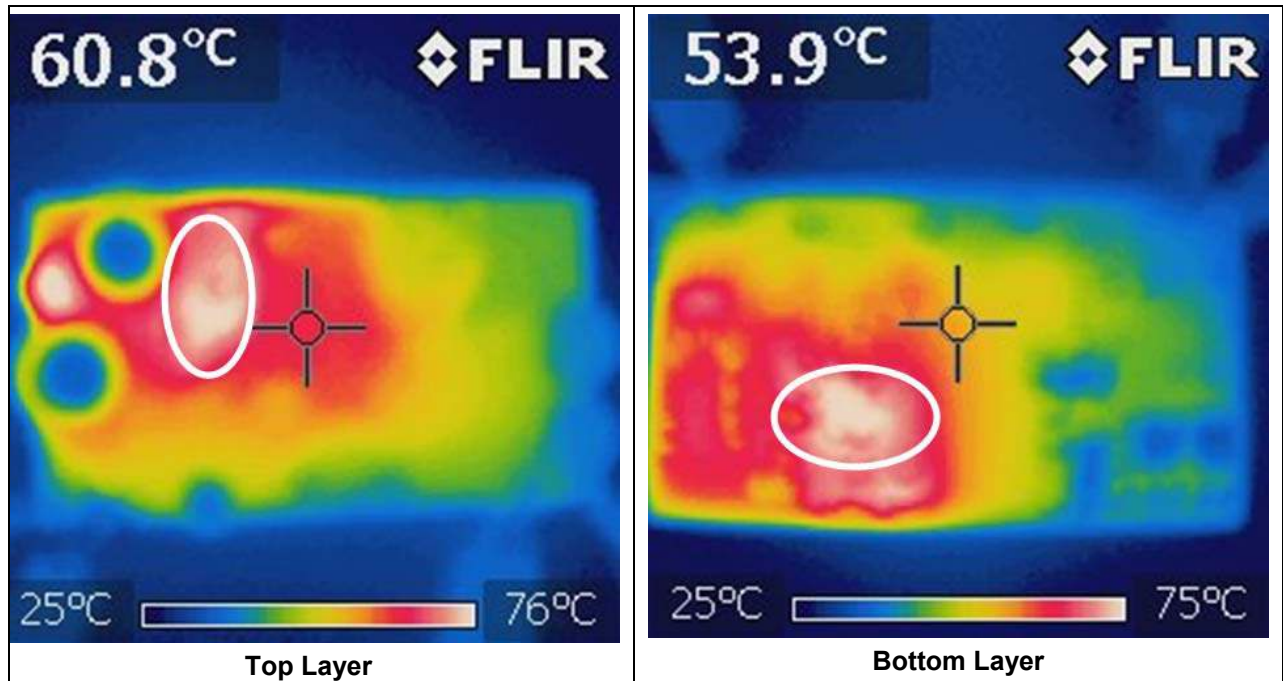

EVB TEST RESULTS

Performance waveforms are tested on the evaluation board.

$V_{IN}=115VAC/60Hz$, $V_{OUT}=5V$, $I_{OUT}=2.4A$, $T_A=25^{\circ}C$, unless otherwise noted.

Steady State

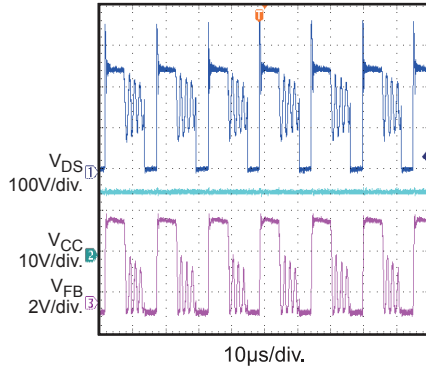

Turn On Delay

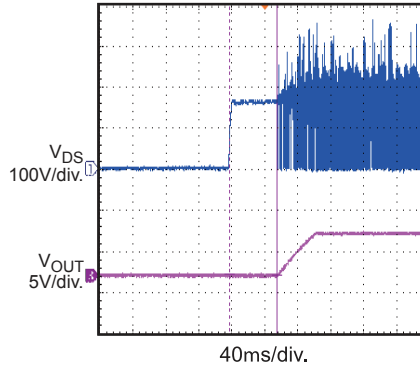

Output Rise Time

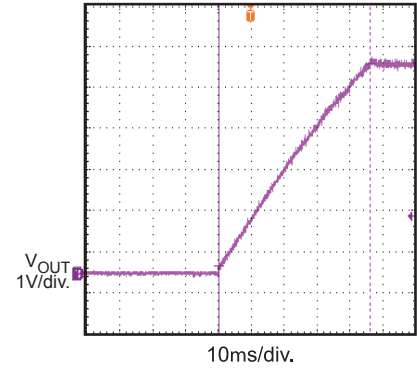

Output Ripple

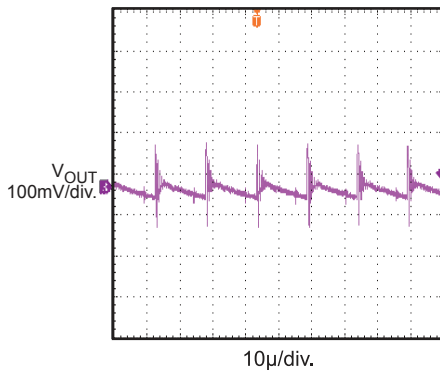

SCP Enter

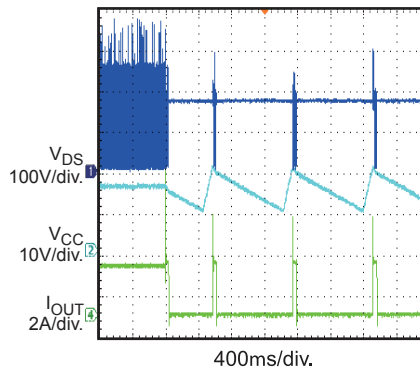

SCP Recovery

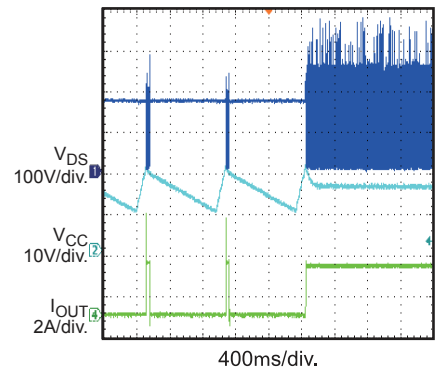

OCP Enter

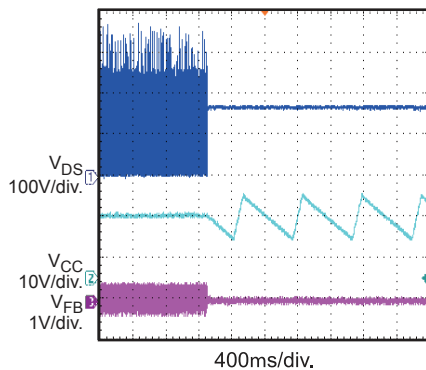

OCP Recovery

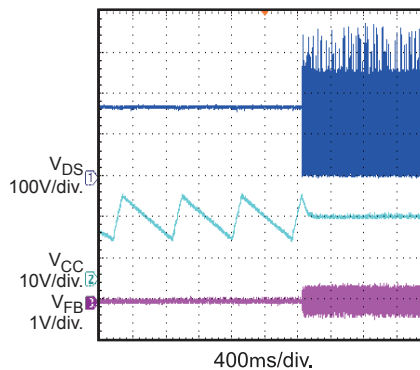

Load Transient

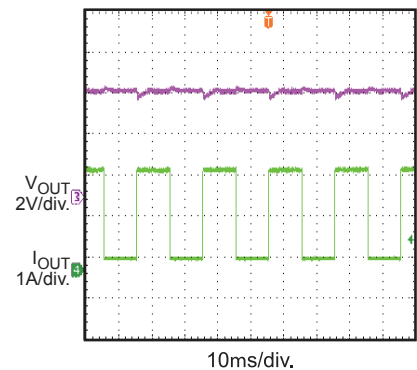

EVB TEST RESULTS *(continued)*

Performance waveforms are tested on the evaluation board.

$V_{IN}=230VAC/50Hz$, $V_{OUT}=5V$, $I_{OUT}=2.4A$, $T_A=25^{\circ}C$, unless otherwise noted.

Steady State

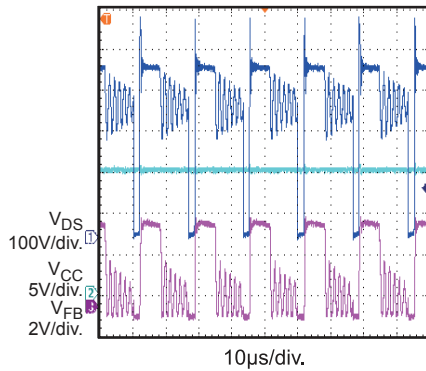

Turn On Delay

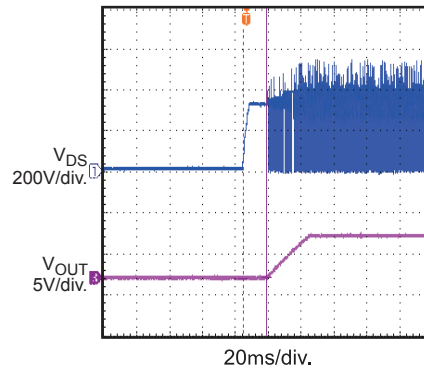

Output Rise Time

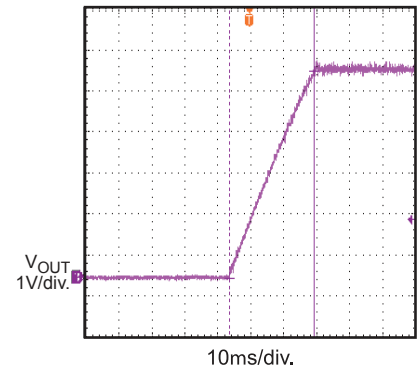

Output Ripple

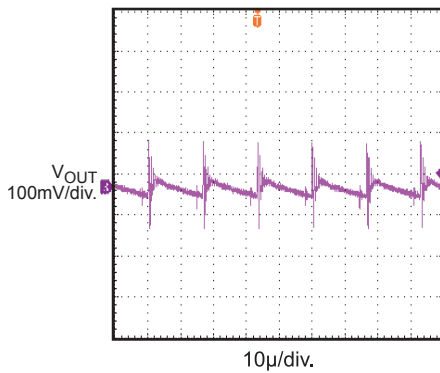

SCP Enter

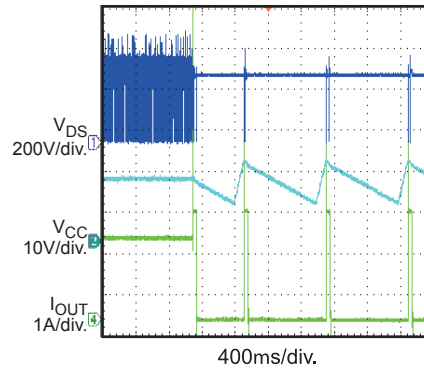

SCP Recovery

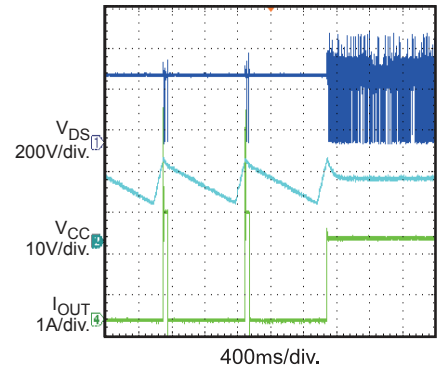

OckP Enter

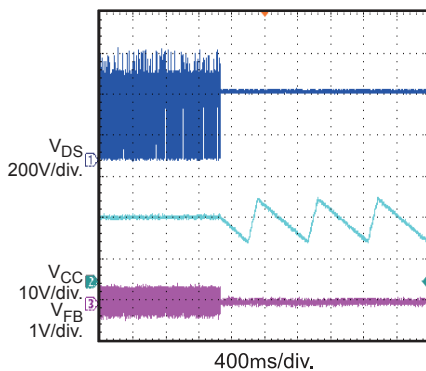

OckP Recovery

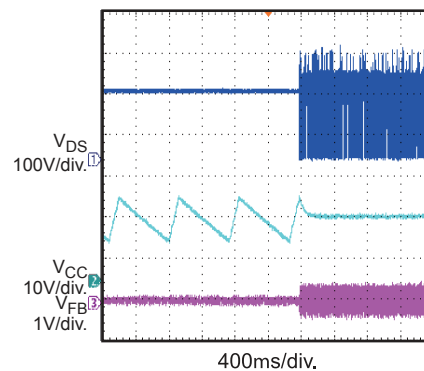

Load Transient

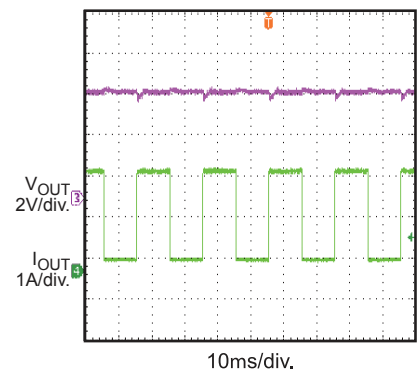

QUICK START GUIDE

1. Connect the positive and negative terminals of the output to the load.
2. Connect the Line and Neutral terminals of the power supply to L and N port
3. Turn the power supply on. The board will automatically start up.

NOTICE: The information in this document is subject to change without notice. Please contact MPS for current specifications. Users should warrant and guarantee that third party Intellectual Property rights are not infringed upon when integrating MPS products into any application. MPS will not assume any legal responsibility for any said applications.