

SAC-5P-M12MS/ 5,0-PVC/M12FS - Sensor/actuator cable



1417521

<https://www.phoenixcontact.com/us/products/1417521>

Please be informed that the data shown in this PDF document is generated from our online catalog. Please find the complete data in the user documentation. Our general terms of use for downloads are valid.



Sensor/actuator cable, 5-position, Plug straight M12, coding: A, connected with unwired, on Socket straight M12, coding: A, cable length: 5 m

Your advantages

- Easy and safe: 100% electrically tested plug-in components

Commercial data

Item number	1417521
Packing unit	1 pc
Minimum order quantity	20 pc
Note	Made to order (non-returnable)
Sales key	BF03
Product key	BF1CDA
GTIN	4055626117331
Weight per piece (including packing)	218 g
Weight per piece (excluding packing)	171.6 g
Customs tariff number	85444290
Country of origin	DE

SAC-5P-M12MS/ 5,0-PVC/M12FS - Sensor/actuator cable



1417521

<https://www.phoenixcontact.com/us/products/1417521>

Technical data

Product properties

Product type	Sensor/actuator cable
Number of positions	5
Application	Standard
No. of cable outlets	1
Shielded	no
Coding	A

Insulation characteristics

Overvoltage category	II
Degree of pollution	3

Material specifications

Flammability rating according to UL 94	HB
Seal material	NBR
Material of grip body	TPU, hardly inflammable, self-extinguishing
Contact material	CuSn
Contact surface material	Ni/Au
Contact carrier material	TPU GF
Material for screw connection	Zinc die-cast, nickel-plated

Electrical properties

Contact resistance	$\leq 5 \text{ m}\Omega$
Insulation resistance	$\geq 100 \text{ M}\Omega$
Nominal voltage U_N	48 V AC
	60 V DC
Nominal current I_N	4 A
Protective circuit	unwired

Mechanical properties

Mechanical data

Insertion/withdrawal cycles	≥ 100
-----------------------------	------------

Signaling

Status display	No
Status display present	No

Connector

Connection 1

Type	Plug straight M12
Number of positions	5

SAC-5P-M12MS/ 5,0-PVC/M12FS - Sensor/actuator cable



1417521

<https://www.phoenixcontact.com/us/products/1417521>

Coding type	A
Number of positions	5

Connection 2

Type	Socket straight M12
Number of positions	5
Coding type	A
Number of positions	5

Cable/line

Cable length	5 m
--------------	-----

PVC black [PVC]

Dimensional drawing	
Cable weight	51 kg/km
UL AWM Style	2464 / 1729 (80°C/300 V)
Number of positions	5
Shielded	no
Cable type	PVC black [PVC]
Conductor structure signal line	19x 0.15 mm
AWG signal line	22
Conductor cross section	5x 0.34 mm ² (Signal line)
Wire diameter incl. insulation	1.26 mm ±0.05 mm
External cable diameter	5 mm ±0.15 mm
Outer sheath, material	PVC
External sheath, color	black RAL 9005
Conductor material	Bare Cu litz wires
Material wire insulation	PVC
Single wire, color	brown, white, blue, black, green-yellow
Thickness, insulation	≥ 0.23 mm (Core insulation)
Thickness, outer sheath	≥ 0.76 mm
Overall twist	5 wires around filler to the core
Max. conductor resistance	max. 57 Ω/km (at 20 °C)
Insulation resistance	≥ 200 MΩ*km (at 20 °C)
Nominal voltage, cable	≤ 300 V
Test voltage	≥ 3000 V
Minimum bending radius, fixed installation	5 x D
Minimum bending radius, flexible installation	10 x D

SAC-5P-M12MS/ 5,0-PVC/M12FS - Sensor/actuator cable



1417521

<https://www.phoenixcontact.com/us/products/1417521>

Flame resistance	As per UL-Style 2464
Resistance to oil	in accordance with DIN EN 60811-2-1
Ambient temperature (operation)	-25 °C ... 80 °C (cable, fixed installation)
	-10 °C ... 80 °C (Cable, flexible installation)

Environmental and real-life conditions

Ambient conditions

Degree of protection	IP65
	IP68
Ambient temperature (operation)	-25 °C ... 90 °C (Plug / socket)

Standards and regulations

Standard designation	M12 connector
Standards/specifications	IEC 61076-2-101

SAC-5P-M12MS/ 5,0-PVC/M12FS - Sensor/actuator cable



1417521

<https://www.phoenixcontact.com/us/products/1417521>

Drawings

Circuit diagram



Schematic diagram

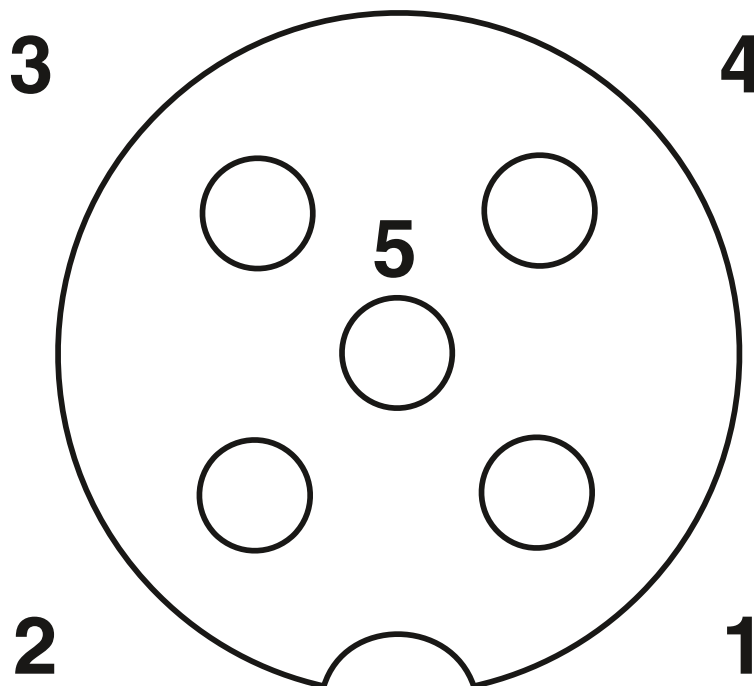

Pin assignment M12 socket, 5-pos., A-coded, socket side view

SAC-5P-M12MS/ 5,0-PVC/M12FS - Sensor/actuator cable



1417521

<https://www.phoenixcontact.com/us/products/1417521>

Dimensional drawing

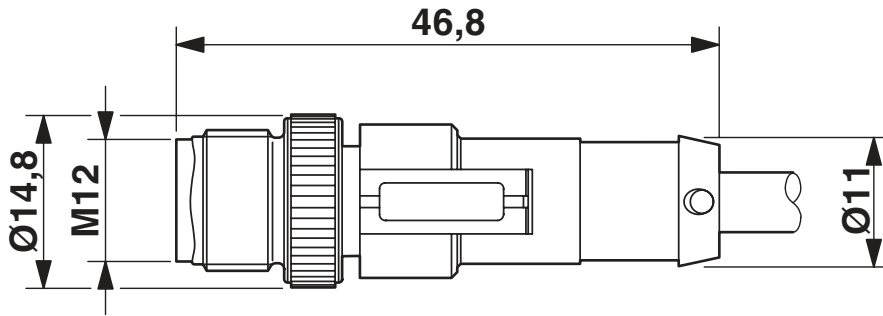

Plug, M12 x 1, straight, shielded

Dimensional drawing

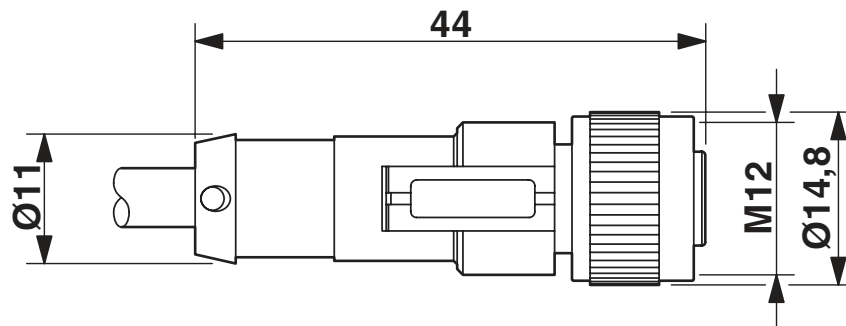

M12 x 1 socket, straight

SAC-5P-M12MS/ 5,0-PVC/M12FS - Sensor/actuator cable

1417521

<https://www.phoenixcontact.com/us/products/1417521>

Schematic diagram

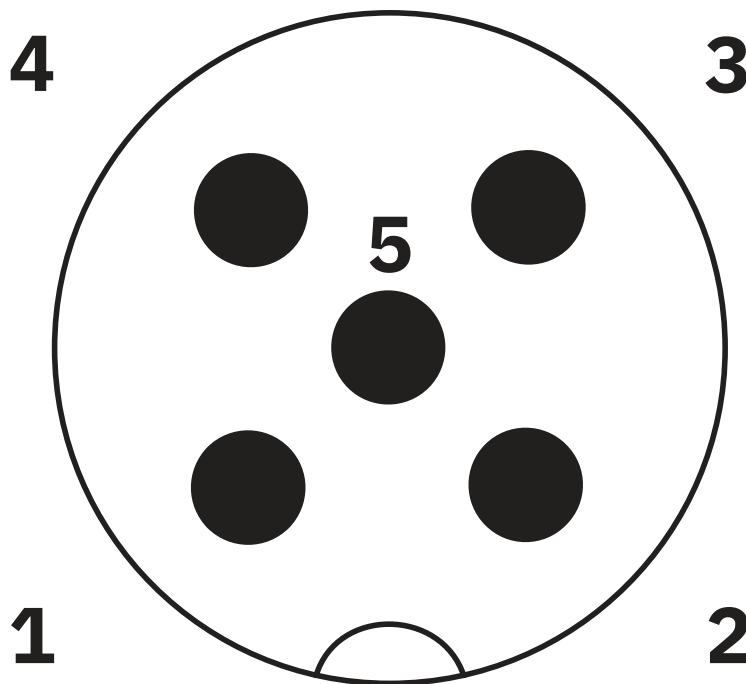

Pin assignment M12 male connector, 5-pos., A-coded, male side

SAC-5P-M12MS/ 5,0-PVC/M12FS - Sensor/actuator cable





1417521

<https://www.phoenixcontact.com/us/products/1417521>

Approvals

To download certificates, visit the product detail page: <https://www.phoenixcontact.com/us/products/1417521>

 UL Listed Approval ID: FILE E 221474				
	Nominal voltage U_N	Nominal current I_N	Cross section AWG	Cross section mm^2
	125 V	4 A	-	-

 cUL Listed Approval ID: FILE E 221474				
	Nominal voltage U_N	Nominal current I_N	Cross section AWG	Cross section mm^2
	125 V	4 A	-	-

cULus Listed				
---------------------	--	--	--	--

SAC-5P-M12MS/ 5,0-PVC/M12FS - Sensor/actuator cable



1417521

<https://www.phoenixcontact.com/us/products/1417521>

Classifications

ECLASS

ECLASS-11.0	27060311
ECLASS-12.0	27060311
ECLASS-13.0	27060311

ETIM

ETIM 8.0	EC001855
----------	----------

UNSPSC

UNSPSC 21.0	26121600
-------------	----------

SAC-5P-M12MS/ 5,0-PVC/M12FS - Sensor/actuator cable



1417521

<https://www.phoenixcontact.com/us/products/1417521>

Environmental product compliance

China RoHS	Environmentally friendly use period: unlimited = EFUP-e
	No hazardous substances above threshold values

SAC-5P-M12MS/ 5,0-PVC/M12FS - Sensor/actuator cable



1417521

<https://www.phoenixcontact.com/us/products/1417521>

Accessories

PROT-M12 FS-PA-CHAIN - Sealing cap

1430873

<https://www.phoenixcontact.com/us/products/1430873>

M12 sealing cap made of plastic with fixing band, for sensor cables, for free M12 plugs



SAC-M12-EXCLIP-M - Locking clip

1558988

<https://www.phoenixcontact.com/us/products/1558988>

Locking clip for the pin side of sensor/actuator cables with M12 connector and M12 connectors for assembly, for knurl diameter: 15 mm or for Allen key with a wrench size of 14 mm, prevents the disconnection of plug-in connections without tools



SAC-5P-M12MS/ 5,0-PVC/M12FS - Sensor/actuator cable



1417521

<https://www.phoenixcontact.com/us/products/1417521>

PABA WH/23 - Insert label

1013779

<https://www.phoenixcontact.com/us/products/1013779>



Insert label, Strip, white, unlabeled, can be labeled with: CMS-P1-PLOTTER, mounting type: slide-on, cable diameter range: 1.5 ... 35 mm, lettering field size: 23 x 4 mm, Number of individual labels: 20

PABA YE/23 - Insert label

1013782

<https://www.phoenixcontact.com/us/products/1013782>



Insert label, Strip, yellow, unlabeled, can be labeled with: CMS-P1-PLOTTER, mounting type: slide-on, cable diameter range: 1.5 ... 35 mm, lettering field size: 23 x 4 mm, Number of individual labels: 20

SAC-5P-M12MS/ 5,0-PVC/M12FS - Sensor/actuator cable



1417521

<https://www.phoenixcontact.com/us/products/1417521>

B-STIFT - Marker pen

1051993

<https://www.phoenixcontact.com/us/products/1051993>



Marker pen, for manual labeling of unprinted Zack strips, smear-proof and waterproof, line thickness 0.5 mm

PROT-M12 MS-PA-CHAIN - Screw plug

1430899

<https://www.phoenixcontact.com/us/products/1430899>



M12 sealing cap with fixing band, for sensor cables, for free M12 sockets

SAC-5P-M12MS/ 5,0-PVC/M12FS - Sensor/actuator cable



1417521

<https://www.phoenixcontact.com/us/products/1417521>

SAC-M12-EXCLIP-F - Locking clip

1558991

<https://www.phoenixcontact.com/us/products/1558991>



Locking clip for the socket side of sensor/actuator cables with M12 connector and M12 connectors for assembly, for knurl diameter: 15 mm or for Allen key with a wrench size of 14 mm, prevents the disconnection of plug-in connections without tools

TSD 04 SAC - Torque screwdriver

1208429

<https://www.phoenixcontact.com/us/products/1208429>



Torque screwdriver, with preset torque of 0.4 Nm and 4 mm hexagonal drive for M12 connectors

SAC-5P-M12MS/ 5,0-PVC/M12FS - Sensor/actuator cable



1417521

<https://www.phoenixcontact.com/us/products/1417521>

TSD-M 1,2NM - Torque screwdriver

1212224

<https://www.phoenixcontact.com/us/products/1212224>



Torque screw driver, accuracy as per EN ISO 6789 standard, adjustable from 0.3 - 1.2 Nm

TSD-M SAC-BIT ADAPTER - Adapter insert

1212600

<https://www.phoenixcontact.com/us/products/1212600>



Adapter bit for TSD-M...torque tools, E6.3-1/4" drive with 4 mm hexagon to accommodate SAC bits

SAC-5P-M12MS/ 5,0-PVC/M12FS - Sensor/actuator cable



1417521

<https://www.phoenixcontact.com/us/products/1417521>

SAC BIT M12-D15 - Tool

1208432

<https://www.phoenixcontact.com/us/products/1208432>



Nut for assembling sensor/actuator cables with M12 connector and M12 connectors for assembly, with a knurl diameter of 15 mm, for 4 mm hexagonal drive

Phoenix Contact 2023 © - all rights reserved

<https://www.phoenixcontact.com>

Phoenix Contact USA
586 Fulling Mill Road
Middletown, PA 17057, United States
(+717) 944-1300
info@phoenixcon.com