

Basics of Tactile Switches

General Knowledge of Tactile Switches

What is a Tactile Switches ?

A tactile switch allows electricity to flow in an electrical circuit by manually pressing the operating section. The switch is used to supply input signal to actuate a device or equipment. It is designed with a small footprint suited for mounting onto the surface of printed circuit boards (PCB) made to connect electronic components to form electronic circuits (Figure 1).



Figure 1 ● Tactile switches

The switch activates when pressed and then turns off when released. This action is called 'momentary action' and can only be performed at low voltage and low current. There are many different types of tactile switches, also known as tactile push switch or tact switch, used in a variety of applications including household appliances, office equipment, commercial equipment, and industrial machinery.

There are optional features such as size (external dimension), board mounting, and sealing structure for users to select for their applications. A tactile switch is literally a switch which users can "feel a click sense of touch".

Features

<Click response>

A click response of a button is the most characteristic feature of a tactile switch that lets users feel the response of the operation from a switch. A clicking feel is generated from the contact dome embedded in the switch. How large an operation stroke and how sharp a click sense of touch depends on the materials and shapes of the contact dome.

<High Durability>

The contact dome also acts as a movable contact in a tactile switch. The resistance value (contact resistance) which is generated between a movable contact and a fixed contact when a switch is turned on can be stabilized by using specific materials, surface processing, and shape enabling high durability capable of withstanding 100 thousand to 10 million times of use.

Basics of Tactile Switches

General Knowledge of Tactile Switches

Models

There are two types of tactile switches: Standard tactile switch and sealed tactile switch. The sealed tactile switches are dust protected and water resistant to withstand harsh environmental conditions. They are further sub-categorized into two types: PCB insert hole terminals type and PCB surface mounted terminals type. For PCB insert hole terminals type, terminals are inserted into holes on the PCB and are fixed by soldering. For PCB surface mounted terminals type, terminals are surface-mounted and soldered on the PCB. These switches can be transported in a standalone package, or using a taping packaging method where a carrier tape holds the switches in place with clearance between them.

Other variations include horizontal push button type, long-stroke type, and ultra subminiature type switches and many more, ranging from different shapes and specifications that cater to various applications (Figure 2).











	Standard type (Non-sealed type)	Sealed type
PCB insert hole terminals	 <p>Standard</p>  <p>Horizontal pushbutton</p>  <p>Hinge lever</p>	 <p>Standard</p>  <p>Radial taping package</p>
PCB surface mounted terminals	 <p>Standard</p>  <p>Ultra subminiature</p>  <p>Long stroke</p>	 <p>Standard</p>  <p>Low-profile</p>  <p>Medium-stroke</p>

Figure 2 ● Type of Tactile switches

Basics of Tactile Switches

General Knowledge of Tactile Switches

Basic Structure

In general, typical tactile switch consists of: a cover (1), a plunger (2), a contact dome (3), and a base (4) (Figure 3).

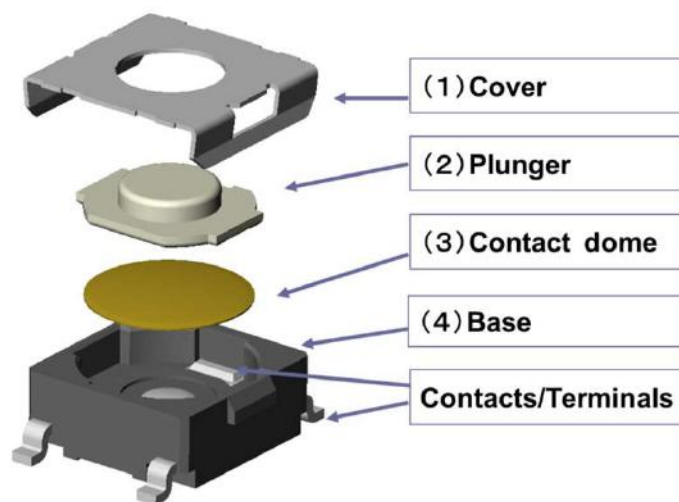

Figure 3 ● Basic structure of tactile switches

(1) Cover

The cover protects the switch's internal mechanisms. Basic covers are typically made of metal and are swaged to the base. There are also covers that include a ground terminal for static electricity protection (Figure 4).

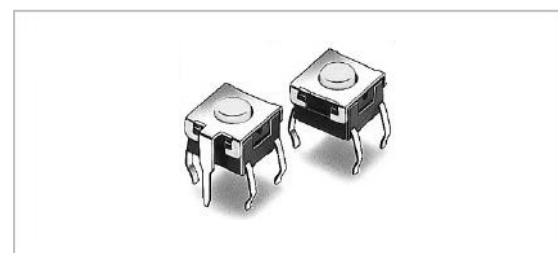

Figure 4 ● Cover w/ ground terminal (left) and cover w/o ground terminal (right)

(2) Plunger

The switch plunger is a button pusher (pushed manually) to activate the switch. It relays the pressed force to the contact dome. The plunger surface is arranged with a flat surface or a projected surface. Our major tactile switches have options of both flat and projected type (Figure 5). Typically, plungers are made of molded resin but some use rubber material to allow long strokes (Figure 6).



Figure 5 ● Flat type plunger (left) and projected type plunger(right)

Basics of Tactile Switches

General Knowledge of Tactile Switches

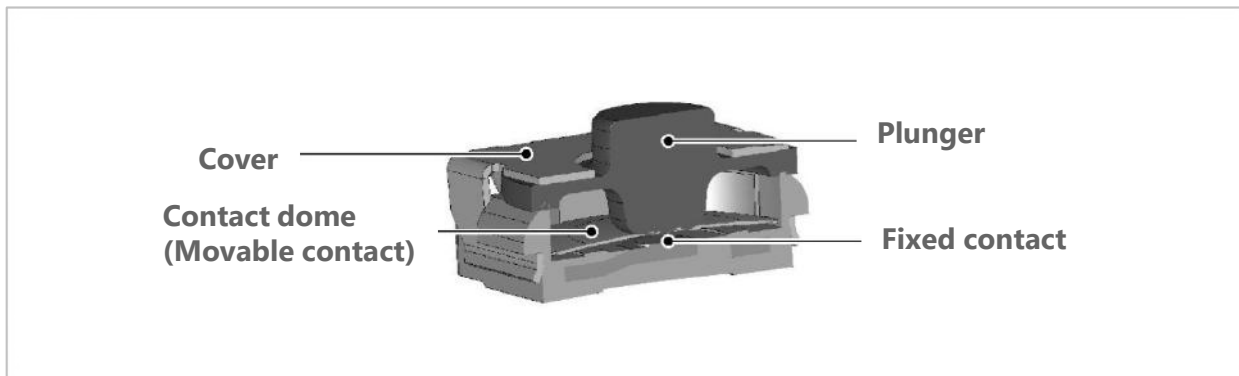

Figure 6 ● *Medium-stroke tactile switch using a rubber plunger*

(3) Contact dome

The contact dome generates the click feel and also acts as a movable contact. The dome reverses its shape when a certain operating force is applied to the plunger, and electrically connects the two fixed contacts to power the circuit, and then as soon as the operating force is removed, the dome returns to its original off state. There are metal contact domes and rubber contact domes. The metal contact dome reduces the operation stroke enabling sharper tactile response. The rubber contact dome, on the other hand, increases the operation stroke, providing a softer tactile response.

(4) Base

The base is made of molded resin, and metal contacts and terminals are molded integrally with the base to make up a single component on which all other switch parts are assembled on. Resin material is used to withstand soldering heat. The contacts and terminals are particularly important. The two fixed contacts each connects to the terminals protruding from the base case. These terminals are soldered to a PCB to electrically and mechanically connect the switch and the PCB.

Basics of Tactile Switches

General Knowledge of Tactile Switches

Applications

- Condition settings and operation of commercial equipment and industrial machinery

Tactile switches are used in operating units of devices and equipment to enable setting of operating modes and operating conditions as well as to start and stop the operation. Devices and equipment include temperature controller, air conditioning systems, inverter control panels, and measuring instruments and medical devices.

- Mode settings and operation of household appliances and office equipment

Tactile switches are used in control panels of devices such as printers and multifunction printers to enable setting of operating modes and operating conditions as well as to start and stop the operation. Sealed tactile switches, which are water resistant, are used in dishwashers and washing machines.

Please check each region's Terms & Conditions by region website.

OMRON Corporation

Electronic and Mechanical Components Company

Regional Contact

Americas

<https://www.components.omron.com/>

Asia-Pacific

<https://ecb.omron.com.sg/>

Korea

<https://www.omron-ecb.co.kr/>

Europe

<http://components.omron.eu/>

China

<https://www.ecb.omron.com.cn/>

Japan

<https://www.omron.co.jp/ecb/>