



# 80960HA/HD/HT 32-Bit High-Performance Superscalar Processor

## Data Sheet

---

## Advance Information

### Product Features

- 32-Bit Parallel Architecture
  - Load/Store Architecture
  - Sixteen 32-Bit Global Registers
  - Sixteen 32-Bit Local Registers
  - 1.28 Gbyte Internal Bandwidth (80 MHz)
  - On-Chip Register Cache
- Processor Core Clock
  - 80960HA is 1x Bus Clock
  - 80960HD is 2x Bus Clock
  - 80960HT is 3x Bus Clock
- Binary Compatible with Other 80960 Processors
- Issue Up To 150 Million Instructions per Second
- High-Performance On-Chip Storage
  - 16 Kbyte Four-Way Set-Associative Instruction Cache
  - 8 Kbyte Four-Way Set-Associative Data Cache
  - 2 Kbyte General Purpose RAM
  - Separate 128-Bit Internal Paths For Instructions/Data
- 3.3 V Supply Voltage
  - 5 V Tolerant Inputs
  - TTL Compatible Outputs
- Guarded Memory Unit
  - Provides Memory Protection
  - User/Supervisor Read/Write/Execute
- 32-Bit Demultiplexed Burst Bus
  - Per-Byte Parity Generation/Checking
  - Address Pipelining Option
  - Fully Programmable Wait State Generator
  - Supports 8-, 16- or 32-Bit Bus Widths
  - 160 Mbyte/s External Bandwidth (40 MHz)
- High-Speed Interrupt Controller
  - Up to 240 External Interrupts
  - 31 Fully Programmable Priorities
  - Separate, Non-maskable Interrupt Pin
- Dual On-Chip 32-Bit Timers
  - Auto Reload Capability and One-Shot
  - CLKIN Prescaling,  $\div 1, 2, 4$  or 8
  - JTAG Support - IEEE 1149.1 Compliant

---

**Notice:** This document contains information on products in the sampling and initial production phases of development. The specifications are subject to change without notice. Verify with your local Intel sales office that you have the latest datasheet before finalizing a design.

---

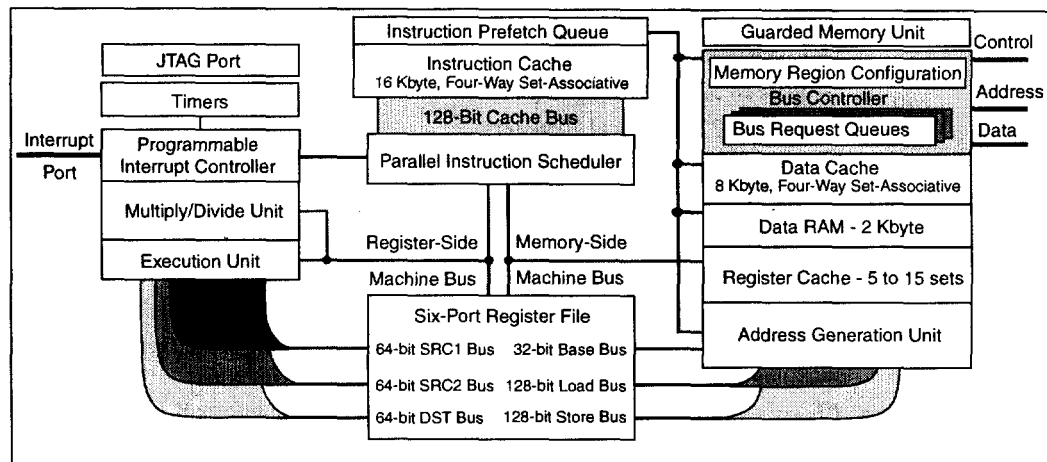
Order Number: 272495-007  
July, 1998

## 1.0 About This Document

This document describes the parametric performance of Intel's 80960Hx embedded superscalar microprocessors. Detailed descriptions for functional topics — other than parametric performance — are published in the *i960® Hx Microprocessor User's Guide (272484)*.

In this document, "80960Hx" and "i960 Hx processor" refer to the products described in Table 1. Throughout this document, information that is specific to each is clearly indicated.

**Figure 1. 80960Hx Block Diagram**



## 2.0 Intel's 80960Hx Processor

Intel's 80960Hx processor provides new performance levels while maintaining backward compatibility (pin<sup>1</sup> and software) with the i960 CA/CF processor. This newest member of the family of i960 32-bit, RISC-style, embedded processors allows customers to create scalable designs that meet multiple price and performance points. This is accomplished by providing processors that can run at the bus speed or faster using Intel's clock multiplying technology (Table 1). The 80960Hx core is capable of issuing 150 million instructions per second, using a sophisticated instruction scheduler that allows the processor to sustain a throughput of two instructions every core clock, with a peak performance of three instructions per clock. The 80960Hx-series comprises three processors, which differ in the ratio of core clock speed to external bus speed.

**Table 1. 80960Hx Product Description**

Product	Core	Voltage	Operating Frequency (bus/core)
80960HA	1x	3.3 V*	25/25, 33/33, 40/40
80960HD	2x	3.3 V*	16/32, 25/50, 33/66, 40/80
80960HT	3x	3.3 V*	20/60, 25/75

\*Processor inputs are 5 V tolerant.

- The 80960Hx is not "drop-in" compatible in an 80960Cx-based system. Customers can design systems that accept either 80960Hx or Cx processors.

In addition to expanded clock frequency options, the 80960Hx provides essential enhancements for an emerging class of high-performance embedded applications. Features include a larger instruction cache, data cache, and data RAM than any other 80960 processor to date. It also boasts a 32-bit demultiplexed and pipelined burst bus, fast interrupt mechanism, guarded memory unit, wait state generator, dual programmable timers, ONCE and IEEE 1149.1-compliant boundary scan test and debug support, and new instructions.

## 2.1 The i960<sup>®</sup> Processor Family

The i960 processor family is a 32-bit RISC architecture created by Intel to serve the needs of embedded applications. The embedded market includes applications as diverse as industrial automation, avionics, image processing, graphics and communications.

Because all members of the i960 processor family share a common core architecture, i960 applications are code-compatible. Each new processor in the family adds its own special set of functions to the core to satisfy the needs of a specific application or range of applications in the embedded market.

## 2.2 Key 80960Hx Features

### 2.2.1 Execution Architecture

Independent instruction paths inside the processor allow the execution of multiple, out-of-sequence instructions per clock. Register and resource scoreboarding interlocks maintain the logical integrity of sequential instructions that are being executed in parallel. To sustain execution of multiple instructions in each clock cycle, the processor decodes multiple instructions in parallel and simultaneously issues these instructions to parallel processing units. The various processing units are then able to independently access instruction operands in parallel from a common register set.

Local Register Cache integrated on-chip provides automatic register management on call/return instructions. Upon a call instruction, the processor allocates a set of local registers for the called procedure, then stores the registers for the previous procedure in the on-chip register cache. As additional procedures are called, the cache stores the associated registers such that the most recently called procedure is the first available by the next return (**ret**) instruction. The processor can store up to fifteen register sets, after which the oldest sets are stored (spilled) into external memory.

The 80960Hx supports the 80960 architecturally-defined branch prediction mechanism. This allows many branches to execute with no pipeline break. With the 80960Hx's efficient pipeline, a branch can take as few as zero clocks to execute. The maximum penalty for an incorrect prediction is two core clocks.

### 2.2.2 Pipelined, Burst Bus

A 32-bit high performance bus controller interfaces the 80960Hx core to the external memory and peripherals. The Bus Control Unit features a maximum transfer rate of 160 Mbytes per second (at a 40 MHz external bus clock frequency). A key advantage of this design is its versatility. The user can independently program the physical and logical attributes of system memory. Physical attributes include wait state profile, bus width, and parity. Logical attributes include cacheability and Big or Little Endian byte order. Internally programmable wait states and 16 separately configurable physical memory regions allow the processor to interface with a variety of memory

subsystems with minimum system complexity. To reduce the effect of wait states, the bus design is decoupled from the core. This lets the processor execute instructions while the bus performs memory accesses independently.

The Bus Controller's key features include:

- Demultiplexed, Burst Bus to support most efficient DRAM access modes
- Address Pipelining to reduce memory cost while maintaining performance
- 32-, 16- and 8-bit modes to facilitate I/O interfacing
- Full internal wait state generation to reduce system cost
- Little and Big Endian support
- Unaligned Access support implemented in hardware
- Three-deep request queue to decouple the bus from the core
- Independent physical and logical address space characteristics

### 2.2.3 On-Chip Caches and Data RAM

As shown in Figure 1, the 80960Hx provides generous on-chip cache and storage features to decouple CPU execution from the external bus. The processor includes a 16 Kbyte instruction cache, an 8 Kbyte data cache and 2 Kbytes of Data RAM. The caches are organized as 4-way set associative. Stores that hit the data cache are written through to memory. The data cache performs write allocation on cache misses. A fifteen-set stack frame cache allows the processor to rapidly allocate and deallocate local registers. All of the on-chip RAM sustains a 4-word (128-bit) access every clock cycle.

### 2.2.4 Priority Interrupt Controller

The interrupt unit provides the mechanism for the low latency and high throughput interrupt service essential for embedded applications. A priority interrupt controller provides full programmability of 240 interrupt sources with a typical interrupt task switch (latency) time of 17 core clocks. The controller supports 31 priority levels. Interrupts are prioritized and signaled within 10 core clocks of the request. If the interrupt has a higher priority than the processor priority, the context switch to the interrupt routine would typically complete in another 7 bus clocks.

External agents post interrupts via the 8-bit external interrupt port. The Interrupt unit also handles the two internal sources from the Timers. Interrupts can be level- or edge-triggered.

### 2.2.5 Guarded Memory Unit

The Guarded Memory Unit (GMU) provides memory protection without the address translation found in Memory Management Units. The GMU contains two memory protection schemes: one prevents illegal memory accesses, the other detects memory access violations. Both signal a fault to the processor. The programmable protection modes are: user read, write or execute; and supervisor read, write or execute.

## 2.2.6 Dual Programmable Timers

The processor provides two independent 32-bit timers, with four programmable clock rates. The user configures the timers via the Timer Unit registers. These registers are memory-mapped within the 80960Hx, addressable on 32-bit boundaries. The timers have a single-shot mode and auto-reload capabilities for continuous operation. Each timer has an independent interrupt request to the processor's interrupt controller.

## 2.2.7 Processor Self Test

When a system error is detected, the **FAIL** pin is asserted, a fail code message is driven onto the address bus, and the processor stops execution at the point of failure. The only way to resume normal operation is to perform a RESET operation. Because System Error generation can occur sometime after the bus confidence test and even after initialization during normal processor operation, the **FAIL** pin is HIGH (logic "1") before the detection of a System Error.

The processor uses only one read bus-transaction to signal the fail code message; the address of the bus transaction is the fail code itself. The fail code is of the form: **0xfeffffnn**; bits 6 to 0 contain a mask recording the possible failures. Bit 7, when set to 1, indicates that the mask contains failures from the internal Built-In Self-Test (BIST); when 0, the mask indicates other failures.

Ignore reserved bits 0 and 1. Also ignore bits 5 and 6 when bit 7 is clear (=0).

The mask is shown in Table 2 and Table 3.

**Table 2. Fail Codes For BIST (bit 7 = 1)**

Bit	When Set:
6	On-chip Data-RAM failure detected by BIST.
5	Internal Microcode ROM failure detected by BIST.
4	Instruction cache failure detected by BIST.
3	Data cache failure detected by BIST.
2	Local-register cache or processor core failure detected by BIST.
1	Reserved. Always zero.
0	Reserved. Always zero.

**Table 3. Remaining Fail Codes (bit 7 = 0)**

Bit	When Set:
6	Reserved. Always one.
5	Reserved. Always one.
4	A data structure within the IMI is not aligned to a word boundary.
3	A System Error during normal operation has occurred.
2	The Bus Confidence test has failed.
1	Reserved. Always zero.
0	Reserved. Always zero.

## 2.3 Instruction Set Summary

Table 4 summarizes the 80960Hx instruction set by logical groupings.

**Table 4. 80960Hx Instruction Set**

Data Movement	Arithmetic	Logical	Bit / Bit Field / Byte
Load Store Move Load Address Conditional Select <sup>(2)</sup>	Add Subtract Multiply Divide Remainder Modulo Shift Extended Shift Extended Multiply Extended Divide Add with Carry Subtract with Carry Rotate Conditional Add <sup>(2)</sup> Conditional Subtract <sup>(2)</sup>	And Not And And Not Or Exclusive Or Not Or Or Not Nor Exclusive Nor Not Nand	Set Bit Clear Bit Not Bit Alter Bit Scan For Bit Span Over Bit Extract Modify Scan Byte for Equal Byte Swap <sup>(2)</sup>
Comparison	Branch	Call/Return	Fault
Compare Conditional Compare Compare and Increment Compare and Decrement Compare Byte <sup>(2)</sup> Compare Short <sup>(2)</sup> Test Condition Code Check Bit	Unconditional Branch Conditional Branch Compare and Branch	Call Call Extended Call System Return Branch and Link	Conditional Fault Synchronize Faults
Debug	Processor Mgmt	Atomic	Cache Control
Modify Trace Controls Mark Force Mark	Flush Local Registers Modify Arithmetic Controls Modify Process Controls Interrupt Enable/Disable <sup>(1,2)</sup> System Control <sup>(1)</sup>	Atomic Add Atomic Modify	Instruction Cache Control <sup>(1,2)</sup> Data Cache Control <sup>(1,2)</sup>

**NOTES:**

1. 80960Hx extensions to the 80960 core instruction set.
2. 80960Hx extensions to the 80960Cx instruction set.

### 3.0 Package Information

This section describes the pins, pinouts and thermal characteristics for the 80960Hx in the 168-pin ceramic Pin Grid Array (PGA) package, 208-pin PowerQuad2\* (PQ4). For complete package specifications and information, see the Intel *Packaging Handbook* (Order# 240800).

The 80960HA/HD/HT is offered with eight speeds and two package types (Table 5). Both the 168-pin ceramic Pin Grid Array (PGA) and the 208-pin PowerQuad2\* (PQ4) devices are specified for operation at  $V_{CC} = 3.3 \text{ V} \pm 0.15 \text{ V}$  over a case temperature range of 0° to 85°C.

**Table 5. 80960HA/HD/HT Package Types and Speeds**

Package/Name	Device	Core Speed (MHz)	Bus Speed (MHz)	Order #
168L PGA	80960HA	25		A80960HA25 S L2GX
		33		A80960HA33 S L2GY
		40		A80960HA40 S L2GZ
	80960HD	32	16	A80960HD32 S L2GG
		50	25	A80960HD50 S L2GH
		66	33	A80960HD66 S L2GJ
		80	40	A80960HD80 S L2GK
	80960HT	60	20	A80960HT60
		75	25	A80960HT75 S L2GP
	208L PQFP (also known as PQ4)	80960HA	25	
33			FC80960HA33 S L2GV	
40			FC80960HA40 S L2GW	
80960HD		32	16	FC80960HD32 S L2GL
		50	25	FC80960HD50 S L2GM
		66	33	FC80960HD66 S L2GN
		80	40	FC80960HD80 S L2LZ
80960HT		60	20	FC80960HT60 S L2G2
		75	25	FC80960HT75 S L2GT

### 3.1 Pin Descriptions

This section defines the 80960Hx pins. Table 6 presents the legend for interpreting the pin descriptions in Table 7. All pins float while the processor is in the ONCE mode, except TDO, which can be driven active according to normal JTAG specifications.

**Table 6. Pin Description Nomenclature**

Symbol	Description
<b>I</b>	Input only pin.
<b>O</b>	Output only pin.
<b>I/O</b>	Pin can be input or output.
-	Pin must be connected as indicated for proper device functionality.
<b>S(E)</b>	Synchronous edge sensitive input. This input must meet the setup and hold times relative to CLKIN to ensure proper operation of the processor.
<b>S(L)</b>	Synchronous level sensitive input. This input must meet the setup and hold times relative to CLKIN to ensure proper operation of the processor.
<b>A(E)</b>	Asynchronous edge-sensitive input.
<b>A(L)</b>	Asynchronous level-sensitive input.
<b>H(...)</b>	While the processor bus is in the HOLD state (HOLDA asserted), the pin: H(1) is driven to V <sub>CC</sub> H(0) is driven to V <sub>SS</sub> H(Z) floats H(Q) continues to be a valid output
<b>B(...)</b>	While the processor is in the bus backoff state (BOFF asserted), the pin: B(1) is driven to V <sub>CC</sub> B(0) is driven to V <sub>SS</sub> B(Z) floats B(Q) continues to be a valid output
<b>R(...)</b>	While the processor's RESET pin is asserted, the pin: R(1) is driven to V <sub>CC</sub> R(0) is driven to V <sub>SS</sub> R(Z) floats R(Q) continues to be a valid output



Table 7. 80960Hx Processor Family Pin Descriptions (Sheet 1 of 4)

Name	Type	Description
A31:2	O H(Z) B(Z) R(Z)	<b>ADDRESS BUS</b> carries the upper 30 bits of the physical address. A31 is the most significant address bit and A2 is the least significant. During a bus access, A31:2 identify all external addresses to word (4-byte) boundaries. The byte enable signals indicate the selected byte in each word. During burst accesses, A3 and A2 increment to indicate successive addresses.
D31:0	I/O S(L) H(Z) B(Z) R(Z)	<b>DATA BUS</b> carries 32, 16, or 8-bit data quantities depending on bus width configuration. The least significant bit of the data is carried on D0 and the most significant on D31. The lower 8 data lines (D7:0) are used when the bus is configured for 8-bit data. When configured for 16-bit data, D15:0 are used.
DP3:0	I/O S(L) H(Z) B(Z) R(Z)	<b>DATA PARITY</b> carries parity information for the data bus. Each parity bit is assigned a group of 8 data bus pins as follows: DP3 generates/checks parity for D31:24 DP2 generates/checks parity for D23:16 DP1 generates/checks parity for D15:8 DP0 generates/checks parity for D7:0 Parity information is generated for a processor write cycle and is checked for a processor read cycle. Parity checking and polarity are programmable. Parity generation/checking is only performed for the size of the data accessed.
PCHK	O H(Q) B(Q) R(1)	<b>PARITY CHECK</b> indicates the result of a parity check operation. An asserted PCHK indicates that the previous bus read access resulted in a parity check error.
BE3:0	O H(Z) B(Z) R(1)	<b>BYTE ENABLES</b> select which of the four bytes addressed by A31:2 are active during a bus access. Byte enable encoding is dependent on the bus width of the memory region accessed: 32-bit bus: BE3 enables D31:24 BE2 enables D23:16 BE1 enables D15:8 BE0 enables D7:0 16-bit bus: BE3 becomes Byte High Enable (enables D15:8) BE2 is not used (state is undefined) BE1 becomes Address Bit 1 (A1) BE0 becomes Byte Low Enable (enables D7:0) 8-bit bus: BE3 is not used (state is undefined) BE2 is not used (state is undefined) BE1 Address Bit 1 (A1) BE0 Address Bit 0 (A0)
W/R	O H(Z) B(Z) R(0)	<b>WRITE/READ</b> is low for read accesses and high for write accesses. W/R becomes valid during the address phase of a bus cycle and remains valid until the end of the cycle for non-pipelined accesses. For pipelined accesses, W/R changes state when the next address is presented. 0= Read 1= Write
D/C	O H(Z) B(Z) R(0)	<b>DATA/CODE</b> indicates that a bus access is a data access or an instruction access. D/C has the same timing as W/R. 0 = Code 1 = Data

Table 7. 80960Hx Processor Family Pin Descriptions (Sheet 2 of 4)

Name	Type	Description
<b>SUP</b>	O H(Z) B(Z) R(1)	<b>SUPERVISOR ACCESS</b> indicates whether the current bus access originates from a request issued while in supervisor mode or user mode. <b>SUP</b> can be used by the memory subsystem to isolate supervisor code and data structures from non-supervisor access. 0 = Supervisor Mode 1 = User Mode
<b>ADS</b>	O H(Z) B(Z) R(1)	<b>ADDRESS STROBE</b> indicates a valid address and the start of a new bus access. <b>ADS</b> is asserted for the first clock of a bus access.
<b>READY</b>	I S(L)	<b>READY</b> , when enabled for a memory region, is asserted by the memory subsystem to indicate the completion of a data transfer. <b>READY</b> is used to indicate that read data on the bus is valid, or that a write transfer has completed. <b>READY</b> works in conjunction with the internal wait state generator to accommodate various memory speeds. <b>READY</b> is sampled after any programmed wait states: <i>During each data cycle of a burst access</i> <i>During the data cycle of a non-burst access</i>
<b>BTERM</b>	I S(L)	<b>BURST TERMINATE</b> , when enabled for a memory region, is asserted by the memory subsystem to terminate a burst access in progress. When <b>BTERM</b> is asserted, the current burst access is terminated and another address cycle occurs.
<b>WAIT</b>	O H(Z) B(Z) R(1)	<b>WAIT</b> indicates the status of the internal wait-state generator. <b>WAIT</b> is asserted when the internal wait state generator generates $N_{WAD}$ , $N_{RAD}$ , $N_{WDD}$ and $N_{RDD}$ wait states. <b>WAIT</b> can be used to derive a write data strobe.
<b>BLAST</b>	O H(Z) B(Z) R(1)	<b>BURST LAST</b> indicates the last transfer in a bus access. <b>BLAST</b> is asserted in the last data transfer of burst and non-burst accesses after the internal wait-state generator reaches zero. <b>BLAST</b> remains active as long as wait states are inserted via the <b>READY</b> pin. <b>BLAST</b> becomes inactive after the final data transfer in a bus cycle.
<b>DT/R</b>	O H(Z) B(Z) R(0)	<b>DATA TRANSMIT/RECEIVE</b> indicates direction for data transceivers. <b>DT/R</b> is used with <b>DEN</b> to provide control for data transceivers connected to the data bus. <b>DT/R</b> is driven low to indicate the processor expects data (a read cycle). <b>DT/R</b> is driven high when the processor is "transmitting" data (a store cycle). <b>DT/R</b> only changes state when <b>DEN</b> is high. 0 = Data Receive 1 = Data Transmit
<b>DEN</b>	O H(Z) B(Z) R(1)	<b>DATA ENABLE</b> indicates data transfer cycles during a bus access. <b>DEN</b> is asserted at the start of the first data cycle in a bus access and de-asserted at the end of the last data cycle. <b>DEN</b> remains asserted for an entire bus request, even when that request spans several bus accesses. For example, a <i>ldq</i> instruction starting at an unaligned quad word boundary is one bus request spanning at least two bus accesses. <b>DEN</b> remains asserted throughout all the accesses (including <b>ADS</b> states) and de-asserts when the <i>ldq</i> instruction request is satisfied. <b>DEN</b> is used with <b>DT/R</b> to provide control for data transceivers connected to the data bus. <b>DEN</b> remains asserted for sequential reads from pipelined memory regions.
<b>LOCK</b>	O H(Z) B(Z) R(1)	<b>BUS LOCK</b> indicates that an atomic read-modify-write operation is in progress. <b>LOCK</b> may be used by the memory subsystem to prevent external agents from accessing memory that is currently involved in an atomic operation (e.g., a semaphore). <b>LOCK</b> is asserted in the first clock of an atomic operation and de-asserted when <b>BLAST</b> is deasserted in the last bus cycle.

Table 7. 80960Hx Processor Family Pin Descriptions (Sheet 3 of 4)

Name	Type	Description																				
<b>HOLD</b>	I S(L)	<b>HOLD REQUEST</b> signals that an external agent requests access to the processor's address, data, and control buses. When HOLD is asserted, the processor: Completes the current bus request. Asserts HOLDA and floats the address, data, and control buses. When HOLD is deasserted, the HOLDA pin is deasserted and the processor reasserts control of the address, data, and control pins.																				
<b>HOLDA</b>	O H(1) B(0) R(Q)	<b>HOLD ACKNOWLEDGE</b> indicates to an external master that the processor has relinquished control of the bus. The processor grants HOLD requests and enters the HOLDA state while the RESET pin is asserted. HOLDA is never granted while LOCK is asserted.																				
<b>BOFF</b>	I S(L)	<b>BUS BACKOFF</b> forces the processor to immediately relinquish control of the bus on the next clock cycle. When READY/BTERM is enabled and: When BOFF is asserted, the address, data, and control buses are floated on the next clock cycle and the current access is aborted. When BOFF is deasserted, the processor resumes by regenerating the aborted bus access. See Figure 16 on page 40 for BOFF timing requirements.																				
<b>BREQ</b>	O H(Q) B(Q) R(0)	<b>BUS REQUEST</b> indicates that a bus request is pending in the bus controller. BREQ does not indicate whether or not the processor is stalled. See BSTALL for processor stall status. BREQ can be used with BSTALL to indicate to an external bus arbiter the processor's bus ownership requirements.																				
<b>BSTALL</b>	O H(Q) B(Q) R(0)	<b>BUS STALL</b> indicates that the processor has stalled pending the result of a request in the bus controller. When BSTALL is asserted, the processor must regain bus ownership to continue processing (i.e., it can no longer execute strictly out of on-chip cache memory).																				
<b>CT3:0</b>	O H(Z) B(Z) R(Z)	<b>CYCLE TYPE</b> indicates the type of bus cycle currently being started or processor state. CT3:0 encoding follows: <table style="width: 100%; border: none;"> <thead> <tr> <th style="text-align: left;">Cycle Type</th> <th style="text-align: left;">ADSCT3:0</th> </tr> </thead> <tbody> <tr> <td>Program-initiated access using 8-bit bus</td> <td>00000</td> </tr> <tr> <td>Program-initiated access using 16-bit bus</td> <td>00001</td> </tr> <tr> <td>Program-initiated access using 32-bit bus</td> <td>00010</td> </tr> <tr> <td>Event-initiated access using 8-bit bus</td> <td>00100</td> </tr> <tr> <td>Event-initiated access using 16-bit bus</td> <td>00101</td> </tr> <tr> <td>Event-initiated access using 32-bit bus</td> <td>00110</td> </tr> <tr> <td>Reserved</td> <td>00X11</td> </tr> <tr> <td>Reserved for future products</td> <td>01XXX</td> </tr> <tr> <td>Reserved</td> <td>1XXXX</td> </tr> </tbody> </table>	Cycle Type	ADSCT3:0	Program-initiated access using 8-bit bus	00000	Program-initiated access using 16-bit bus	00001	Program-initiated access using 32-bit bus	00010	Event-initiated access using 8-bit bus	00100	Event-initiated access using 16-bit bus	00101	Event-initiated access using 32-bit bus	00110	Reserved	00X11	Reserved for future products	01XXX	Reserved	1XXXX
Cycle Type	ADSCT3:0																					
Program-initiated access using 8-bit bus	00000																					
Program-initiated access using 16-bit bus	00001																					
Program-initiated access using 32-bit bus	00010																					
Event-initiated access using 8-bit bus	00100																					
Event-initiated access using 16-bit bus	00101																					
Event-initiated access using 32-bit bus	00110																					
Reserved	00X11																					
Reserved for future products	01XXX																					
Reserved	1XXXX																					
<b>XINT7:0</b>	I A(E) A(L)	<b>EXTERNAL INTERRUPT</b> pins are used to request interrupt service. These pins can be configured in three modes: <i>Dedicated Mode:</i> Each pin is assigned a dedicated interrupt level. Dedicated inputs can be programmed to be level (low or high) or edge (rising or falling) sensitive. <i>Expanded Mode:</i> All eight pins act as a vectored interrupt source. The interrupt pins are level sensitive in this mode. <i>Mixed Mode:</i> The XINT7:5 pins act as dedicated sources and the XINT4:0 pins act as the five most significant bits of a vectored source. The least significant bits of the vectored source are set to "010" internally.																				
<b>NMI</b>	I A(E)	<b>NON-MASKABLE INTERRUPT</b> causes a non-maskable interrupt event to occur. NMI is the highest priority interrupt source. NMI is falling edge triggered.																				

Table 7. 80960Hx Processor Family Pin Descriptions (Sheet 4 of 4)

Name	Type	Description
CLKIN	I	<b>CLOCK INPUT</b> provides the time base for the 80960Hx. All internal circuitry is synchronized to CLKIN. All input and output timings are specified relative to CLKIN. For the 80960HD, the 2x internal clock is derived by multiplying the CLKIN frequency by 2. For the 80960HT, the 3x internal clock is derived by multiplying the CLKIN frequency by 3.
RESET	I A(L)	<b>RESET</b> forces the device into reset. <b>RESET</b> causes all external and internal signals to return to their reset state (if defined). The rising edge of <b>RESET</b> starts the processor boot sequence.
STEST	I S(L)	<b>SELF TEST</b> , when asserted during the rising edge of <b>RESET</b> , causes the processor to execute its built in self-test.
FAIL	O H(Q) B(Q) R(O)	<b>FAIL</b> indicates a failure of the processor's built-in self-test performed during initialization. <b>FAIL</b> is asserted immediately out of reset and toggles during self-test to indicate the status of individual tests. If self-test passes, <b>FAIL</b> is de-asserted and the processor branches to the user's initialization code. When self-test fails, the <b>FAIL</b> pin asserts and the processor ceases execution.
ONCE	I	<b>ON-CIRCUIT EMULATION</b> control: the processor samples this pin during reset. If it is asserted low at the end of reset, the processor enters <b>ONCE</b> mode. In <b>ONCE</b> mode, the processor stops all clocks and floats all output pins except the TDO pin. <b>ONCE</b> uses an internal pull-up resistor; see $R_{PU}$ definition in Table 21 "80960Hx DC Characteristics" on page 32. Pull this pin high when not in use.
TCK	I	<b>TEST CLOCK</b> provides the clocking function for IEEE 1149.1 Boundary Scan testing.
TDI	I	<b>TEST DATA INPUT</b> is the serial input pin for IEEE 1149.1 Boundary Scan testing. <b>TDI</b> uses an internal pull-up resistor; see $R_{PU}$ definition in Table 21 "80960Hx DC Characteristics" on page 32.
TDO	O	<b>TEST DATA OUTPUT</b> is the serial output pin for IEEE 1149.1 Boundary Scan testing. <b>ONCE</b> does not disable this pin.
TRST	I	<b>TEST RESET</b> asynchronously resets the Test Access Port (TAP) controller. <b>TRST</b> must be held low at least 10,000 clock cycles after power-up. One method is to provide <b>TRST</b> with a separate power-on-reset circuit. <b>TRST</b> includes an internal pull-up resistor; see $R_{PU}$ definition in Table 21 "80960Hx DC Characteristics" on page 32. Pull this pin low when not in use.
TMS	I	<b>TEST MODE SELECT</b> is sampled at the rising edge of TCK. TCK controls the sequence of TAP controller state changes for IEEE 1149.1 Boundary Scan testing. <b>TMS</b> uses an internal pull-up resistor; see $R_{PU}$ definition in Table 21 "80960Hx DC Characteristics" on page 32.
VCC5	I	<b>5 V REFERENCE VOLTAGE</b> input is the reference voltage for the 5 V-tolerant I/O buffers. Connect this signal to +5 V for use with inputs which exceed 3.3 V. When all inputs are from 3.3 V components, connect this signal to 3.3 V.
VCCPLL	I	<b>PLL VOLTAGE</b> is the +3.3 VDC analog input for the PLL.
VOLDET	O	<b>VOLTAGE DETECT</b> signal allows external system logic to distinguish between a 5 V 80960Cx processor and the 3.3 V 80960Hx processor. This signal is active low for a 3.3 V 80960Hx (it is high impedance for 5 V 80960Cx). This pin is available only on the PGA version. 0 = 80960Hx 1 = 80960Cx

## 3.2 80960Hx Mechanical Data

### 3.2.1 80960Hx PGA Pinout

Figure 2 depicts the complete 80960Hx PGA pinout as viewed from the top side of the component (i.e., pins facing down). Figure 3 shows the complete 80960Hx PGA pinout as viewed from the pin-side of the package (i.e., pins facing up). Table 9 lists the 80960Hx pin names with package location. See Section 4.3, "Recommended Connections" on page 30 for specifications and recommended connections.

**Figure 2. 80960Hx 168-Pin PGA Pinout — View from Top (Pins Facing Down)**

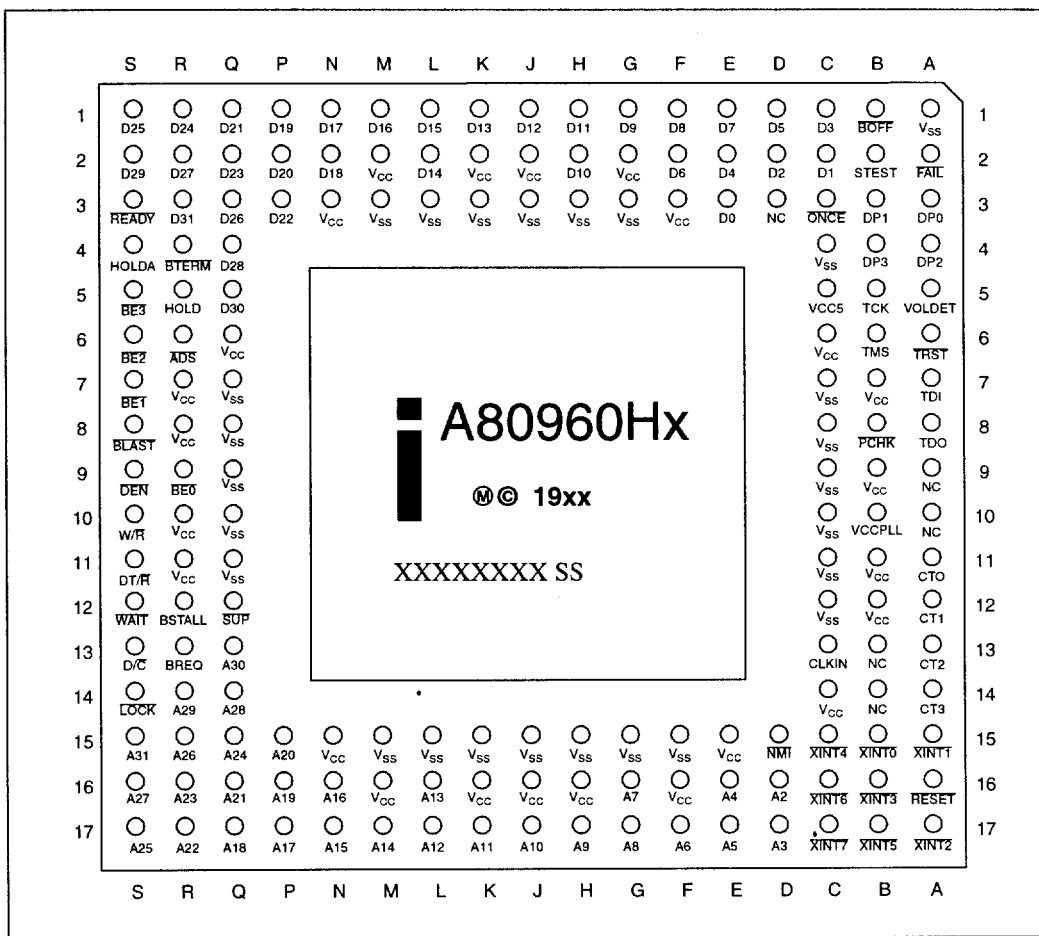
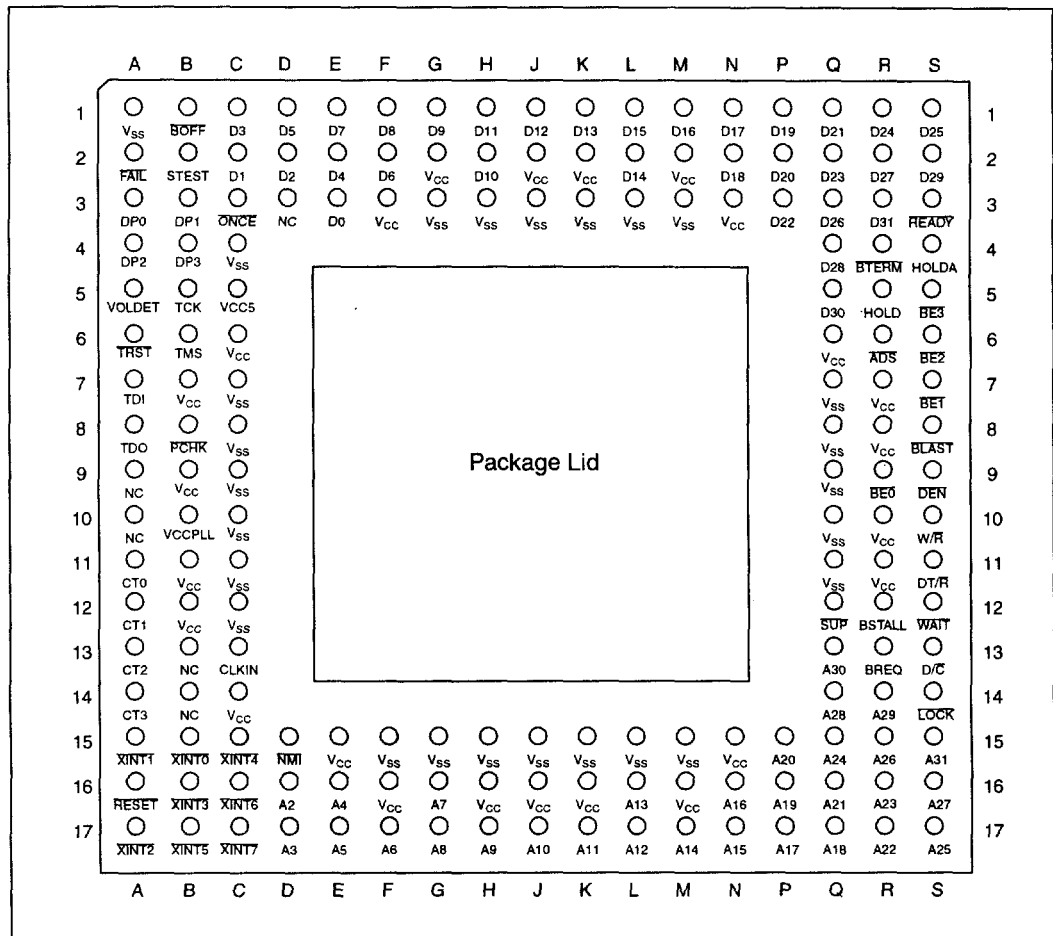


Figure 3. 80960Hx 168-Pin PGA Pinout — View from Bottom (Pins Facing Up)



**Table 8. 80960Hx 168-Pin PGA Pinout — Signal Name Order (Sheet 1 of 2)**

Signal Name	PGA Pin	Signal Name	PGA Pin	Signal Name	PGA Pin	Signal Name	PGA Pin
A2	D16	ADS	R6	D14	L2	LOCK	S14
A3	D17	BE0	R9	D15	L1	NC	A9
A4	E16	BET	S7	D16	M1	NC	A10
A5	E17	BE2	S6	D17	N1	NC	B13
A6	F17	BE3	S5	D18	N2	NC	B14
A7	G16	BLAST	S8	D19	P1	NC	D3
A8	G17	BOFF	B1	D20	P2	NMI	D15
A9	H17	BREQ	R13	D21	Q1	ONCE	C3
A10	J17	BSTALL	R12	D22	P3	PCHK	B8
A11	K17	BTERM	R4	D23	Q2	READY	S3
A12	L17	CLKIN	C13	D24	R1	RESET	A16
A13	L16	CT0	A11	D25	S1	STEST	B2
A14	M17	CT1	A12	D26	Q3	SUP	Q12
A15	N17	CT2	A13	D27	R2	TCK	B5
A16	N16	CT3	A14	D28	Q4	TDI	A7
A17	P17	D/C	S13	D29	S2	TDO	A8
A18	Q17	D0	E3	D30	Q5	TMS	B6
A19	P16	D1	C2	D31	R3	TRST	A6
A20	P15	D2	D2	DEN	S9	V <sub>CC</sub>	B7
A21	Q16	D3	C1	DP0	A3	V <sub>CC</sub>	B9
A22	R17	D4	E2	DP1	B3	V <sub>CC</sub>	B11
A23	R16	D5	D1	DP2	A4	V <sub>CC</sub>	B12
A24	Q15	D6	F2	DP3	B4	V <sub>CC</sub>	C6
A25	S17	D7	E1	DT/R	S11	V <sub>CC</sub>	C14
A26	R15	D8	F1	FAIL	A2	V <sub>CC</sub>	E15
A27	S16	D9	G1	—	—	V <sub>CC</sub>	F3
A28	Q14	D10	H2	—	—	V <sub>CC</sub>	F16
A29	R14	D11	H1	—	—	V <sub>CC</sub>	G2
A30	Q13	D12	J1	HOLD	R5	V <sub>CC</sub>	H16
A31	S15	D13	K1	HOLDA	S4	V <sub>CC</sub>	J2

Table 8. 80960Hx 168-Pin PGA Pinout — Signal Name Order (Sheet 2 of 2)

Signal Name	PGA Pin	Signal Name	PGA Pin	Signal Name	PGA Pin	Signal Name	PGA Pin
V <sub>CC</sub>	J16	VCCPLL	B10	V <sub>SS</sub>	H3	V <sub>SS</sub>	Q10
V <sub>CC</sub>	K2	VOLDET	A5	V <sub>SS</sub>	H15	V <sub>SS</sub>	Q11
V <sub>CC</sub>	K16	V <sub>SS</sub>	A1	V <sub>SS</sub>	J3	W/R	S10
V <sub>CC</sub>	M2	V <sub>SS</sub>	C4	V <sub>SS</sub>	J15	WAIT	S12
V <sub>CC</sub>	M16	V <sub>SS</sub>	C7	V <sub>SS</sub>	K3	XINT0	B15
V <sub>CC</sub>	N3	V <sub>SS</sub>	C8	V <sub>SS</sub>	K15	XINT1	A15
V <sub>CC</sub>	N15	V <sub>SS</sub>	C9	V <sub>SS</sub>	L3	XINT2	A17
V <sub>CC</sub>	Q6	V <sub>SS</sub>	C10	V <sub>SS</sub>	L15	XINT3	B16
V <sub>CC</sub>	R7	V <sub>SS</sub>	C11	V <sub>SS</sub>	M3	XINT4	C15
V <sub>CC</sub>	R8	V <sub>SS</sub>	C12	V <sub>SS</sub>	M15	XINT5	B17
V <sub>CC</sub>	R10	V <sub>SS</sub>	F15	V <sub>SS</sub>	Q7	XINT6	C16
V <sub>CC</sub>	R11	V <sub>SS</sub>	G3	V <sub>SS</sub>	Q8	XINT7	C17
VCC5	C5	V <sub>SS</sub>	G15	V <sub>SS</sub>	Q9	—	—



**Table 9. 80960Hx 168-Pin PGA Pinout — Pin Number Order (Sheet 1 of 2)**

PGA Pin	Signal Name	PGA Pin	Signal Name	PGA Pin	Signal Name	PGA Pin	Signal Name
A1	V <sub>SS</sub>	B14	NC	E15	V <sub>CC</sub>	K15	V <sub>SS</sub>
A2	FAIL	B15	XINT0	E16	A4	K16	V <sub>CC</sub>
A3	DP0	B16	XINT3	E17	A5	K17	A11
A4	DP2	B17	XINT5	F1	D8	L1	D15
A5	VOLDET	C1	D3	F2	D6	L2	D14
A6	TRST	C2	D1	F3	V <sub>CC</sub>	L3	V <sub>SS</sub>
A7	TDI	C3	ONCE	F15	V <sub>SS</sub>	L15	V <sub>SS</sub>
A8	TDO	C4	V <sub>SS</sub>	F16	V <sub>CC</sub>	L16	A13
A9	NC	C5	VCC5	F17	A6	L17	A12
A10	NC	C6	V <sub>CC</sub>	G1	D9	M1	D16
A11	CT0	C7	V <sub>SS</sub>	G2	V <sub>CC</sub>	M2	V <sub>CC</sub>
A12	CT1	C8	V <sub>SS</sub>	G3	V <sub>SS</sub>	M3	V <sub>SS</sub>
A13	CT2	C9	V <sub>SS</sub>	G15	V <sub>SS</sub>	M15	V <sub>SS</sub>
A14	CT3	C10	V <sub>SS</sub>	G16	A7	M16	V <sub>CC</sub>
A15	XINT1	C11	V <sub>SS</sub>	G17	A8	M17	A14
A16	RESET	C12	V <sub>SS</sub>	H1	D11	N1	D17
A17	XINT2	C13	CLKIN	H2	D10	N2	D18
B1	BOFF	C14	V <sub>CC</sub>	H3	V <sub>SS</sub>	N3	V <sub>CC</sub>
B2	STEST	C15	XINT4	H15	V <sub>SS</sub>	N15	V <sub>CC</sub>
B3	DP1	C16	XINT6	H16	V <sub>CC</sub>	N16	A16
B4	DP3	C17	XINT7	H17	A9	N17	A15
B5	TCK	D1	D5	J1	D12	P1	D19
B6	TMS	D2	D2	J2	V <sub>CC</sub>	P2	D20
B7	V <sub>CC</sub>	D3	NC	J3	V <sub>SS</sub>	P3	D22
B8	PCHK	D15	NMI	J15	V <sub>SS</sub>	P15	A20
B9	V <sub>CC</sub>	D16	A2	J16	V <sub>CC</sub>	P16	A19
B10	VCCPLL	D17	A3	J17	A10	P17	A17
B11	V <sub>CC</sub>	E1	D7	K1	D13	Q1	D21
B12	V <sub>CC</sub>	E2	D4	K2	V <sub>CC</sub>	Q2	D23
B13	NC	E3	D0	K3	V <sub>SS</sub>	Q3	D26

Table 9. 80960Hx 168-Pin PGA Pinout — Pin Number Order (Sheet 2 of 2)

PGA Pin	Signal Name	PGA Pin	Signal Name	PGA Pin	Signal Name	PGA Pin	Signal Name
Q4	D28	Q16	A21	R11	V <sub>CC</sub>	S6	BE <sub>2</sub>
Q5	D30	Q17	A18	R12	BSTALL	S7	BE <sub>1</sub>
Q6	V <sub>CC</sub>	R1	D24	R13	BREQ	S8	BLAST
Q7	V <sub>SS</sub>	R2	D27	R14	A29	S9	DEN
Q8	V <sub>SS</sub>	R3	D31	R15	A26	S10	W/R
Q9	V <sub>SS</sub>	R4	BTERM	R16	A23	S11	DT/R
Q10	V <sub>SS</sub>	R5	HOLD	R17	A22	S12	WAIT
Q11	V <sub>SS</sub>	R6	ADS	S1	D25	S13	D/C
Q12	SUP	R7	V <sub>CC</sub>	S2	D29	S14	LOCK
Q13	A30	R8	V <sub>CC</sub>	S3	READY	S15	A31
Q14	A28	R9	BE <sub>0</sub>	S4	HOLDA	S16	A27
Q15	A24	R10	V <sub>CC</sub>	S5	BE <sub>3</sub>	S17	A25

3.2.2 80960Hx PQ4 Pinout

Figure 4. 80960Hx 208-Pin PQ4 Pinout

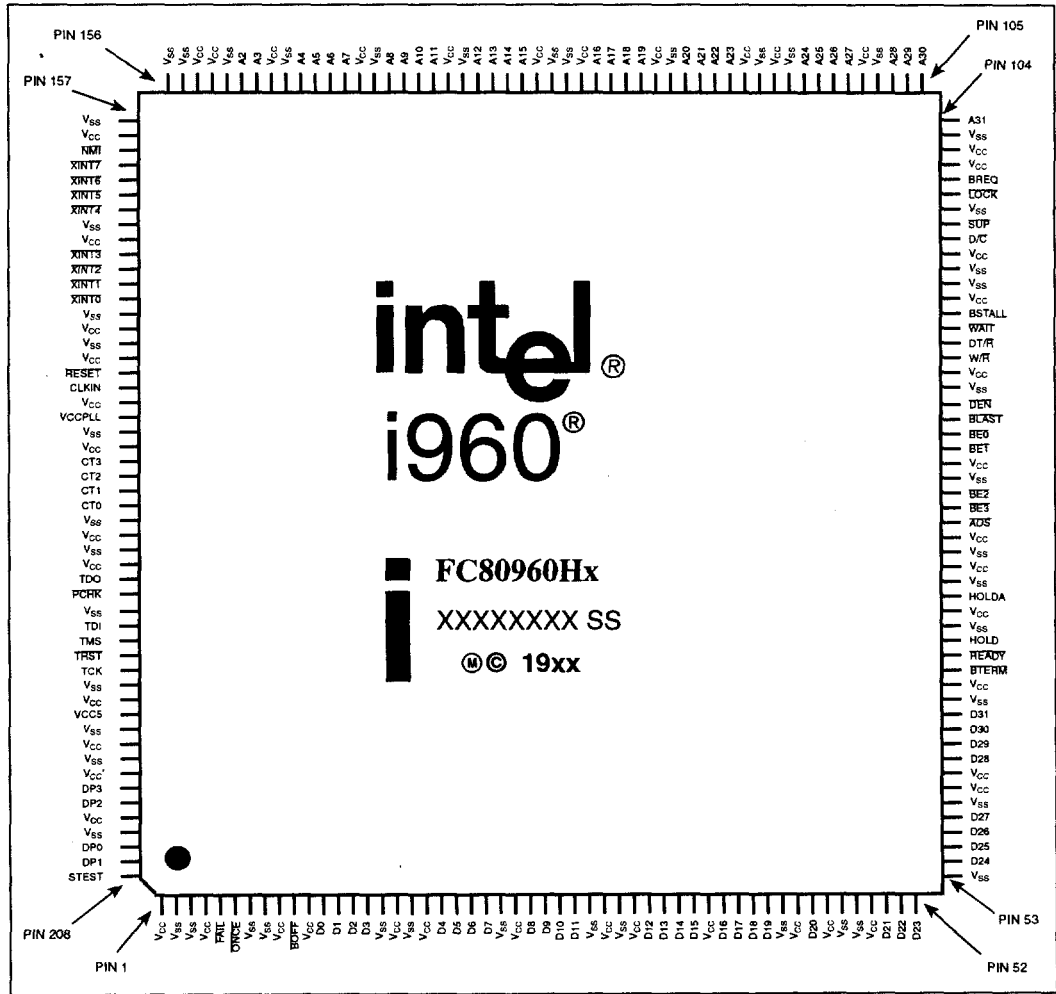


Table 10. 80960Hx PQ4 Pinout — Signal Name Order (Sheet 1 of 2)

Signal Name	PQ4 Pin	Signal Name	PQ4 Pin	Signal Name	PQ4 Pin	Signal Name	PQ4 Pin
A2	151	BE0	83	D16	39	PCHK	189
A3	150	BE1	82	D17	40	READY	68
A4	147	BE2	79	D18	41	RESET	174
A5	146	BE3	78	D19	42	STEST	208
A6	145	BLAST	84	D20	45	SUP	97
A7	144	BOFF	10	D21	50	TCK	194
A8	141	BREQ	100	D22	51	TDI	191
A9	140	BSTALL	91	D23	52	TDO	188
A10	139	BTERM	67	D24	54	TMS	192
A11	138	CLKIN	175	D25	55	TRST	193
A12	135	CT0	183	D26	56	V <sub>CC</sub>	1
A13	134	CT1	182	D27	57	V <sub>CC</sub>	4
A14	133	CT2	181	D28	61	V <sub>CC</sub>	9
A15	132	CT3	180	D29	62	V <sub>CC</sub>	11
A16	127	D/C	96	D30	63	V <sub>CC</sub>	17
A17	126	D0	12	D31	64	V <sub>CC</sub>	19
A18	125	D1	13	DEN	85	V <sub>CC</sub>	25
A19	124	D2	14	DP0	206	V <sub>CC</sub>	31
A20	121	D3	15	DP1	207	V <sub>CC</sub>	33
A21	120	D4	20	DP2	203	V <sub>CC</sub>	38
A22	119	D5	21	DP3	202	V <sub>CC</sub>	44
A23	118	D6	22	DT/R	89	V <sub>CC</sub>	46
A24	113	D7	23	FAIL	5	V <sub>CC</sub>	49
A25	112	D8	26	—	—	V <sub>CC</sub>	59
A26	111	D9	27	—	—	V <sub>CC</sub>	60
A27	110	D10	28	—	—	V <sub>CC</sub>	66
A28	107	D11	29	HOLD	69	V <sub>CC</sub>	71
A29	106	D12	34	HOLDA	72	V <sub>CC</sub>	74
A30	105	D13	35	LOCK	99	V <sub>CC</sub>	76
A31	104	D14	36	NMI	159	V <sub>CC</sub>	81
ADS	77	D15	37	ONCE	6	V <sub>CC</sub>	87

**Table 10. 80960Hx PQ4 Pinout — Signal Name Order (Sheet 2 of 2)**

Signal Name	PQ4 Pin	Signal Name	PQ4 Pin	Signal Name	PQ4 Pin	Signal Name	PQ4 Pin
V <sub>CC</sub>	92	V <sub>CC</sub>	187	V <sub>SS</sub>	70	V <sub>SS</sub>	164
V <sub>CC</sub>	95	V <sub>CC</sub>	196	V <sub>SS</sub>	73	V <sub>SS</sub>	170
V <sub>CC</sub>	101	V <sub>CC</sub>	199	V <sub>SS</sub>	75	V <sub>SS</sub>	172
V <sub>CC</sub>	102	V <sub>CC</sub>	201	V <sub>SS</sub>	80	V <sub>SS</sub>	178
V <sub>CC</sub>	109	V <sub>CC</sub>	204	V <sub>SS</sub>	86	V <sub>SS</sub>	184
V <sub>CC</sub>	115	V <sub>CC5</sub>	197	V <sub>SS</sub>	93	V <sub>SS</sub>	186
V <sub>CC</sub>	117	V <sub>CCPLL</sub>	177	V <sub>SS</sub>	94	V <sub>SS</sub>	190
V <sub>CC</sub>	123	V <sub>SS</sub>	2	V <sub>SS</sub>	98	V <sub>SS</sub>	195
V <sub>CC</sub>	128	V <sub>SS</sub>	3	V <sub>SS</sub>	103	V <sub>SS</sub>	198
V <sub>CC</sub>	131	V <sub>SS</sub>	7	V <sub>SS</sub>	108	V <sub>SS</sub>	200
V <sub>CC</sub>	137	V <sub>SS</sub>	8	V <sub>SS</sub>	114	V <sub>SS</sub>	205
V <sub>CC</sub>	143	V <sub>SS</sub>	16	V <sub>SS</sub>	116	W/R	88
V <sub>CC</sub>	149	V <sub>SS</sub>	18	V <sub>SS</sub>	122	WAIT	90
V <sub>CC</sub>	153	V <sub>SS</sub>	24	V <sub>SS</sub>	129	XINT0	169
V <sub>CC</sub>	154	V <sub>SS</sub>	30	V <sub>SS</sub>	130	XINT1	168
V <sub>CC</sub>	158	V <sub>SS</sub>	32	V <sub>SS</sub>	136	XINT2	167
V <sub>CC</sub>	165	V <sub>SS</sub>	43	V <sub>SS</sub>	142	XINT3	166
V <sub>CC</sub>	171	V <sub>SS</sub>	47	V <sub>SS</sub>	148	XINT4	163
V <sub>CC</sub>	173	V <sub>SS</sub>	48	V <sub>SS</sub>	152	XINT5	162
V <sub>CC</sub>	176	V <sub>SS</sub>	53	V <sub>SS</sub>	155	XINT6	161
V <sub>CC</sub>	179	V <sub>SS</sub>	58	V <sub>SS</sub>	156	XINT7	160
V <sub>CC</sub>	185	V <sub>SS</sub>	65	V <sub>SS</sub>	157	—	—

Table 11. 80960Hx PQ4 Pinout — Pin Number Order (Sheet 1 of 2)

PQ4 Pin	Signal Name	PQ4 Pin	Signal Name	PQ4 Pin	Signal Name	PQ4 Pin	Signal Name
1	V <sub>CC</sub>	31	V <sub>CC</sub>	61	D28	91	BSTALL
2	V <sub>SS</sub>	32	V <sub>SS</sub>	62	D29	92	V <sub>CC</sub>
3	V <sub>SS</sub>	33	V <sub>CC</sub>	63	D30	93	V <sub>SS</sub>
4	V <sub>CC</sub>	34	D12	64	D31	94	V <sub>SS</sub>
5	FATL	35	D13	65	V <sub>SS</sub>	95	V <sub>CC</sub>
6	ONCE	36	D14	66	V <sub>CC</sub>	96	D/C
7	V <sub>SS</sub>	37	D15	67	BTERM	97	SUP
8	V <sub>SS</sub>	38	V <sub>CC</sub>	68	READY	98	V <sub>SS</sub>
9	V <sub>CC</sub>	39	D16	69	HOLD	99	LOCK
10	BOFF	40	D17	70	V <sub>SS</sub>	100	BREQ
11	V <sub>CC</sub>	41	D18	71	V <sub>CC</sub>	101	V <sub>CC</sub>
12	D0	42	D19	72	HOLDA	102	V <sub>CC</sub>
13	D1	43	V <sub>SS</sub>	73	V <sub>SS</sub>	103	V <sub>SS</sub>
14	D2	44	V <sub>CC</sub>	74	V <sub>CC</sub>	104	A31
15	D3	45	D20	75	V <sub>SS</sub>	105	A30
16	V <sub>SS</sub>	46	V <sub>CC</sub>	76	V <sub>CC</sub>	106	A29
17	V <sub>CC</sub>	47	V <sub>SS</sub>	77	ADS	107	A28
18	V <sub>SS</sub>	48	V <sub>SS</sub>	78	BE3	108	V <sub>SS</sub>
19	V <sub>CC</sub>	49	V <sub>CC</sub>	79	BE2	109	V <sub>CC</sub>
20	D4	50	D21	80	V <sub>SS</sub>	110	A27
21	D5	51	D22	81	V <sub>CC</sub>	111	A26
22	D6	52	D23	82	BET	112	A25
23	D7	53	V <sub>SS</sub>	83	BE0	113	A24
24	V <sub>SS</sub>	54	D24	84	BLAST	114	V <sub>SS</sub>
25	V <sub>CC</sub>	55	D25	85	DEN	115	V <sub>CC</sub>
26	D8	56	D26	86	V <sub>SS</sub>	116	V <sub>SS</sub>
27	D9	57	D27	87	V <sub>CC</sub>	117	V <sub>CC</sub>
28	D10	58	V <sub>SS</sub>	88	W/R	118	A23
29	D11	59	V <sub>CC</sub>	89	DT/R	119	A22
30	V <sub>SS</sub>	60	V <sub>CC</sub>	90	WAIT	120	A21

Table 11. 80960Hx PQ4 Pinout — Pin Number Order (Sheet 2 of 2)

PQ4 Pin	Signal Name	PQ4 Pin	Signal Name	PQ4 Pin	Signal Name	PQ4 Pin	Signal Name
121	A20	143	V <sub>CC</sub>	165	V <sub>CC</sub>	187	V <sub>CC</sub>
122	V <sub>SS</sub>	144	A7	166	XINT3	188	TDO
123	V <sub>CC</sub>	145	A6	167	XINT2	189	PCHK
124	A19	146	A5	168	XINT1	190	V <sub>SS</sub>
125	A18	147	A4	169	XINT0	191	TDI
126	A17	148	V <sub>SS</sub>	170	V <sub>SS</sub>	192	TMS
127	A16	149	V <sub>CC</sub>	171	V <sub>CC</sub>	193	TRST
128	V <sub>CC</sub>	150	A3	172	V <sub>SS</sub>	194	TCK
129	V <sub>SS</sub>	151	A2	173	V <sub>CC</sub>	195	V <sub>SS</sub>
130	V <sub>SS</sub>	152	V <sub>SS</sub>	174	RESET	196	V <sub>CC</sub>
131	V <sub>CC</sub>	153	V <sub>CC</sub>	175	CLKIN	197	VCC5
132	A15	154	V <sub>CC</sub>	176	V <sub>CC</sub>	198	V <sub>SS</sub>
133	A14	155	V <sub>SS</sub>	177	VCCPLL	199	V <sub>CC</sub>
134	A13	156	V <sub>SS</sub>	178	V <sub>SS</sub>	200	V <sub>SS</sub>
135	A12	157	V <sub>SS</sub>	179	V <sub>CC</sub>	201	V <sub>CC</sub>
136	V <sub>SS</sub>	158	V <sub>CC</sub>	180	CT3	202	DP3
137	V <sub>CC</sub>	159	NMI	181	CT2	203	DP2
138	A11	160	XINT7	182	CT1	204	V <sub>CC</sub>
139	A10	161	XINT6	183	CT0	205	V <sub>SS</sub>
140	A9	162	XINT5	184	V <sub>SS</sub>	206	DP0
141	A8	163	XINT4	185	V <sub>CC</sub>	207	DP1
142	V <sub>SS</sub>	164	V <sub>SS</sub>	186	V <sub>SS</sub>	208	STEST

### 3.3 Package Thermal Specifications

The 80960Hx is specified for operation when  $T_C$  (case temperature) is within the range of  $0^{\circ}\text{C}$ – $85^{\circ}\text{C}$ .  $T_C$  may be measured in any environment to determine whether the 80960Hx is within the specified operating range. Measure the case temperature at the center of the top surface, opposite the pins. Refer to Figure 5.

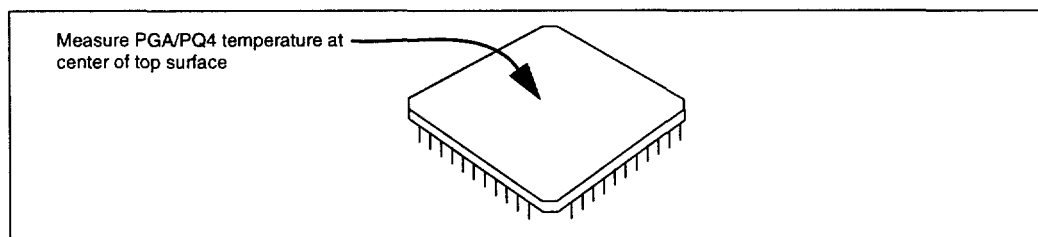
$T_A$  (ambient temperature) is calculated from  $\theta_{CA}$  (thermal resistance from case to ambient) using the equation:

$$T_A = T_C - P \cdot \theta_{CA}$$

Table 12 shows the maximum  $T_A$  allowable (without exceeding  $T_C$ ) at various airflows and operating frequencies ( $f_{CLKIN}$ ).

Note that  $T_A$  is greatly improved by attaching fins or a heatsink to the package.  $P$  (maximum power consumption) is calculated by using the typical  $I_{CC}$  as tabulated in Section 4.6, "DC Specifications" on page 32 and  $V_{CC}$  of 3.3 V.

**Figure 5. Measuring 80960Hx PGA Case Temperature**





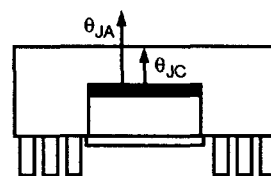
**Table 12. Maximum  $T_A$  at Various Airflows in °C (PGA Package Only)**

		$f_{CLKIN}$ (MHz)	Airflow-ft/min (m/sec)					
			0 (0)	200 (1.01)	400 (2.03)	600 (3.04)	800 (4.06)	1000 (5.07)
Core 1X Bus Clock	$T_A$ with Heatsink*	25	69	74	78	79	80	80
		33	63	70	75	77	79	79
		40	59	67	73	75	77	77
	$T_A$ without Heatsink	25	64	67	71	74	75	76
		33	56	62	67	70	72	74
		40	50	56	63	67	69	71
Core 2X Bus Clock	$T_A$ with Heatsink*	16	68	73	77	79	80	80
		25	58	66	73	75	77	77
		33	49	60	69	71	74	74
	$T_A$ without Heatsink	40	41	55	65	68	72	72
		16	62	66	71	73	75	76
		25	49	56	62	66	68	71
Core 3X Bus Clock	$T_A$ with Heatsink*	33	38	46	55	60	63	66
		40	27	38	48	55	58	62
		20	53	63	71	73	76	76
	$T_A$ without Heatsink	25	45	58	67	70	73	73
		20	43	51	58	63	66	68
		25	33	42	51	58	61	64

\*0.285" high unidirectional heatsink (Al alloy 6061, 50 mil fin width, 150 mil center-to-center fin spacing).

**Table 13. 80960Hx 168-Pin PGA Package Thermal Characteristics**

Thermal Resistance — °C/Watt							
Parameter	Airflow — ft./min (m/sec)						
	0 (0)	200 (1.01)	400 (2.03)	600 (3.07)	800 (4.06)	1000 (5.07)	
$\theta$ Junction-to-Case (Case measured as shown in Figure 5)	1.5	1.5	1.5	1.5	1.5	1.5	
$\theta$ Case-to-Ambient (No Heatsink)	17	14	11	9	8	7	
$\theta$ Case-to-Ambient (With Heatsink)*	13	9	6	5	4	4	


**NOTES:**

1. This table applies to 80960Hx PGA plugged into socket or soldered directly to board.
2.  $\theta_{JA} = \theta_{JC} + \theta_{CA}$

\*0.285" high unidirectional heatsink (Al alloy 6061, 50 mil fin width, 150 mil center-to-center fin spacing).

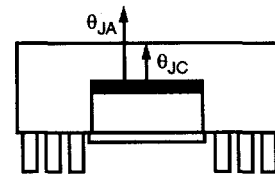
**Table 14. Maximum  $T_A$  at Various Airflows in °C (PQ4 Package Only)**

		Airflow-ft/min (m/sec)						
		$f_{CLKIN}$ (MHz)	0 (0)	200 (1.01)	400 (2.03)	600 (3.04)	800 (4.06)	1000 (5.07)
Core 1X Bus Clock	$T_A$ with Heatsink*	25 33 40	71 67 63	76 74 71	79 77 75	79 77 75	80 79 77	80 79 77
	$T_A$ without Heatsink	25 33 40	70 65 61	73 68 65	75 72 69	75 72 69	76 74 71	76 74 71
Core 2X Bus Clock	$T_A$ with Heatsink*	16 25 33 40	71 62 55 48	76 71 66 62	79 75 71 68	79 75 71 68	80 77 74 72	80 77 74 72
	$T_A$ without Heatsink	16 25 33 40	69 60 52 42	72 64 57 51	75 68 63 58	75 68 63 58	76 71 66 62	76 71 66 62
Core 3X Bus Clock	$T_A$ with Heatsink*	20 25	58 51	68 64	73 70	73 70	76 73	76 73
	$T_A$ without Heatsink	20 25	56 48	61 55	66 61	66 61	68 64	68 64

\*0.285" high unidirectional heatsink (Al alloy 6061, 50 mil fin width, 150 mil center-to-center fin spacing).

**Table 15. 80960Hx 208-Pin PQ4 Package Thermal Characteristics**

Thermal Resistance — °C/Watt						
Parameter	Airflow — ft./min (m/sec)					
	0 (0)	200 (1.01)	400 (2.03)	600 (3.07)	800 (4.06)	1000 (5.07)
$\theta$ Junction-to-Case (Case measured as shown in Figure 5)	1	1	1	1	1	1
$\theta$ Case-to-Ambient (No Heatsink)	12	10	8	8	7	7
$\theta$ Case-to-Ambient (With Heatsink)*	11	7	5	5	4	4



**NOTES:**

1. This table applies to 80960Hx PQ4 plugged into socket or soldered directly to board.
  2.  $\theta_{JA} = \theta_{JC} + \theta_{CA}$
- \*0.285" high unidirectional heatsink (Al alloy 6061, 50 mil fin width, 150 mil center-to-center fin spacing).

### 3.4 Heat Sink Adhesives

Intel recommends silicone-based adhesives to attach heat sinks to the PGA package. There is no particular recommendation concerning the PQ4 package.

### 3.5 PowerQuad4 Plastic Package

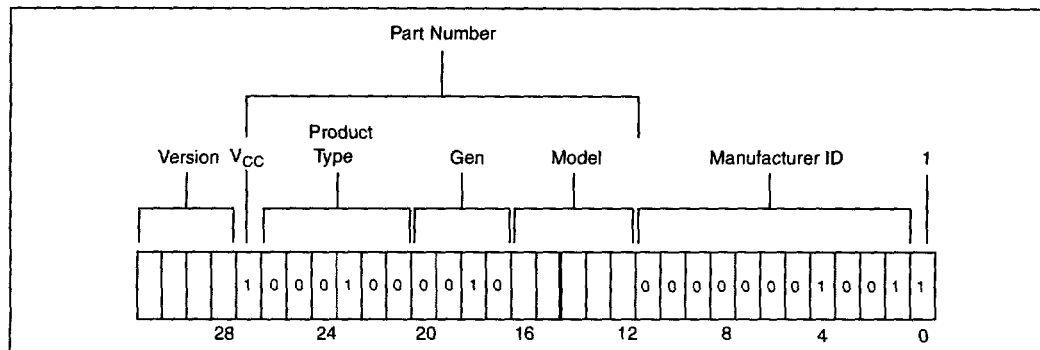
The 80960Hx family is available in an improved version of the common 208-lead SQFP plastic package called the PowerQuad4\* (PQ4). The PQ4 package dimensions and lead pitch are identical to the SQFP package and the former PQ2 package, so the PQ4 fits into the same board footprint. The advantage of the PQ4 package is the superior thermal conductivity that allows the plastic version of the 80960Hx to operate with the same 0-85°C temperature specifications as the more expensive ceramic PGA package.

The PQ4 package integrates a copper heat sink within the package to dissipate heat effectively. See Table 14 and Table 15.

### 3.6 Stepping Register Information

The memory-mapped register at FF008710H contains the 80960Hx Device ID. The ID is identical to the ID obtained from a JTAG Query. Figure 6 defines the current 80960Hx Device IDs. The value for device identification is compliant with the IEEE 1149.1 specification and Intel standards. Table 16 describes the fields of the device ID.

**Figure 6. 80960Hx Device Identification Register**



**Table 16. Fields of 80960Hx Device ID**

Field	Value	Definition
Version	See Table 18	Indicates major stepping changes.
V <sub>CC</sub>	1 = 3.3 V device	Indicates that a device is 3.3 V.
Product Type	00 0100 (Indicates i960 CPU)	Designates type of product.
Generation Type	0010 = H-series	Indicates the generation (or series) the product belongs to.
Model	See Table 17	Indicates member within a series and specific model information.
Manufacturer ID	000 0000 1001 (Indicates Intel)	Manufacturer ID assigned by IEEE.

**Table 17. 80960Hx Device ID Model Types**

Device	Version	V <sub>CC</sub>	Product	Gen.	Model	Manufacturer ID	'1'
80960HA	See Table 18	1	000100	0010	00000	00000001001	1
80960HD		1	000100	0010	00001	00000001001	1
80960HT		1	000100	0010	00010	00000001001	1

**Table 18. Device ID Version Numbers for Different Steppings**

Stepping	Version
A0	0000
A1	0001
A2	0001
B0, B2	0010

This data sheet applies to the B2 stepping.

## 3.7 Sources for Accessories

The following is a list of suggested sources for 80960Hx accessories. This is neither an endorsement nor a warranty of the performance of any of the listed products and/or companies.

### Sockets

- 3M Textool Test and Interconnection Products  
6801 River Place Blvd. MS 130-3N-29  
Austin, TX 78726-9000  
(800) 328-0411 FAX: (800) 932-9373
- Concept Mfg. Inc. (Decoupling Sockets)  
400 Walnut St. Suite 609  
Redwood City, CA 94063  
(415) 365-1162 FAX: (415) 365-1164

### Heatsinks/Fins

- Thermalloy, Inc.  
2021 West Valley View Lane  
Dallas, TX 75234-8993  
(972) 243-4321 FAX: (972) 241-4656
- Wakefield Engineering, Inc.  
60 Audubon Road  
Wakefield, MA 01880  
(617) 245-5900 FAX: (617) 246-0874
- Aavid Thermal Technologies, Inc.  
One Kool Path  
Laconia, NH 03247-0400  
(603) 523-3400

## 4.0 Electrical Specifications

### 4.1 Absolute Maximum Ratings

Parameter	Maximum Rating
Storage Temperature	-65 °C to +150 °C
Case Temperature Under Bias	-65oC to +110oC
Supply Voltage with respect to V <sub>SS</sub>	-0.5 V to + 4.6 V
Voltage on VCC5 with respect to V <sub>SS</sub>	-0.5 V to + 6.5 V
Voltage on Other Pins with respect to V <sub>SS</sub>	-0.5 V to VCC5 + 0.5 V

**Notice:** This document contains information on products in the sampling and initial production phases of development. It is valid for the devices indicated in the revision history. The specifications within this data sheet are subject to change without notice. Verify with your local Intel sales office that you have the latest data sheet before finalizing a design.

**Warning:** *Stressing the device beyond the “Absolute Maximum Ratings” may cause permanent damage. These are stress ratings only. Operation beyond the “Operating Conditions” is not recommended and extended exposure beyond the “Operating Conditions” may affect device reliability.*

### 4.2 Operating Conditions

Table 19. Operating Conditions

Symbol	Parameter	Min	Max	Units
V <sub>CC</sub>	Supply Voltage	3.15	3.45	V
VCC5	Input Protection Bias	3.15	5.5	V
f <sub>CLKIN 1xcore</sub>	Input Clock Frequency - 1x Core (80960HA)	16	40	MHz
f <sub>CLKIN 2xcore</sub>	Input Clock Frequency - 2x Core (80960HD)	16	40	MHz
f <sub>CLKIN 3xcore</sub>	Input Clock Frequency - 3x Core (80960HT)	16	25	MHz
T <sub>C</sub>	Case Temp Under Bias (PGA and PQ4 Packages)	0	85	°C

### 4.3 Recommended Connections

Power and ground connections must be made to multiple  $V_{CC}$  and  $V_{SS}$  (GND) pins. Every 80960Hx-based circuit board should include power ( $V_{CC}$ ) and ground ( $V_{SS}$ ) planes for power distribution. Every  $V_{CC}$  pin must be connected to the power plane; every  $V_{SS}$  pin must be connected to the ground plane. Pins identified as “NC” —no connect pins—**must not** be connected in the system.

Liberal decoupling capacitance should be placed near the 80960Hx. The processor can cause transient power surges when its output buffers transition, particularly when connected to large capacitive loads.

Low inductance capacitors and interconnects are recommended for best high-frequency electrical performance. Inductance can be reduced by shortening the board traces between the processor and decoupling capacitors as much as possible. Capacitors specifically designed for PGA packages offer the lowest possible inductance.

For reliable operation, always connect unused inputs to an appropriate signal level. In particular, any unused interrupt ( $XINT7:0$ , NMI) input should be connected to  $V_{CC}$  through a pull-up resistor, as should  $BTERM$  if not used. Pull-up resistors should be in the range of 20 K $\Omega$  for each pin tied high. If  $READY$  or  $HOLD$  are not used, the unused input should be connected to ground. **N.C. pins must always remain unconnected.**

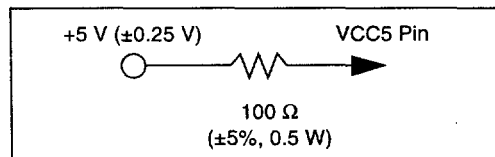
### 4.4 VCC5 Pin Requirements ( $V_{DIFF}$ )

In mixed-voltage systems that drive 80960Hx processor inputs in excess of 3.3 V, the VCC5 pin must be connected to the system’s 5 V supply. To limit current flow into the VCC5 pin, there is a limit to the voltage differential between the VCC5 pin and the other  $V_{CC}$  pins. The voltage differential between the 80960Hx VCC5 pin and its 3.3 V  $V_{CC}$  pins should never exceed 2.25 V. This limit applies to power-up, power-down, and steady-state operation. Table 20 outlines this requirement.

Meeting this requirement ensures proper operation and guarantees that the current draw into the VCC5 pin does not exceed the  $I_{CC5}$  specification.

If the voltage difference requirements cannot be met due to system design limitations, an alternate solution may be employed. As shown in Figure 7, a minimum of 100  $\Omega$  series resistor may be used to limit the current into the VCC5 pin. This resistor ensures that current drawn by the VCC5 pin does not exceed the maximum rating for this pin.

Figure 7. VCC5 Current-Limiting Resistor



This resistor is not necessary in systems that can guarantee the  $V_{DIFF}$  specification.

In 3.3 V-only systems and systems that drive 80960Hx pins from 3.3 V logic, connect the VCC5 pin directly to the 3.3 V  $V_{CC}$  plane.

Table 20.  $V_{DIFF}$  Specification for Dual Power Supply Requirements (3.3 V, 5 V)

Sym	Parameter	Min	Max	Units	Notes
$V_{DIFF}$	VCC5- $V_{CC}$ Difference		2.25	V	VCC5 input should not exceed $V_{CC}$ by more than 2.25 V during power-up and power-down, or during steady-state operation.

## 4.5 VCCPLL Pin Requirements

If the voltage on the VCCPLL power supply pin exceeds the  $V_{CC}$  pin voltage by 0.5 V at any time, including the power up and power down sequences, excessive currents can permanently damage on-chip electrostatic discharge (ESD) protection diodes. The damage can accumulate over multiple episodes.

Pragmatically, this problem only occurs when the VCCPLL and  $V_{CC}$  pins are driven by separate power supplies or voltage regulators. Applications that use one power supply for VCCPLL and  $V_{CC}$  are not typically at risk. Verify that your application does not allow the VCCPLL voltage to exceed  $V_{CC}$  by 0.5 V.

The VCCPL low-pass filter recommended in the Developer's Manual does not promote this problem.



## 4.6 DC Specifications

**Table 21. 80960Hx DC Characteristics (Sheet 1 of 2)**

Per the conditions described in Section 4.3, "Recommended Connections" on page 30.

Symbol	Parameter	Min	Typ	Max	Units	Notes
V <sub>IL</sub>	Input Low Voltage	-0.3		+0.8	V	
V <sub>IH</sub>	Input High Voltage	2.0		V <sub>CC5</sub> + 0.3	V	
V <sub>OL</sub>	Output Low Voltage All outputs except F <sub>ATL</sub>			0.4 0.2	V	I <sub>OL</sub> = 3 mA I <sub>OL</sub> = 100 μA
V <sub>OL</sub>	Output Low Voltage F <sub>ATL</sub> pin			0.4	V	I <sub>OL</sub> = 5 mA
V <sub>OH</sub>	Output High Voltage	2.4 V <sub>CC</sub> - 0.2			V V	I <sub>OH</sub> = -3 mA I <sub>OH</sub> = -100 μA
I <sub>LI</sub>	Input Leakage Current Non-Test Inputs TDI, TMS, TRST and ONCE	-1		1 -110	μA μA	0 ≤ V <sub>IN</sub> ≤ V <sub>CC</sub> V <sub>IN</sub> = 0 V
I <sub>LO</sub>	Output Leakage Current Non-Test Outputs TDO pin			1 5	μA μA	0.45 ≤ V <sub>OUT</sub> ≤ V <sub>CC</sub> 0.45 ≤ V <sub>OUT</sub> ≤ V <sub>CC</sub>
I <sub>CC</sub> Active (Power Supply)	80960HA 25 33 40 80960HD 32 50 66 80 80960HT 60 75			579 765 927 631 985 1300 1578 1165 1455	mA	(4,5)
I <sub>CC</sub> Active (Thermal)	80960HA 25 33 40 80960HD 32 50 66 80 80960HT 60 75		392 518 628 413 645 851 1034 752 938		mA	(4,6)
I <sub>CC</sub> Test (Reset Mode)	80960HA 25 33 40 80960HD 32 50 66 80 80960HT 60 75			330 436 528 382 595 785 955 702 878	mA	(7,8)
I <sub>CC</sub> Test (ONCE mode)				25	mA	(7)

**Table 21. 80960Hx DC Characteristics (Sheet 2 of 2)**

Per the conditions described in Section 4.3, "Recommended Connections" on page 30.

Symbol	Parameter	Min	Typ	Max	Units	Notes
$I_{CC5}$ Current on the VCC5 Pin	80960HA 80960HD 80960HT			200 200 200	$\mu$ A	(9)
$C_{IN}$	Input Capacitance for:  PQ4 PGA			12 12	pF pF	$F_C = 1$ MHz (10)
$C_{OUT}$	Output Capacitance of each output pin			12	pF	$F_C = 1$ MHz (3,10)
$C_{I/O}$	I/O Pin Capacitance			12	pF	$F_C = 1$ MHz (10)
$R_{PU}$	Internal Pull-Up Resistance for ONCE, TMS, TDI and TRST	30	65	100	k $\Omega$	

**NOTES:**

- $I_{CC}$  Maximum is measured at worst case frequency,  $V_{CC}$ , and temperature, with device operating and outputs loaded to the test conditions described in Section 4.7.1, "AC Test Conditions" on page 37.
- $I_{CC}$  Typical is not tested.
- Output Capacitance is the capacitive load of a floating output.
- Measured with device operating and outputs loaded to the test conditions in Figure 8 "AC Test Load" on page 37. Input signals rise to  $V_{CC}$  and fall to  $V_{SS}$ .
- $I_{CC}$  Active (Power Supply) value is provided for selecting your system's power supply. It is measured using one of the worst case instruction mixes with  $V_{CC} = 3.45$  V. This parameter is characterized but not tested.
- $I_{CC}$  Active (Thermal) value is provided for your system's thermal management. Typical  $I_{CC}$  is measured with  $V_{CC} = 3.3$  V and temperature = 25°C. This parameter is characterized but not tested.
- $I_{CC}$  Test (Power modes) refers to the  $I_{CC}$  values that are tested when the 80960HA/HD/HT is in Reset mode or ONCE mode with  $V_{CC} = 3.45$  V.
- Worst case is  $V_{CC} = 3.45$  V, 0°C.
- $I_{CC5}$  is tested at  $V_{CC} = 3.0$  V,  $V_{CC5} = 5.25$  V.
- Pin capacitance is characterized, but not tested.

## 4.7 AC Specifications

**Table 22. 80960Hx AC Characteristics (Sheet 1 of 2)**

Per conditions in Section 4.2, "Operating Conditions" on page 29 and Section 4.7.1, "AC Test Conditions" on page 37.

Symbol	Parameter	Min	Max	Units	Notes	
<b>Input Clock (1,7)</b>						
T <sub>F</sub>	CLKIN Frequency	80960HA	16	40	MHz	
		80960HD	16	40	MHz	
		80960HT	16	25	MHz	
T	CLKIN Period	80960HA	25	62.5	ns	
		80960HD	25	62.5	ns	
		80960HT	40	62.5	ns	
T <sub>CS</sub>	CLKIN Period Stability	-250	+250	ps	(11)	
T <sub>CH</sub>	CLKIN High Time	8		ns	(11)	
T <sub>CL</sub>	CLKIN Low Time	80960HA	8		ns	(11)
		80960HD	8		ns	
		80960HT	8		ns	
T <sub>CR</sub>	CLKIN Rise Time	0	4	ns	(11)	
T <sub>CF</sub>	CLKIN Fall Time	0	4	ns	(11)	
<b>Synchronous Outputs (1,2,3,6)</b>						
T <sub>OV1</sub> , T <sub>OH1</sub>	Output Valid Delay and Output Hold for all outputs except DT/R, BLAST and BREQ for 3.3 V and 5 V inputs and I/Os.	1.5	9.5	ns		
T <sub>OV2</sub> , T <sub>OH2</sub>	Output Valid Delay and Output Hold for DT/R	80960HA	T/2 + 1.5	T/2 + 9.5	ns	
		80960HD	3T/4 + 1.5	3T/4 + 9.5	ns	
		80960HT	5T/6 + 1.5	5T/6 + 9.5	ns	
T <sub>OV3</sub> , T <sub>OH3</sub>	Output Valid Delay and Output Hold for BLAST	1.5	9	ns		
T <sub>OV4</sub> , T <sub>OH4</sub>	Output Valid Delay and Output Hold for BREQ	0.5	9	ns		
T <sub>OV5</sub> , T <sub>OH5</sub>	Output Valid Delay and Output Hold for A3:2	1.5	8.5			
T <sub>OF</sub>	Output Float for all outputs	1.5	9	ns	(11)	
<b>Synchronous Inputs (1,7,8,9)</b>						
T <sub>IS1</sub>	Input Setup for all inputs except READY, BTERM, HOLD, and BOFF	2.5		ns		
T <sub>IH1</sub>	Input Hold for all inputs except READY, BTERM, HOLD, and BOFF	2.5		ns		
T <sub>IS2</sub>	Input Setup for READY, BTERM, HOLD, and BOFF	6		ns		

**NOTE:** See Table 23 "AC Characteristics Notes" on page 36 for all notes related to AC specifications.

**Table 22. 80960Hx AC Characteristics (Sheet 2 of 2)**

Per conditions in Section 4.2, "Operating Conditions" on page 29 and Section 4.7.1, "AC Test Conditions" on page 37.

Symbol	Parameter	Min	Max	Units	Notes
$T_{IH2}$	Input Hold for <b>READY</b> , <b>BTERM</b> , <b>HOLD</b> , and <b>BOFF</b>	2.5		ns	
<b>Relative Output Timings (1,2,3,6,10)</b>					
$T_{AVSH1}$	A31:2 Valid to $\overline{ADS}$ Rising	$T - 5$	$T + 5$	ns	(10)
$T_{AVSH2}$	BE3:0, W/R, SUP, D/C Valid to $\overline{ADS}$ Rising	$T - 5$	$T + 5$	ns	(10)
$T_{AVEL1}$	A31:2 Valid to $\overline{DEN}$ Falling	$T - 5$	$T + 5$	ns	(10)
$T_{AVEL2}$	BE3:0, W/R, SUP Valid to $\overline{DEN}$ Falling	$T - 5$	$T + 5$	ns	(10)
$T_{NLQV}$	$\overline{WAIT}$ Falling to Output Data Valid	-5	5	ns	(10)
$T_{DVNH}$	Output Data Valid to $\overline{WAIT}$ Rising	$-5 + N \cdot T$	$5 + N \cdot T$	ns	(4,10)
$T_{NLNH}$	$\overline{WAIT}$ Falling to $\overline{WAIT}$ Rising	$-4 + N \cdot T$	$4 + N \cdot T$	ns	(4,10)
$T_{NHQX}$	Output Data Hold after $\overline{WAIT}$ Rising	$-5 + (N+1) \cdot T$	$5 + (N+1) \cdot T$	ns	(5,10)
$T_{EHTV}$	DT/R Hold after $\overline{DEN}$ High	$T/2 - 5$	Infinite	ns	(10)
$T_{TVEL}$	DT/R Valid to $\overline{DEN}$ Falling	80960HA 80960HD 80960HT	$T/2 - 4$ $T/4 - 4$ $T/6 - 4$	ns ns ns	(10)
<b>Relative Input Timings (1,7,10)</b>					
$T_{IS7}$	XINT7:0, NMI Input Setup	6		ns	(9)
$T_{IH7}$	XINT7:0, NMI Input Hold	2.5		ns	(9)
$T_{IS8}$	RESET Input Setup	3		ns	(8)
$T_{IH8}$	RESET Input Hold	$T/4 + 1$		ns	(8)

**NOTE:** See Table 23 "AC Characteristics Notes" on page 36 for all notes related to AC specifications.

**Table 23. AC Characteristics Notes**

<b>NOTES:</b>					
1. See Section 4.8, "AC Timing Waveforms" on page 38 for waveforms and definitions.					
2. See Figure 25 "Output Delay or Hold vs. Load Capacitance" on page 44 for capacitive derating information for output delays and hold times.					
3. See Figure 22 "Rise and Fall Time Derating at 85°C and Minimum V <sub>CC</sub> " on page 43 for capacitive derating information for rise and fall times.					
4. Where N is the number of N <sub>RAD</sub> , N <sub>RDD</sub> , N <sub>WAD</sub> or N <sub>WDD</sub> wait states that are programmed in the Bus Controller Region Table. <b>WAIT</b> never goes active when there are no wait states in an access.					
5. N = Number of wait states inserted with <b>READY</b> .					
6. These specifications are guaranteed by the processor.					
7. These specifications must be met by the system for proper operation of the processor.					
8. <b>RESET</b> is an asynchronous input that has no required setup and hold time for proper operation. However, to guarantee the device exits the reset mode synchronized to a particular clock edge, the rising edge of <b>RESET</b> must meet setup and hold times to the rising edge of the CLKIN.					
9. The interrupt pins are synchronized internally by the 80960Hx. They have no required setup or hold times for proper operation. These pins are sampled by the interrupt controller every clock and must be active for at least two consecutive CLKIN rising edges when asserting them asynchronously. To guarantee recognition at a particular clock edge, the setup and hold times shown must be met.					
10. Relative Output timings are not tested.					
11. Not tested.					
12. The processor minimizes changes to the bus signals when transitioning from a bus cycle to an idle bus for the following signals: A31:4, SUP, CT3:0, D/C, LOCK, W/R, BE3:0.					

**Table 24. 80960Hx Boundary Scan Test Signal Timings**

Symbol	Parameter	Min	Max	Units	Notes
T <sub>BSF</sub>	TCK Frequency	0	8	MHz	
T <sub>BSC</sub>	TCK Period	125	Infinite	ns	
T <sub>BSCH</sub>	TCK High Time	40		ns	Measured at 1.5 V (1)
T <sub>BSCL</sub>	TCK Low Time	40		ns	Measured at 1.5 V (1)
T <sub>BSCR</sub>	TCK Rise Time		8	ns	0.8 V to 2.0 V (1)
T <sub>BSCF</sub>	TCK Fall Time		8	ns	2.0 V to 0.8 V (1)
T <sub>BSIS1</sub>	Input Setup to TCK — TDI, TMS	8		ns	
T <sub>BSIH1</sub>	Input Hold from TCK — TDI, TMS	10		ns	
T <sub>BSOV1</sub>	TDO Valid Delay	3	30	ns	
T <sub>BSOF1</sub>	TDO Float Delay		36	ns	(1)
T <sub>BSOV2</sub>	All Outputs (Non-Test) Valid Delay	3	30	ns	Relative to TCK
T <sub>BSOF2</sub>	All Outputs (Non-Test) Float Delay		36	ns	Relative to TCK (1)
T <sub>BSIS2</sub>	Input Setup to TCK - All Inputs (Non-Test)	8		ns	
T <sub>BSIH2</sub>	Input Hold from TCK - All Inputs (Non-Test)	10		ns	

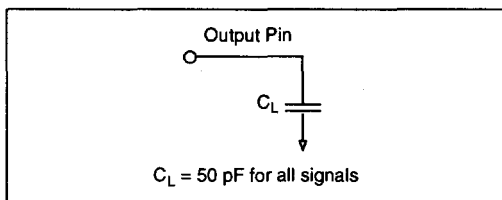
**NOTE:**

1. Not tested.

### 4.7.1 AC Test Conditions

AC values are derived using the 50 pF load shown in Figure 8. Figure 25 “Output Delay or Hold vs. Load Capacitance” on page 44, shows how timings vary with load capacitance. Input waveforms (except for CLKIN) are assumed to have a rise and fall time of  $\leq 2$  ns from 0.8 V to 2.0 V.

**Figure 8. AC Test Load**



## 4.8 AC Timing Waveforms

Figure 9. CLKIN Waveform

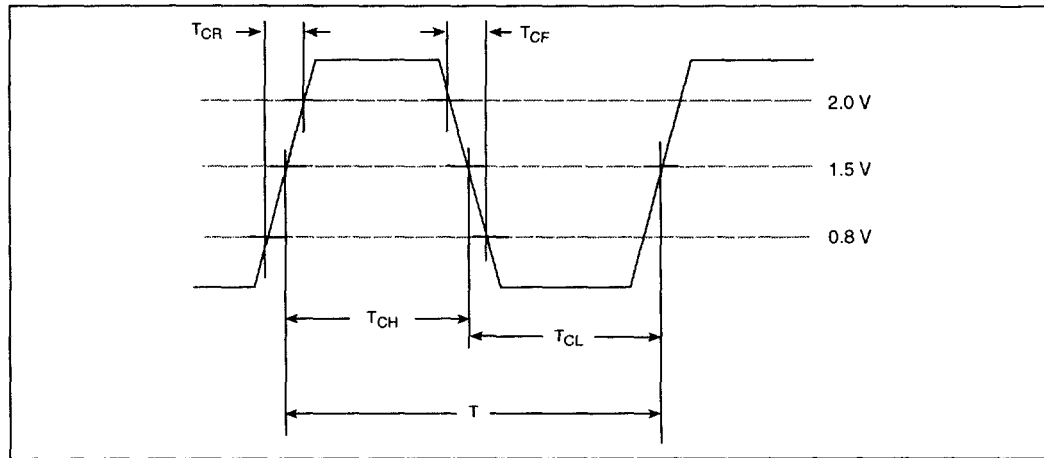


Figure 10. Output Delay Waveform

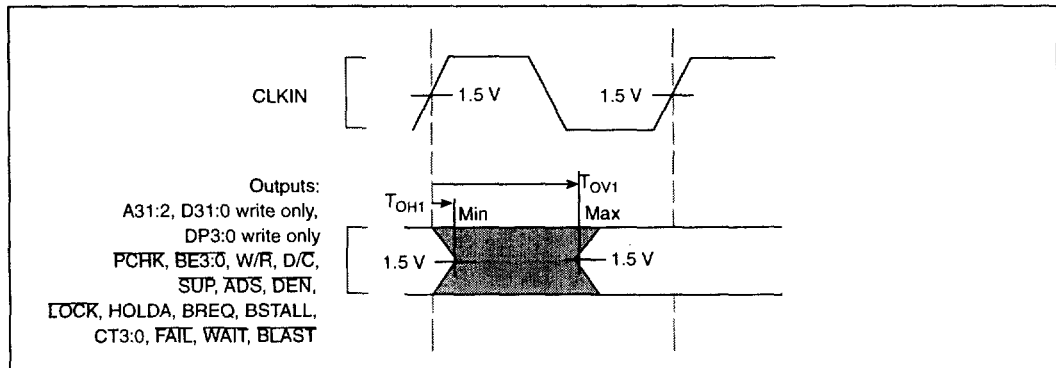
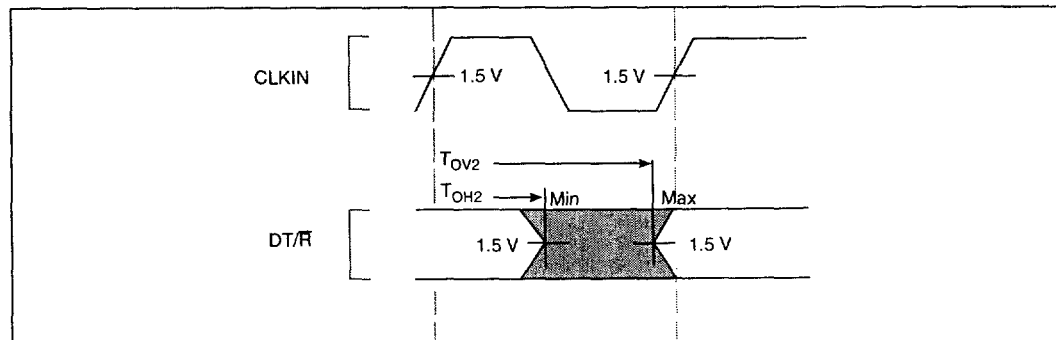
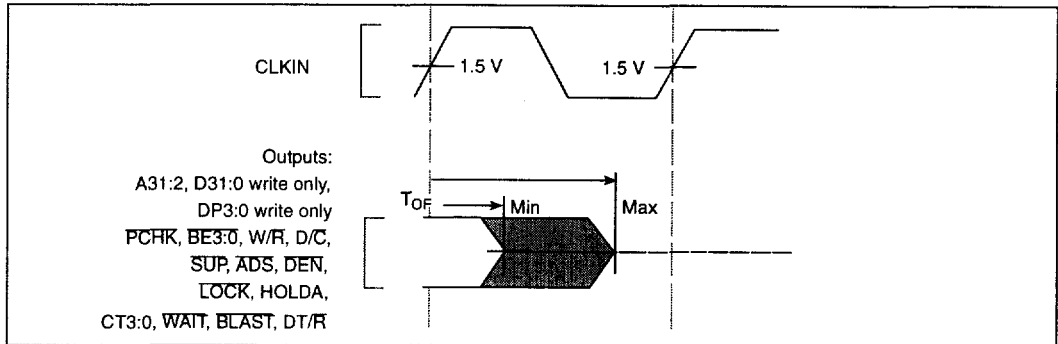


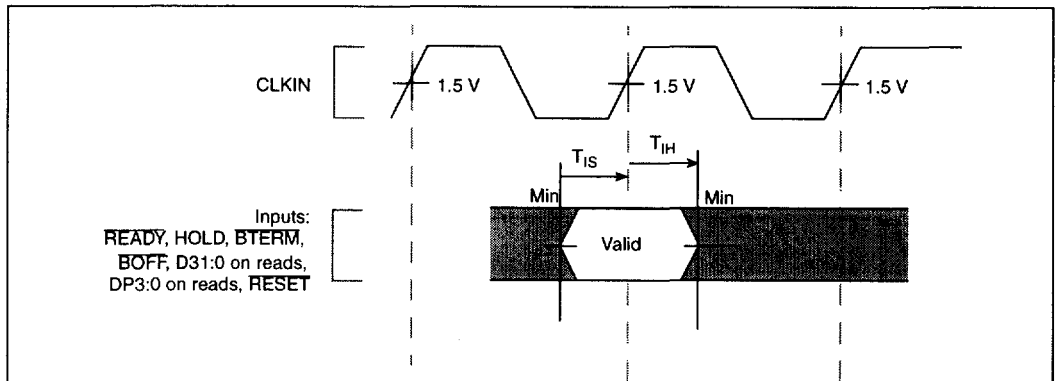
Figure 11. Output Delay Waveform



**Figure 12. Output Float Waveform**



**Figure 13. Input Setup and Hold Waveform**



**Figure 14. NMI, XINT7:0 Input Setup and Hold Waveform**

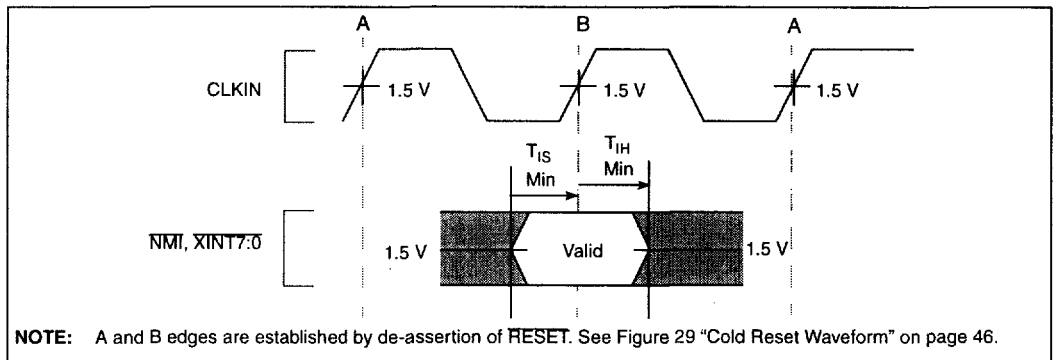




Figure 15. Hold Acknowledge Timings

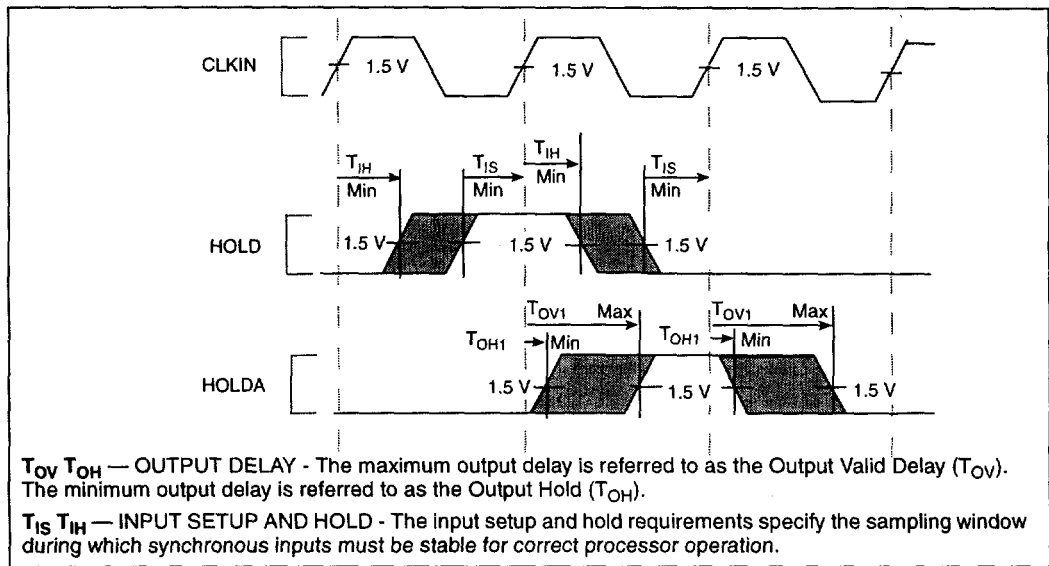


Figure 16. Bus Backoff (BOFF) Timings

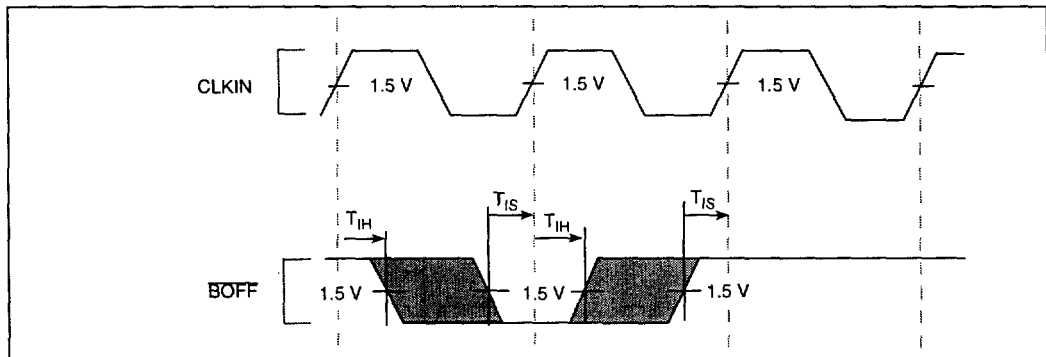


Figure 17. TCK Waveform

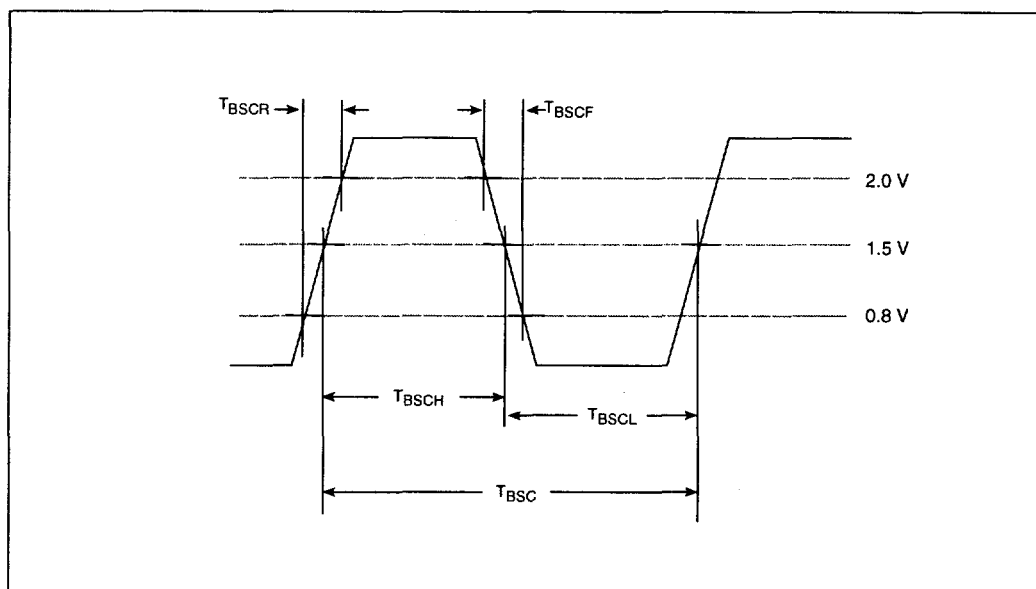


Figure 18. Input Setup and Hold Waveforms for  $T_{BSIS1}$  and  $T_{BSIH1}$

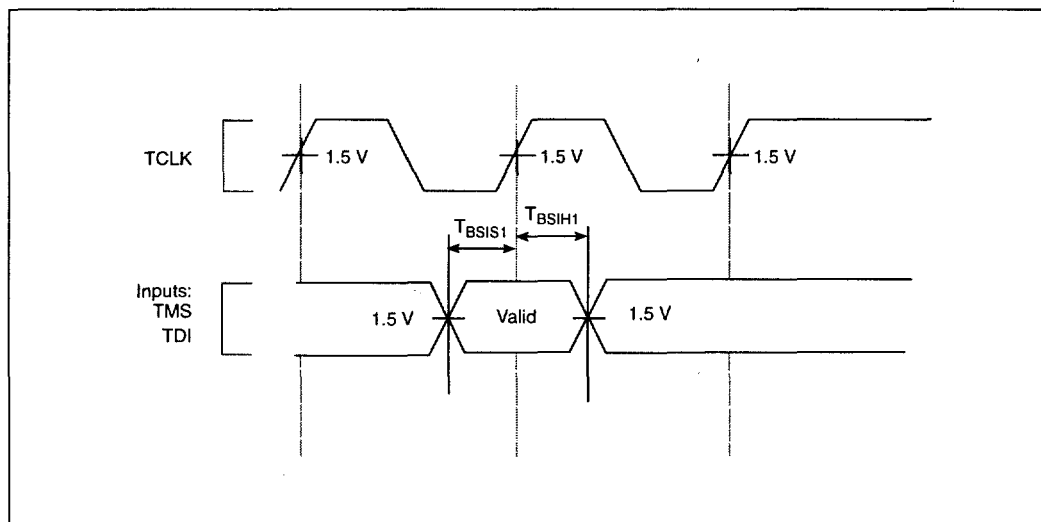


Figure 19. Output Delay and Output Float for  $T_{BSOV1}$  and  $T_{BSOF1}$

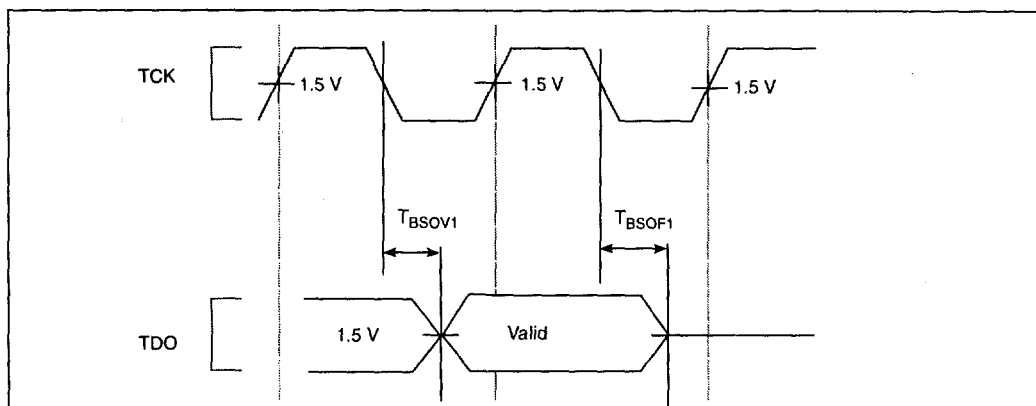


Figure 20. Output Delay and Output Float Waveform for  $T_{BSOV2}$  and  $T_{BSOF2}$

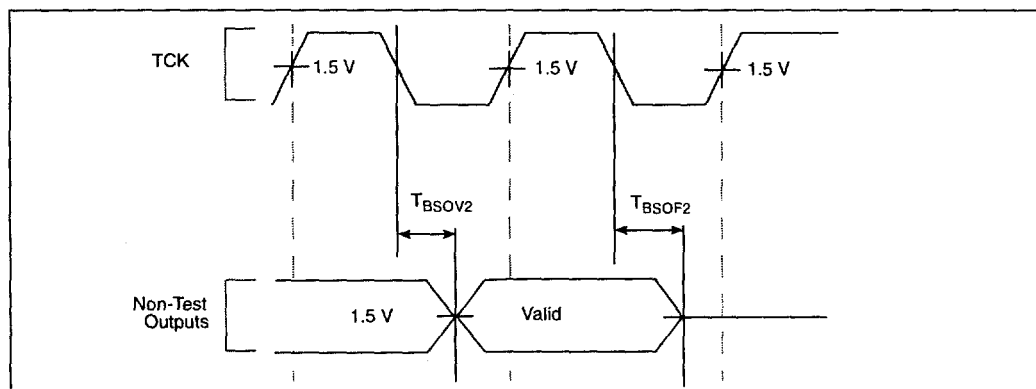


Figure 21. Input Setup and Hold Waveform for  $T_{BSIS2}$  and  $T_{BSIH2}$

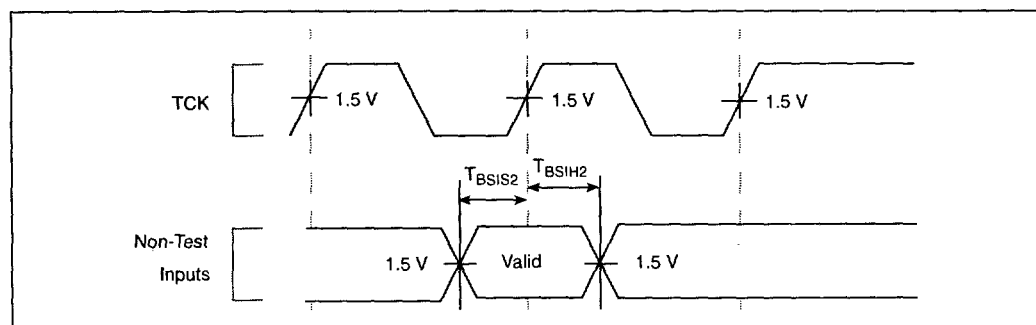


Figure 22. Rise and Fall Time Derating at 85°C and Minimum V<sub>CC</sub>

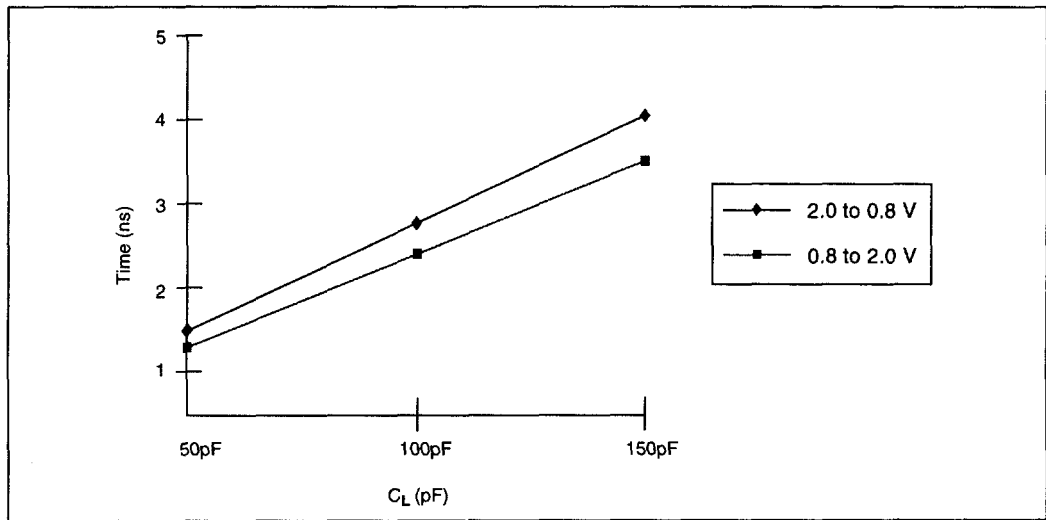


Figure 23. I<sub>CC</sub> Active (Power Supply) vs. Frequency

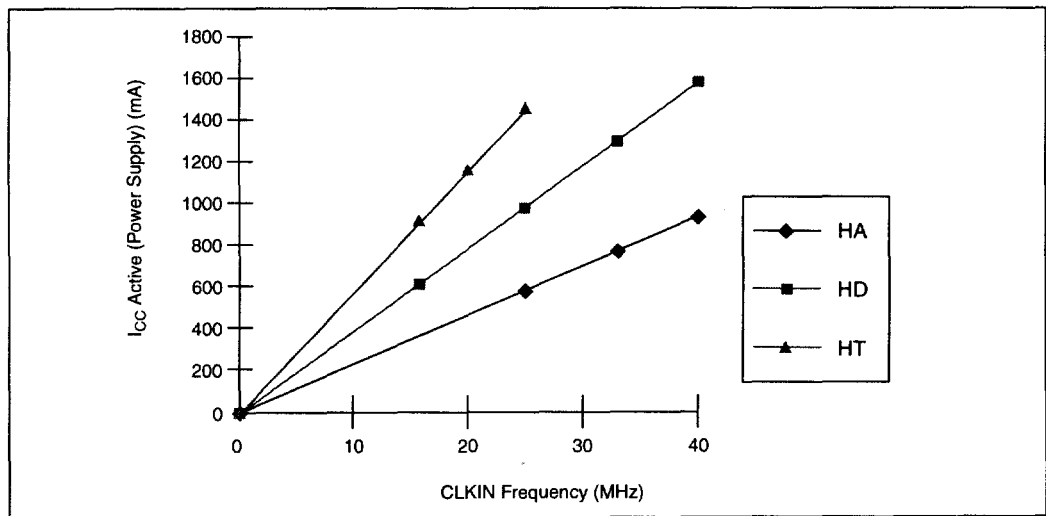


Figure 24.  $I_{CC}$  Active (Thermal) vs. Frequency

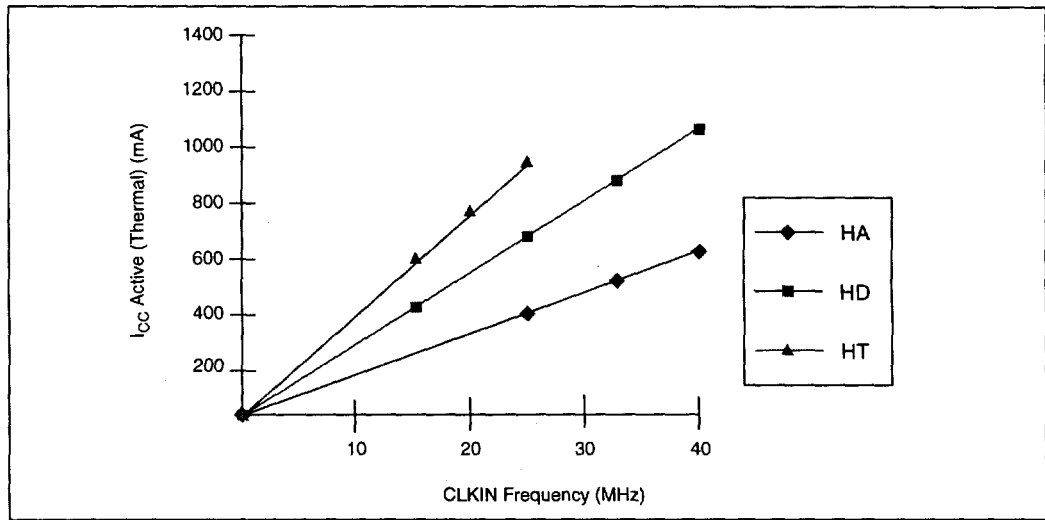
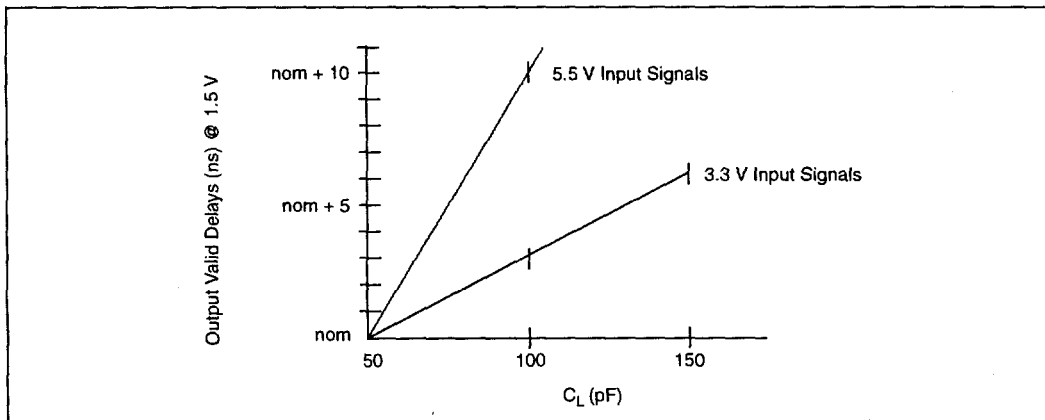
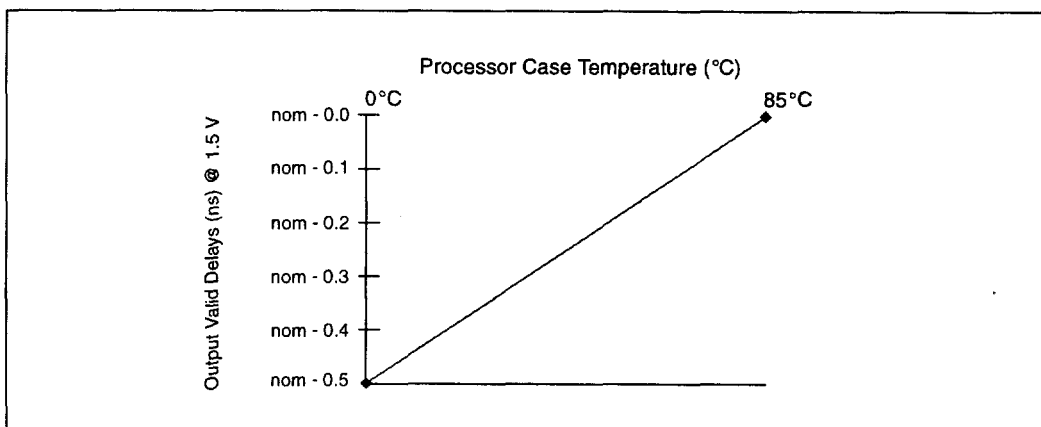


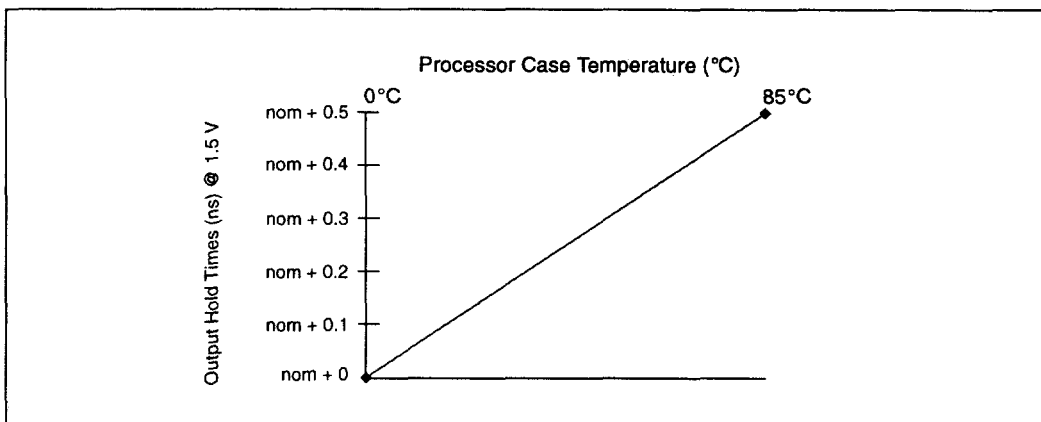
Figure 25. Output Delay or Hold vs. Load Capacitance



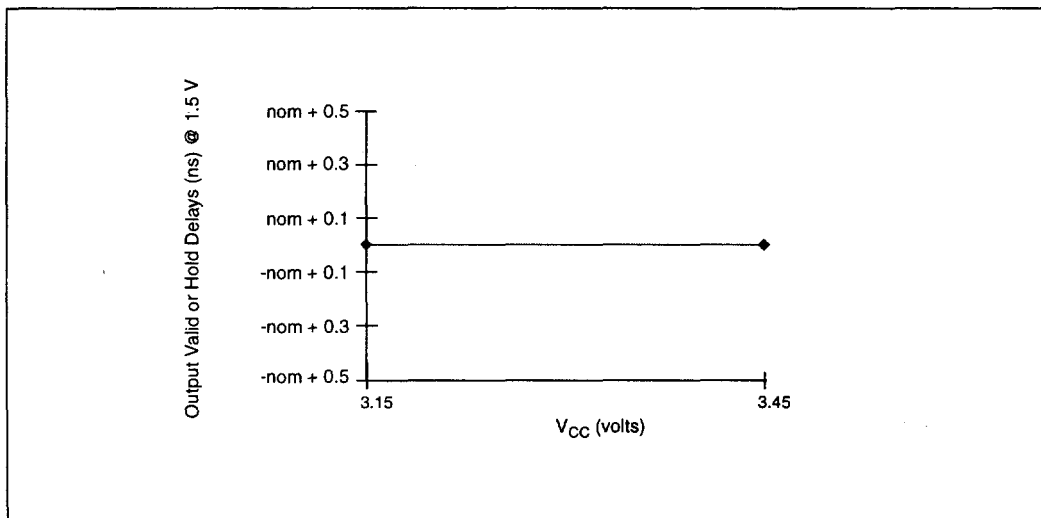
**Figure 26. Output Delay vs. Temperature**



**Figure 27. Output Hold Times vs. Temperature**



**Figure 28. Output Delay vs. V<sub>CC</sub>**



## 5.0 Bus Waveforms

Figure 29. Cold Reset Waveform

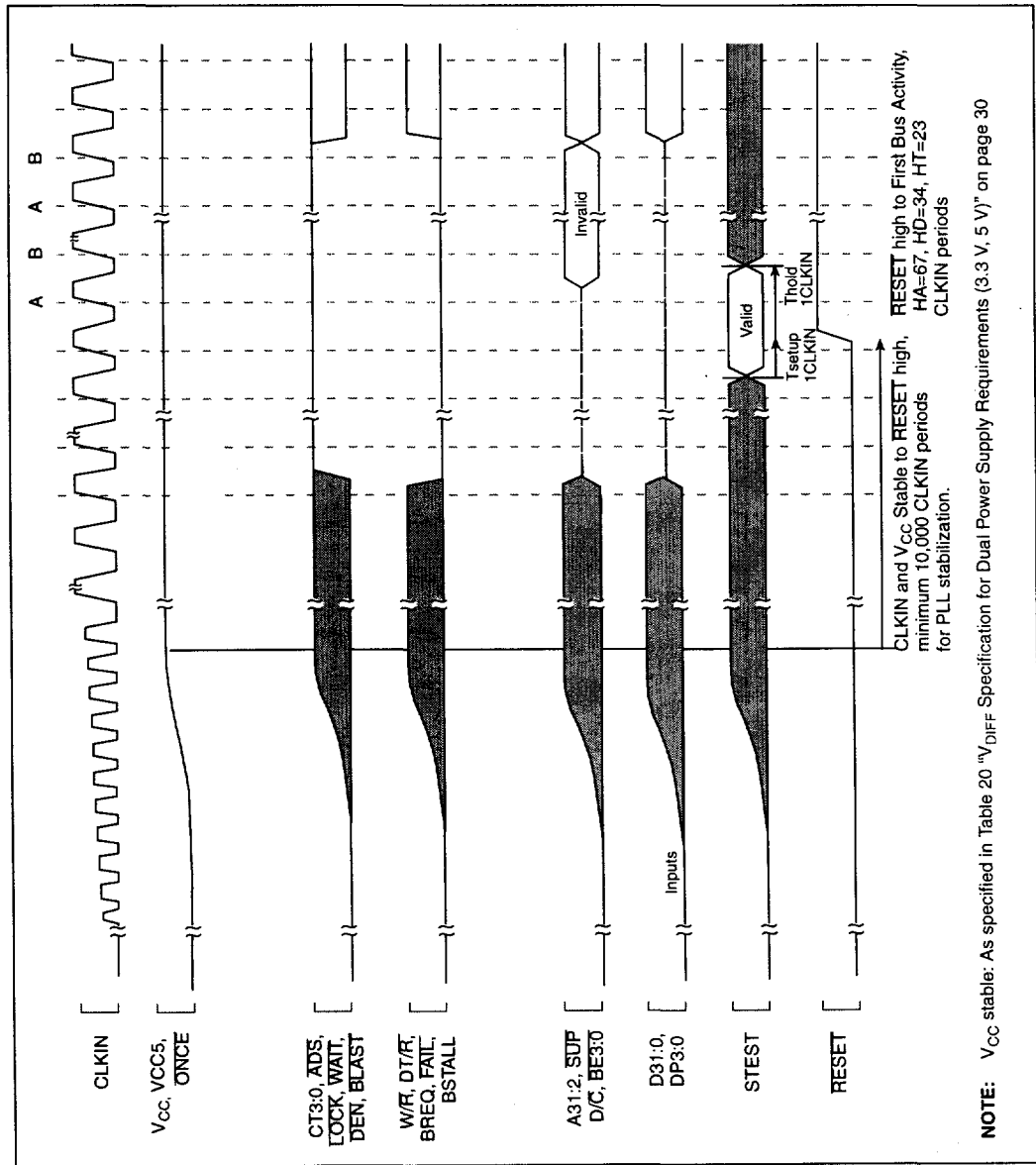


Figure 30. Warm Reset Waveform

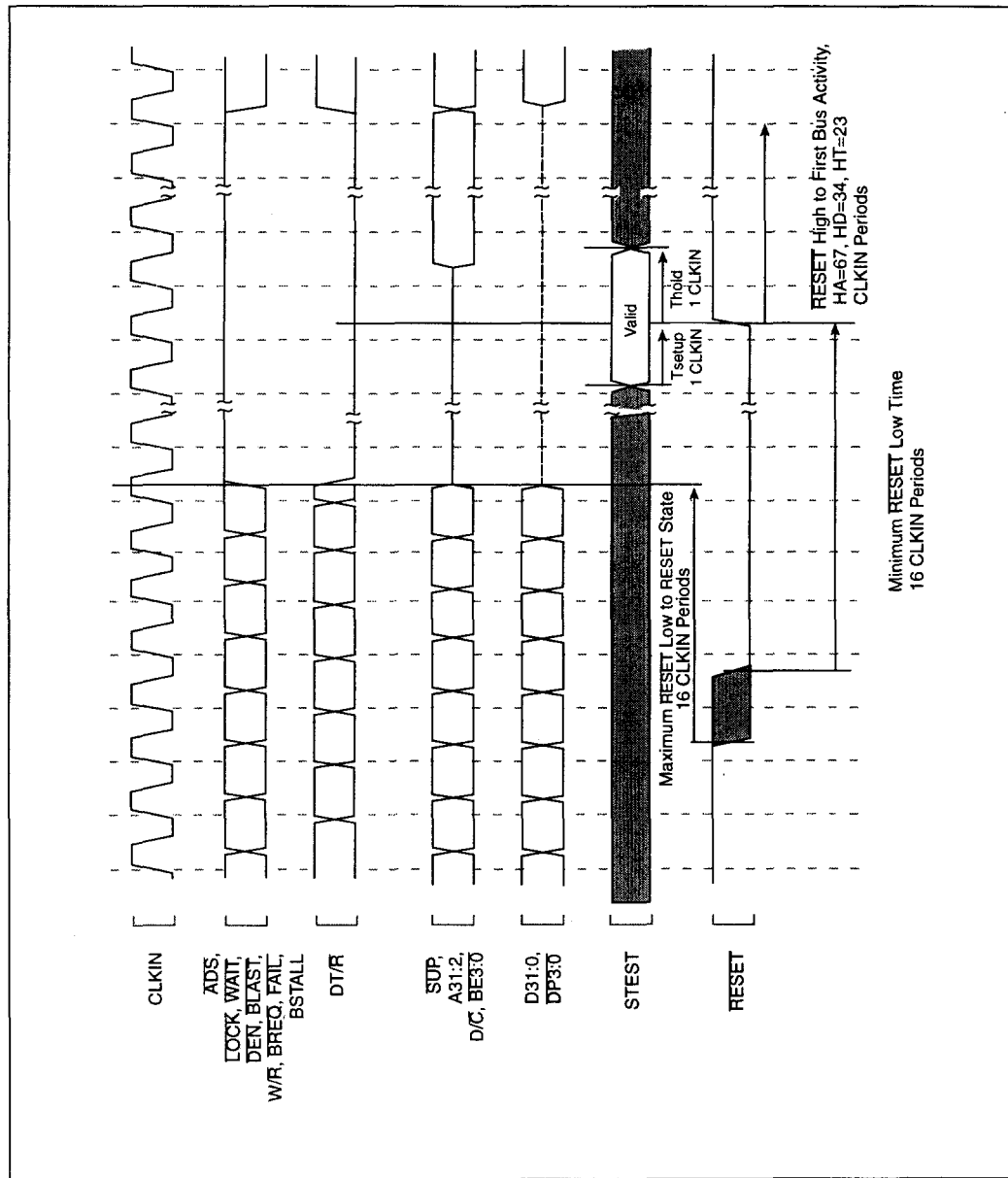
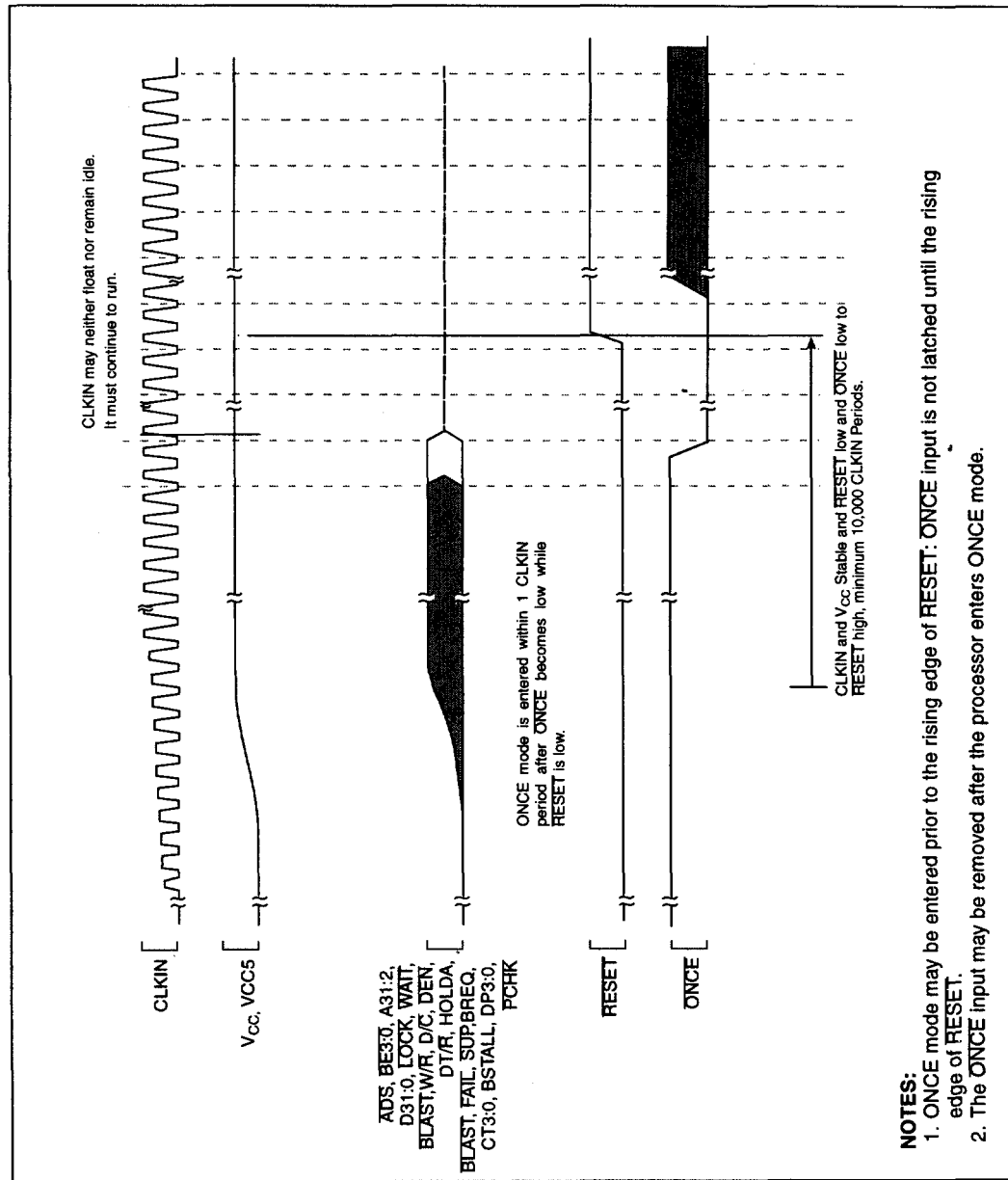




Figure 31. Entering ONCE Mode



**Figure 32. Non-Burst, Non-Pipelined Requests without Wait States**

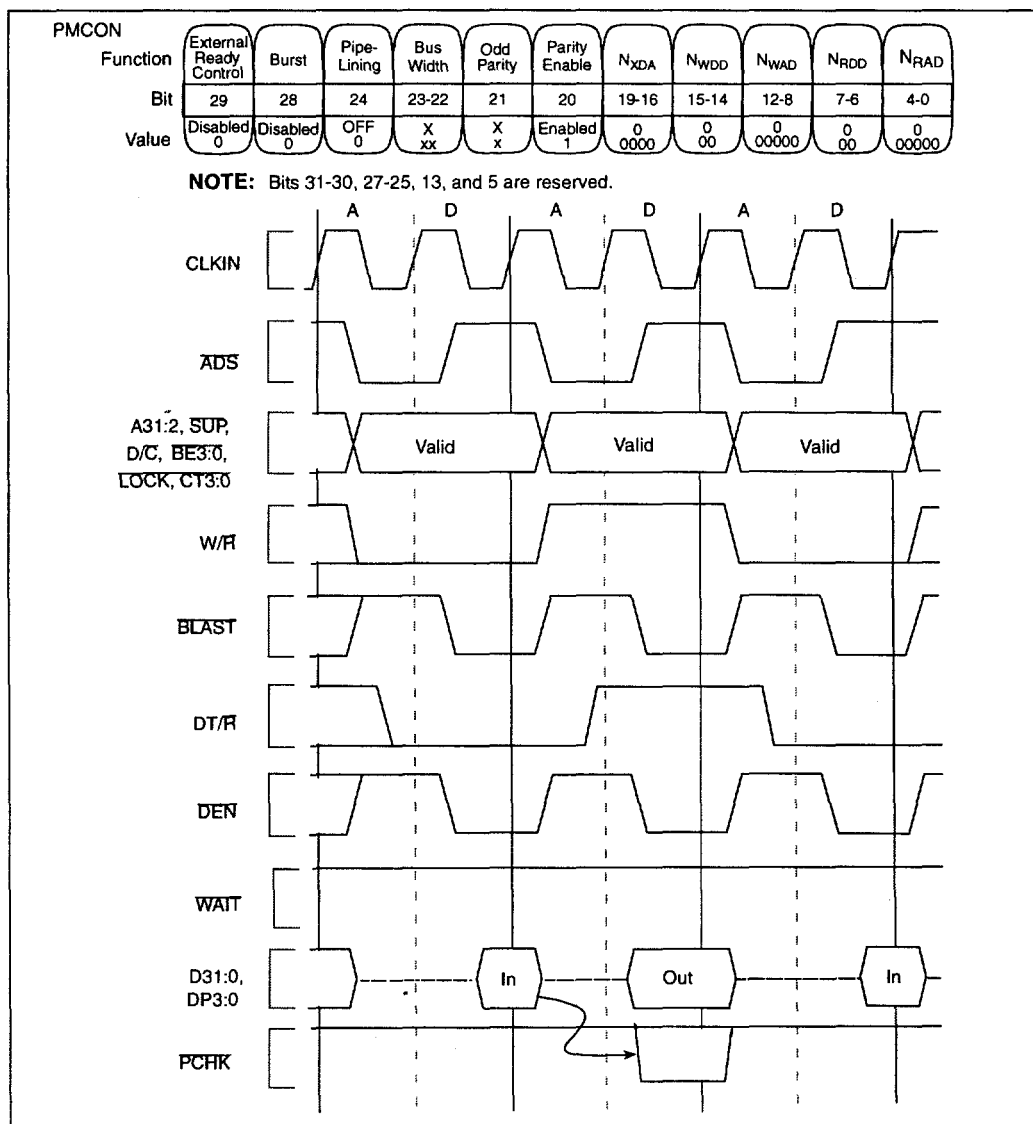
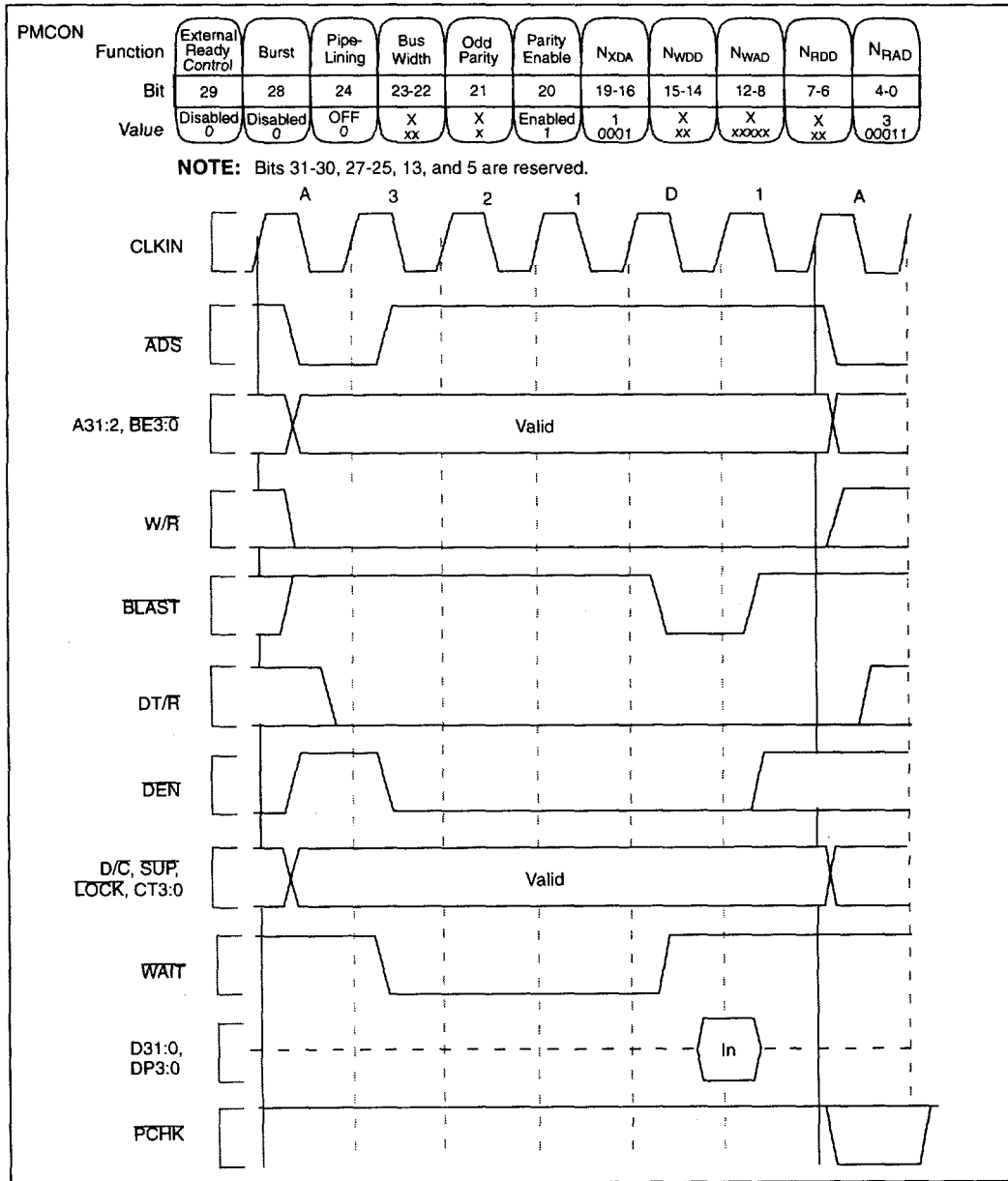
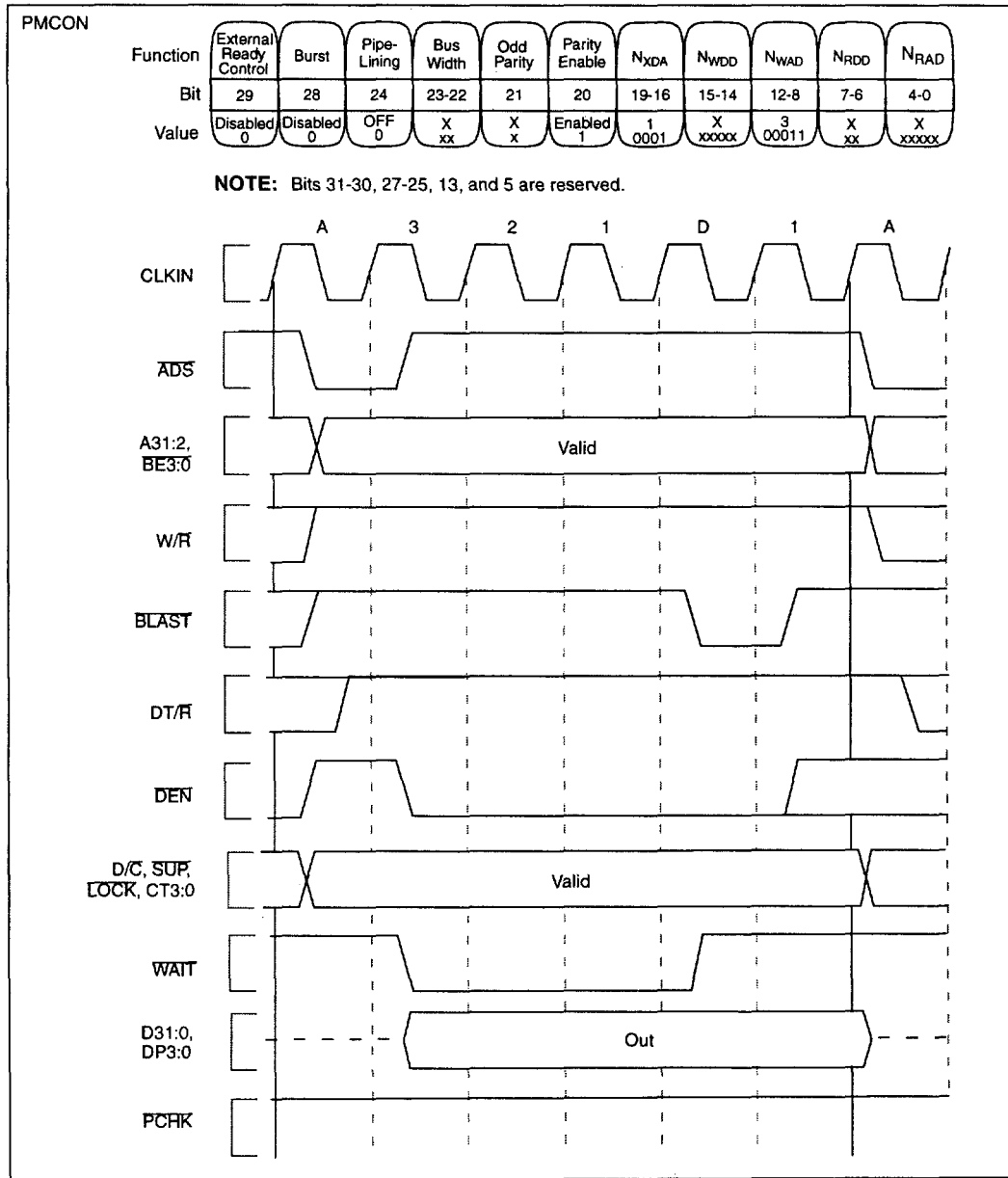
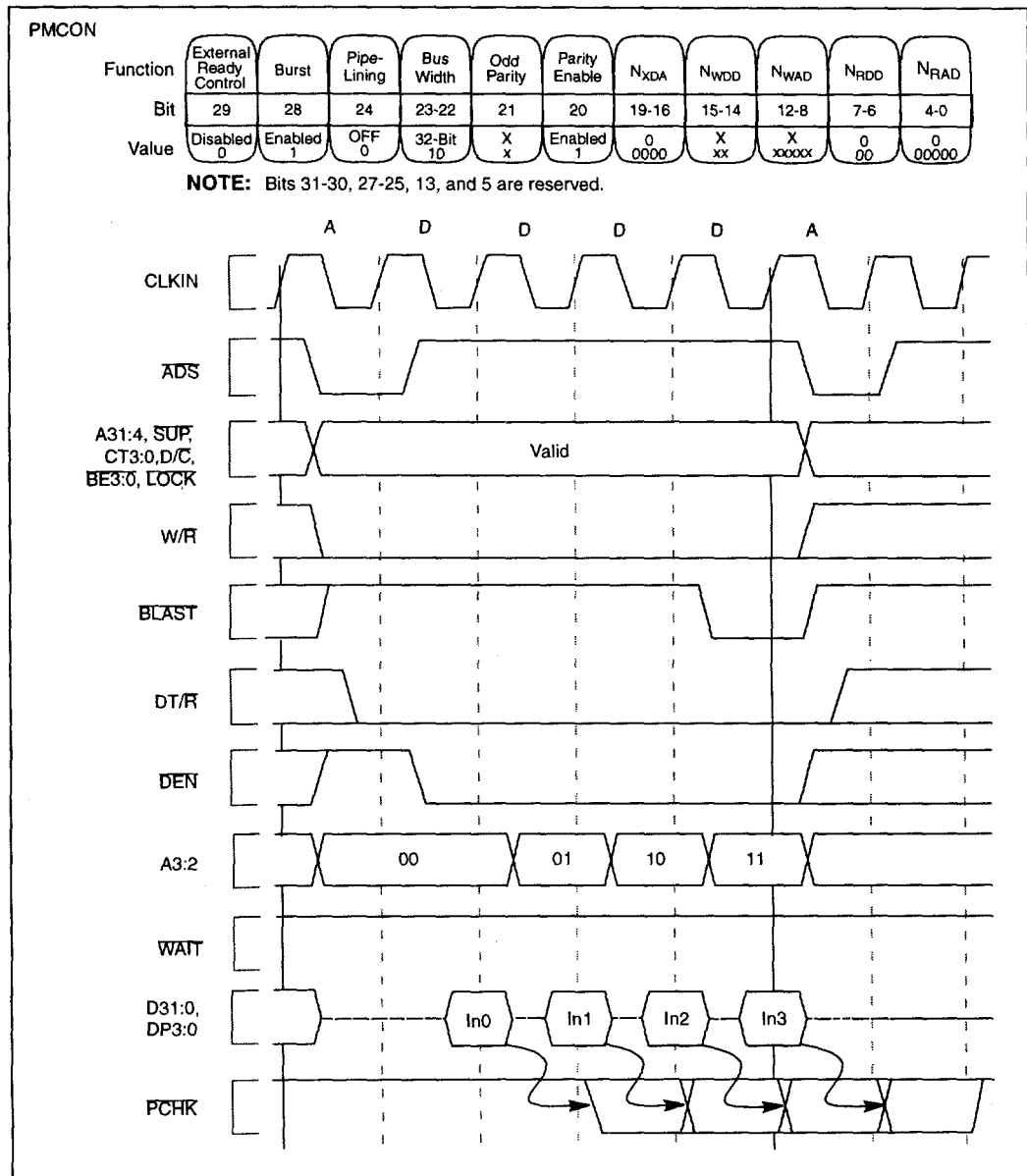


Figure 33. Non-Burst, Non-Pipelined Read Request with Wait States



**Figure 34. Non-Burst, Non-Pipelined Write Request with Wait States**



**Figure 35. Burst, Non-Pipelined Read Request without Wait States, 32-Bit Bus**


**Figure 36. Burst, Non-Pipelined Read Request with Wait States, 32-Bit Bus**

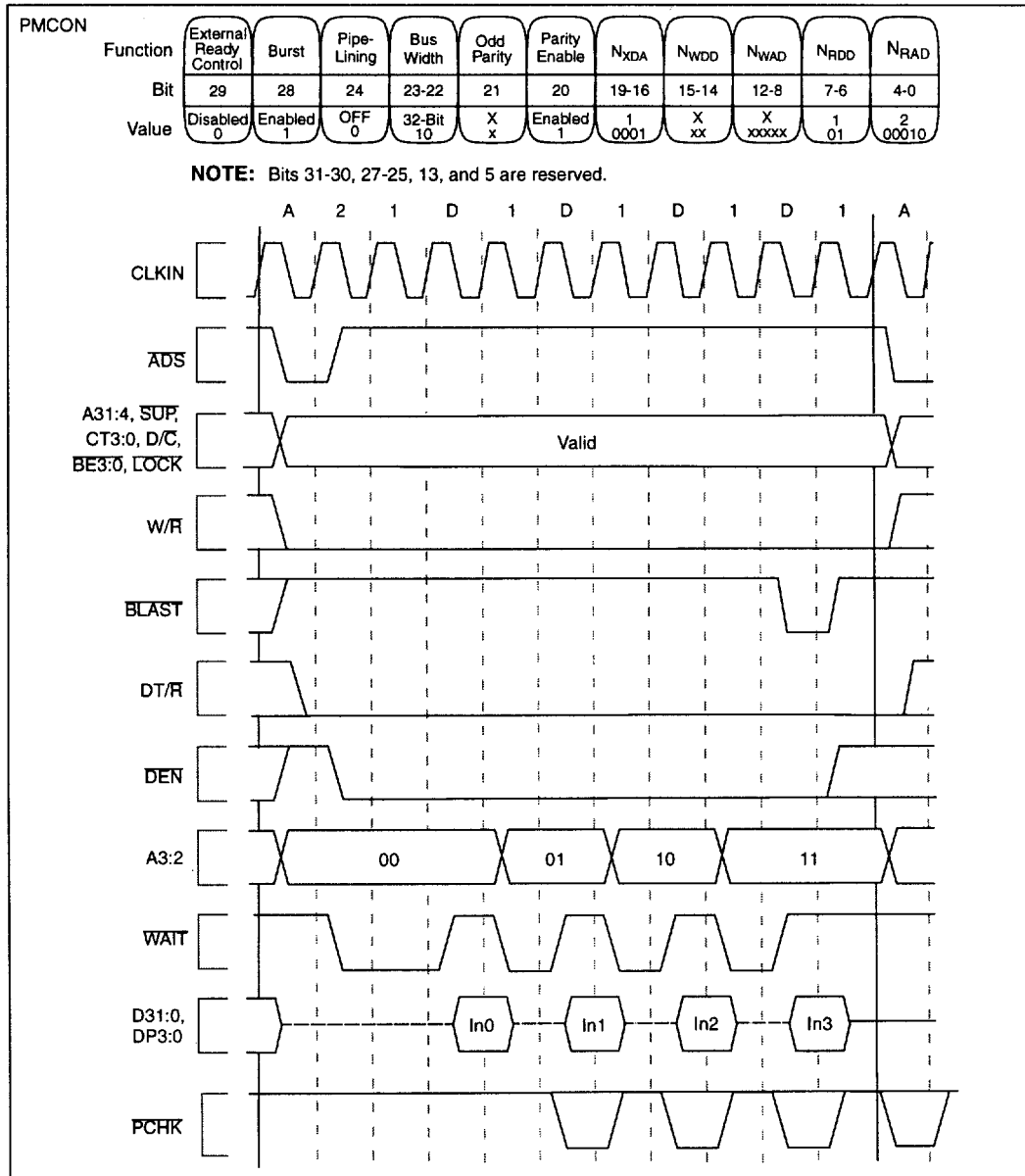
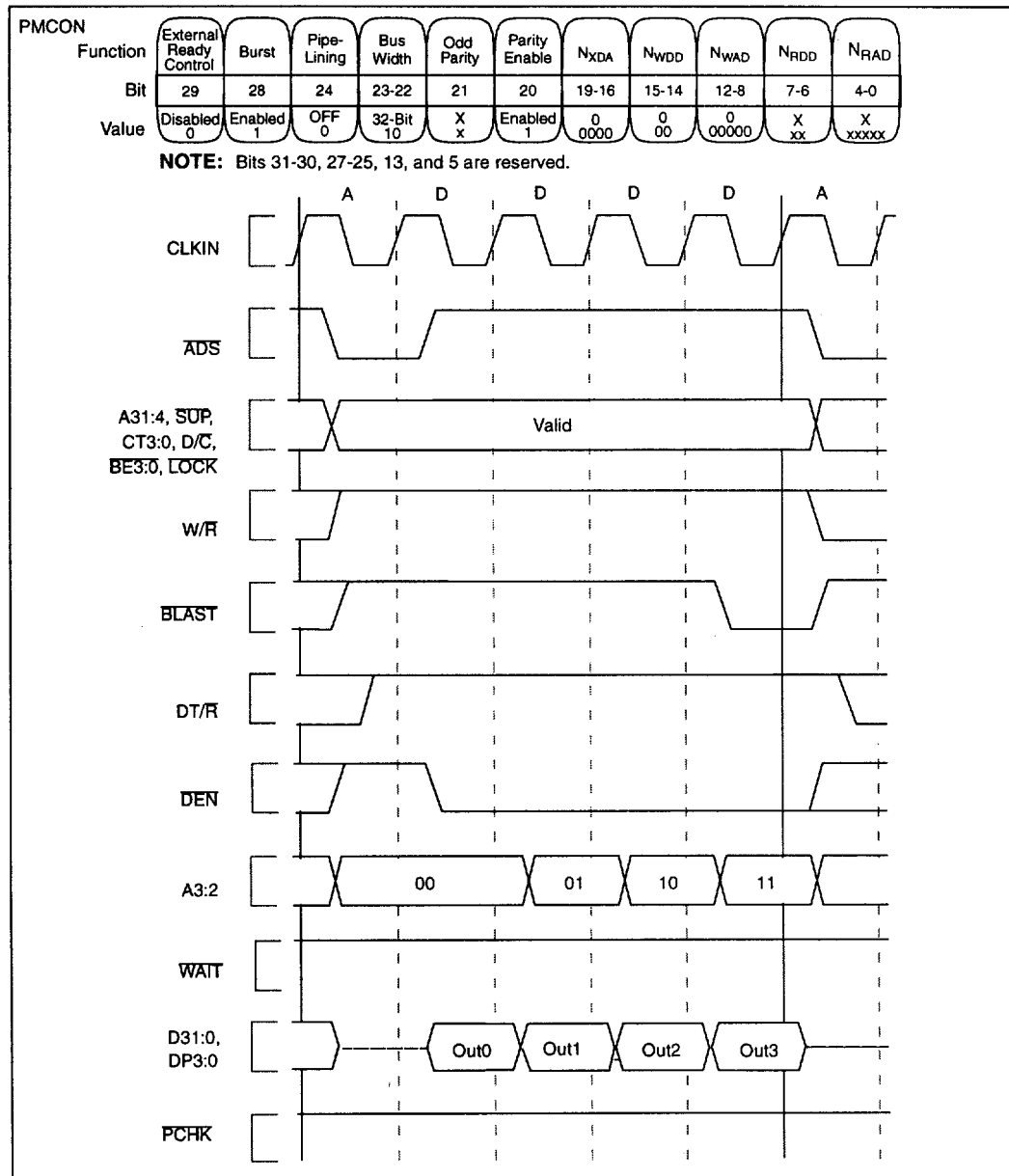


Figure 37. Burst, Non-Pipelined Write Request without Wait States, 32-Bit Bus



**Figure 38. Burst, Non-Pipelined Write Request with Wait States, 32-Bit Bus**

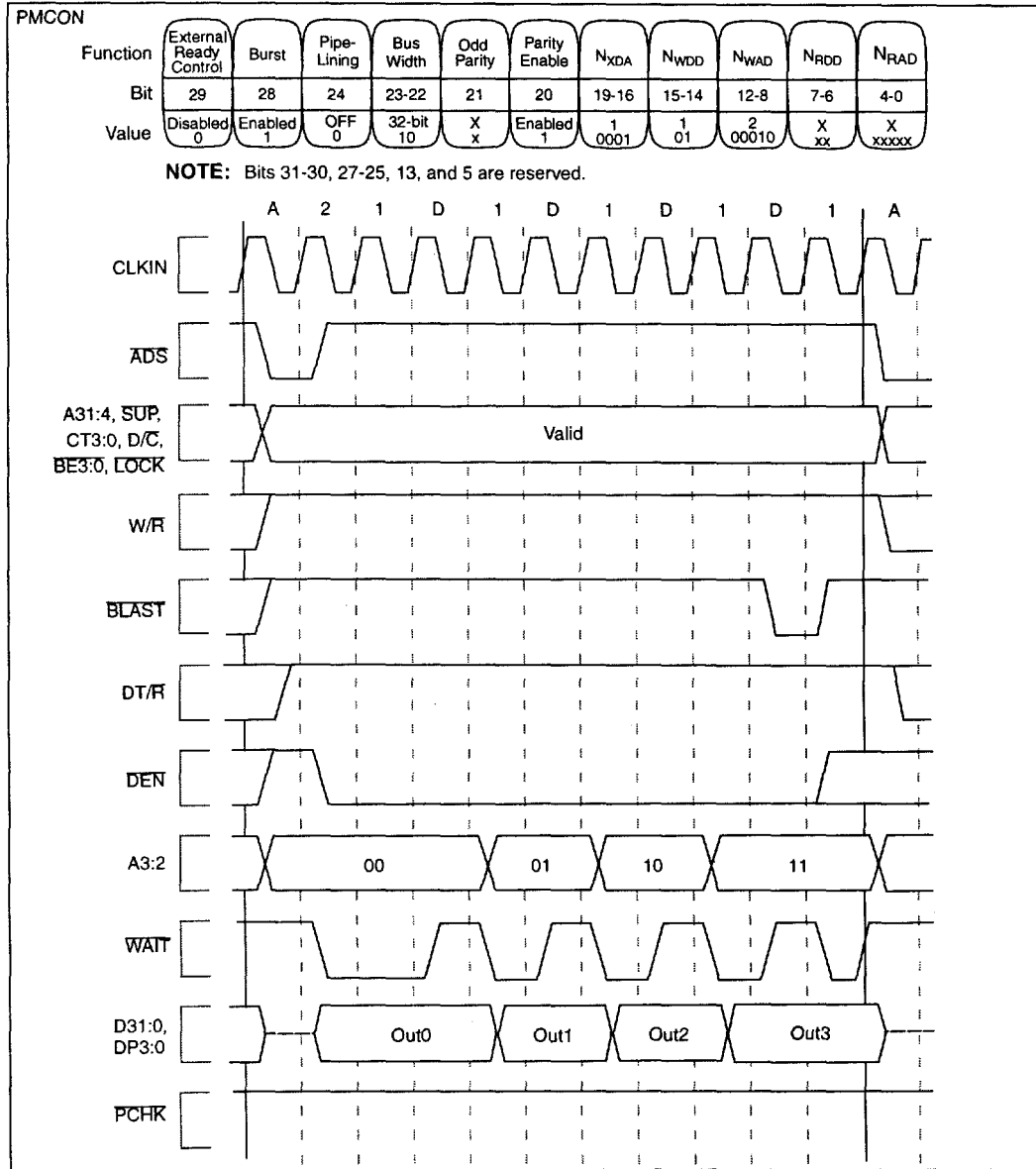
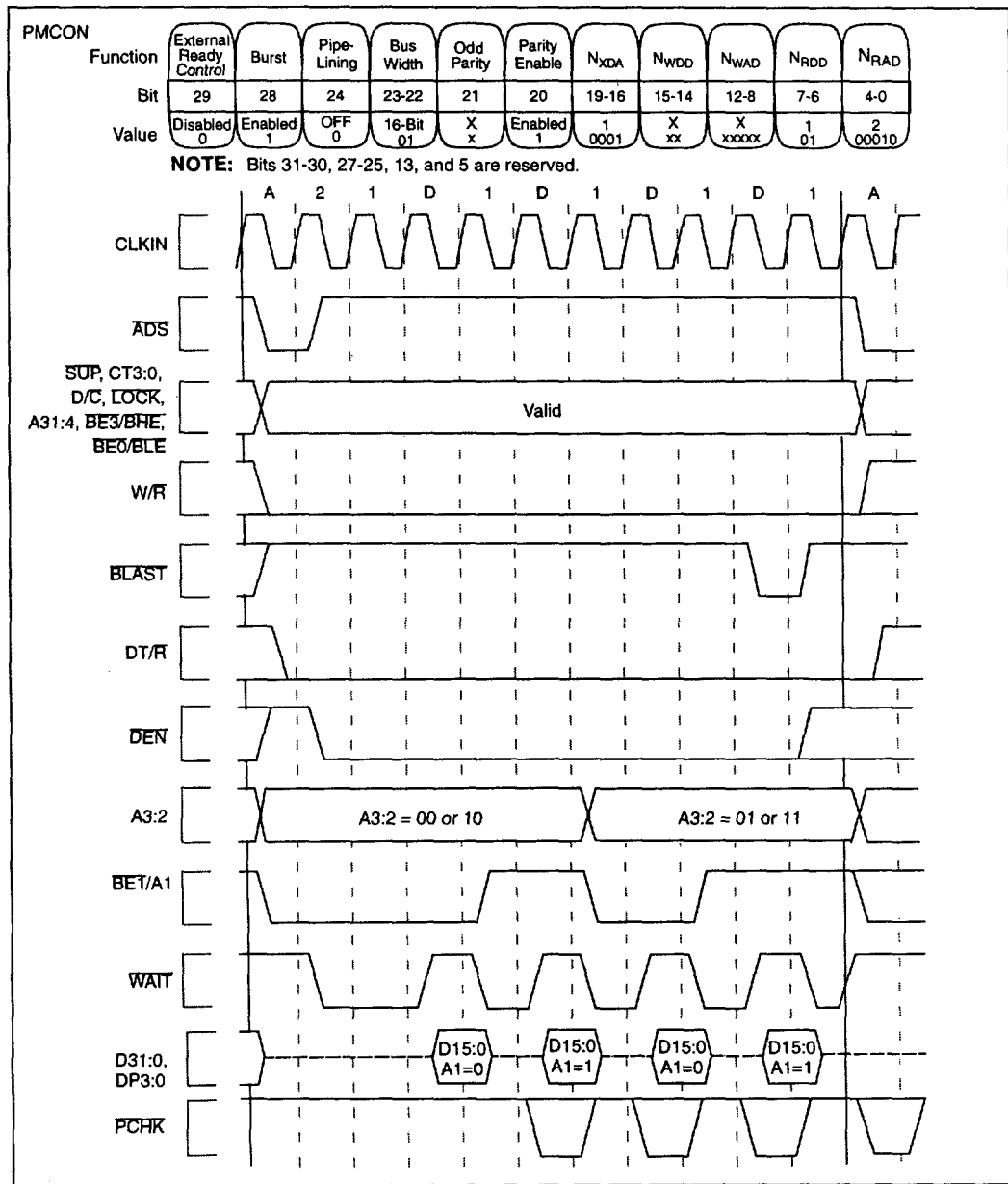
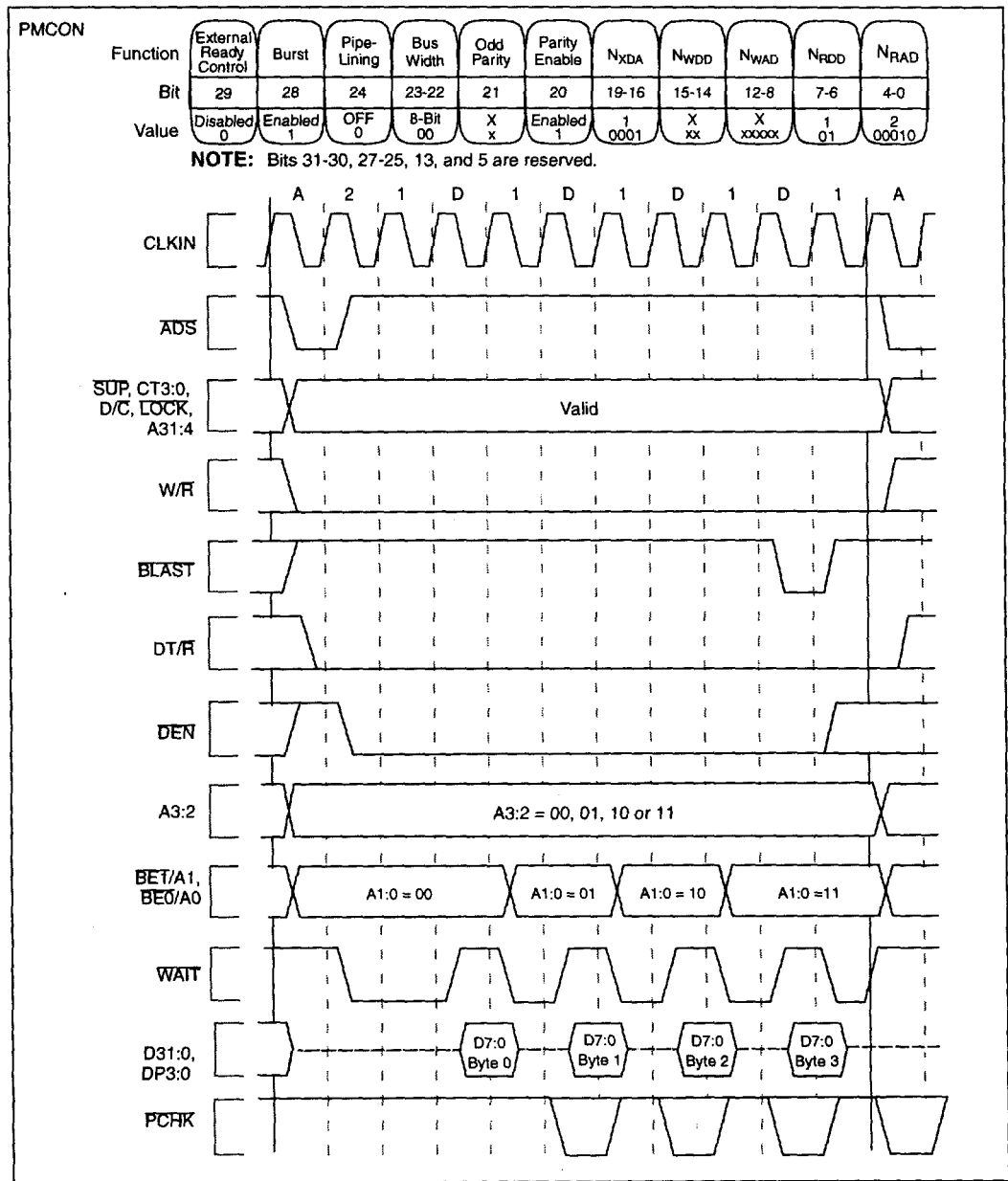




Figure 39. Burst, Non-Pipelined Read Request with Wait States, 16-Bit Bus



**Figure 40. Burst, Non-Pipelined Read Request with Wait States, 8-Bit Bus**



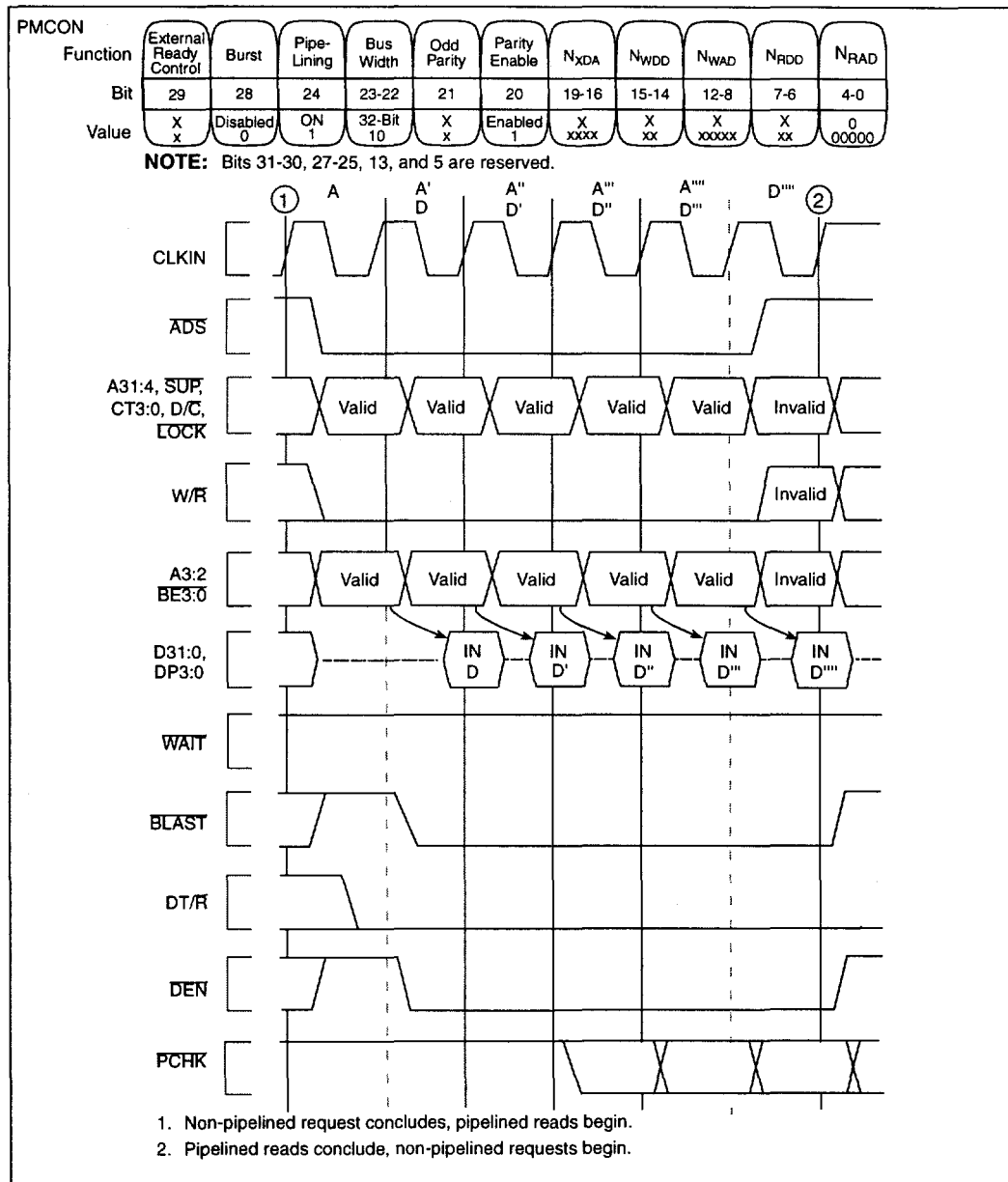
**Figure 41. Non-Burst, Pipelined Read Request without Wait States, 32-Bit Bus**


Figure 42. Non-Burst, Pipelined Read Request with Wait States, 32-Bit Bus

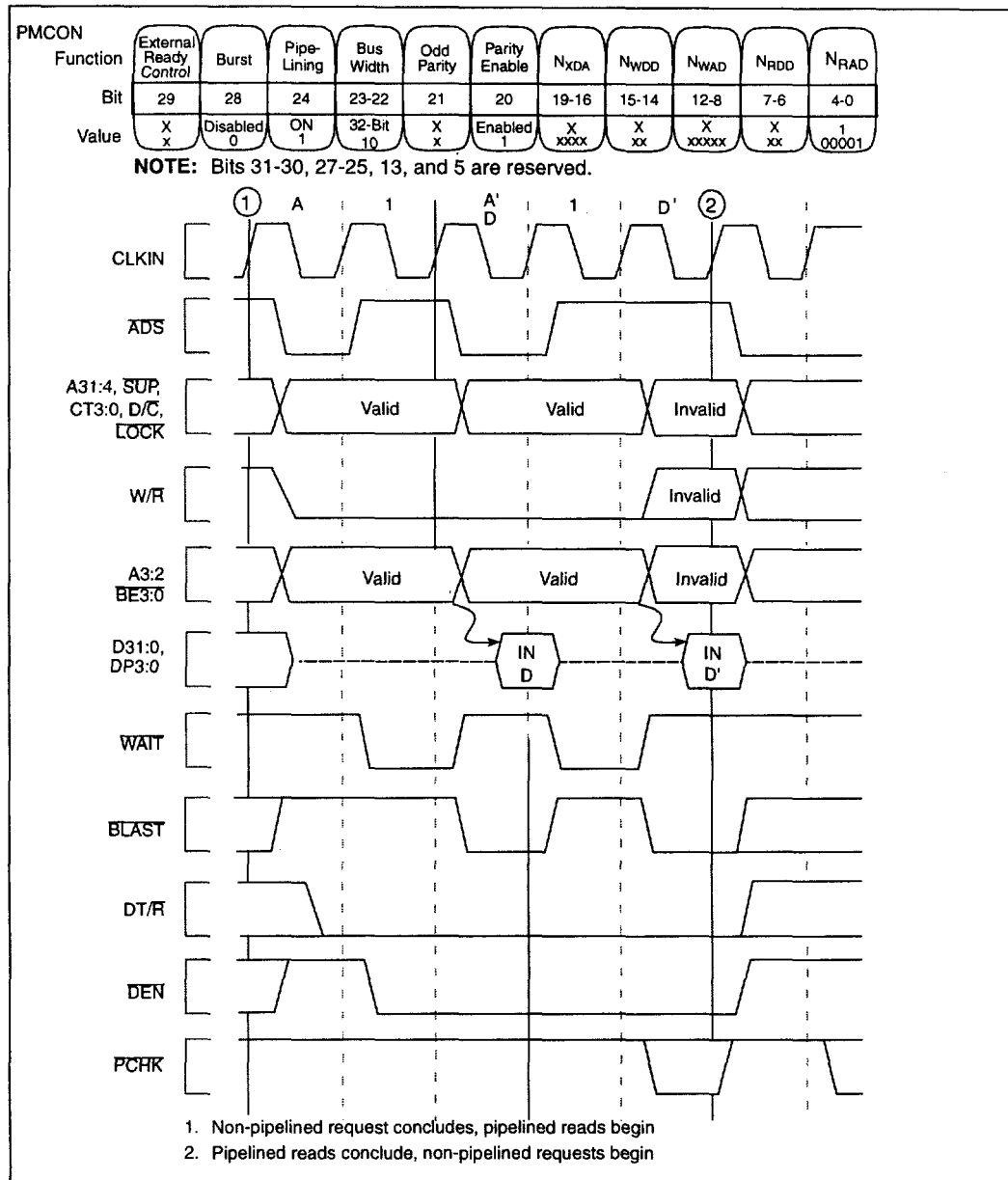


Figure 43. Burst, Pipelined Read Request without Wait States, 32-Bit Bus

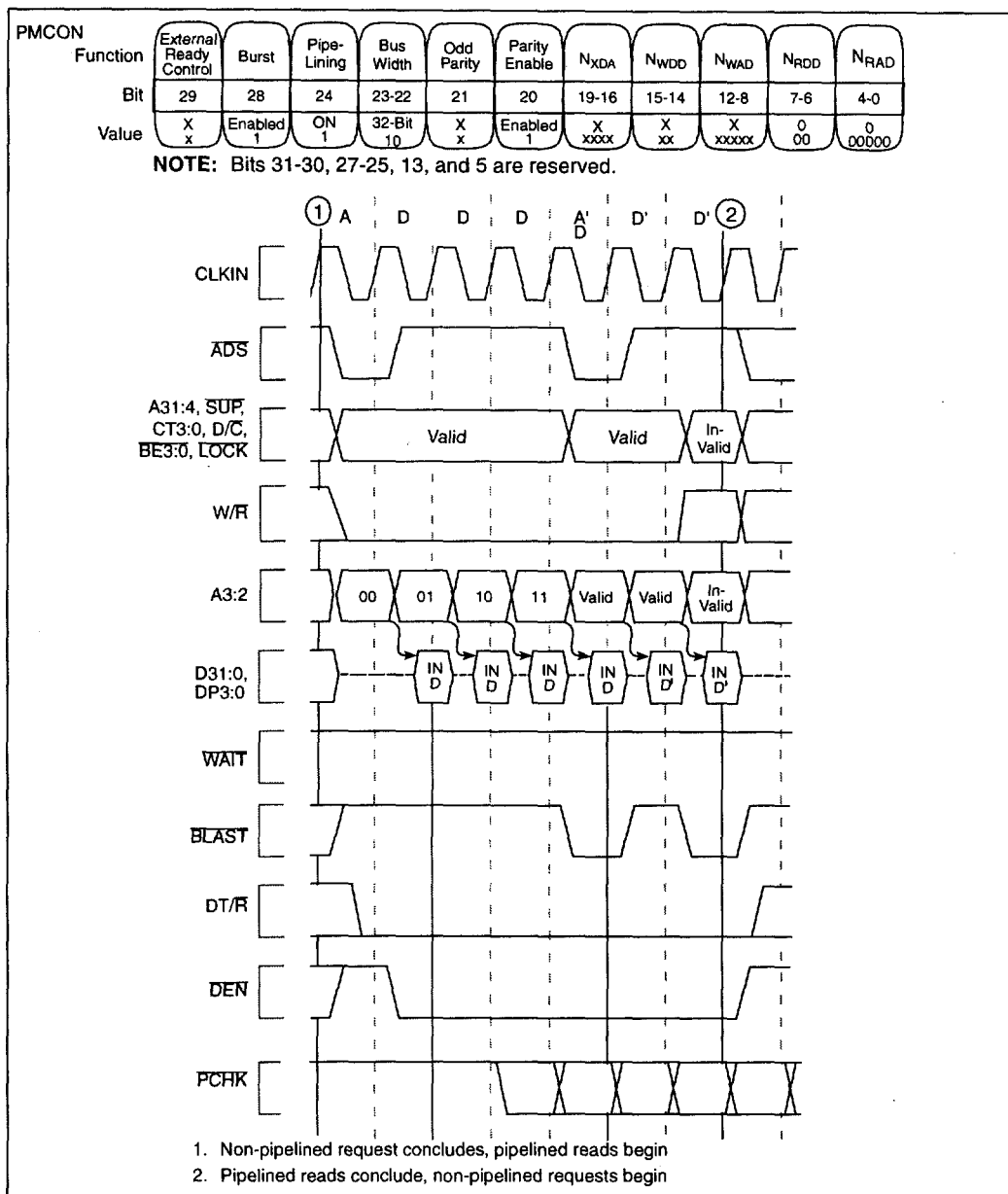
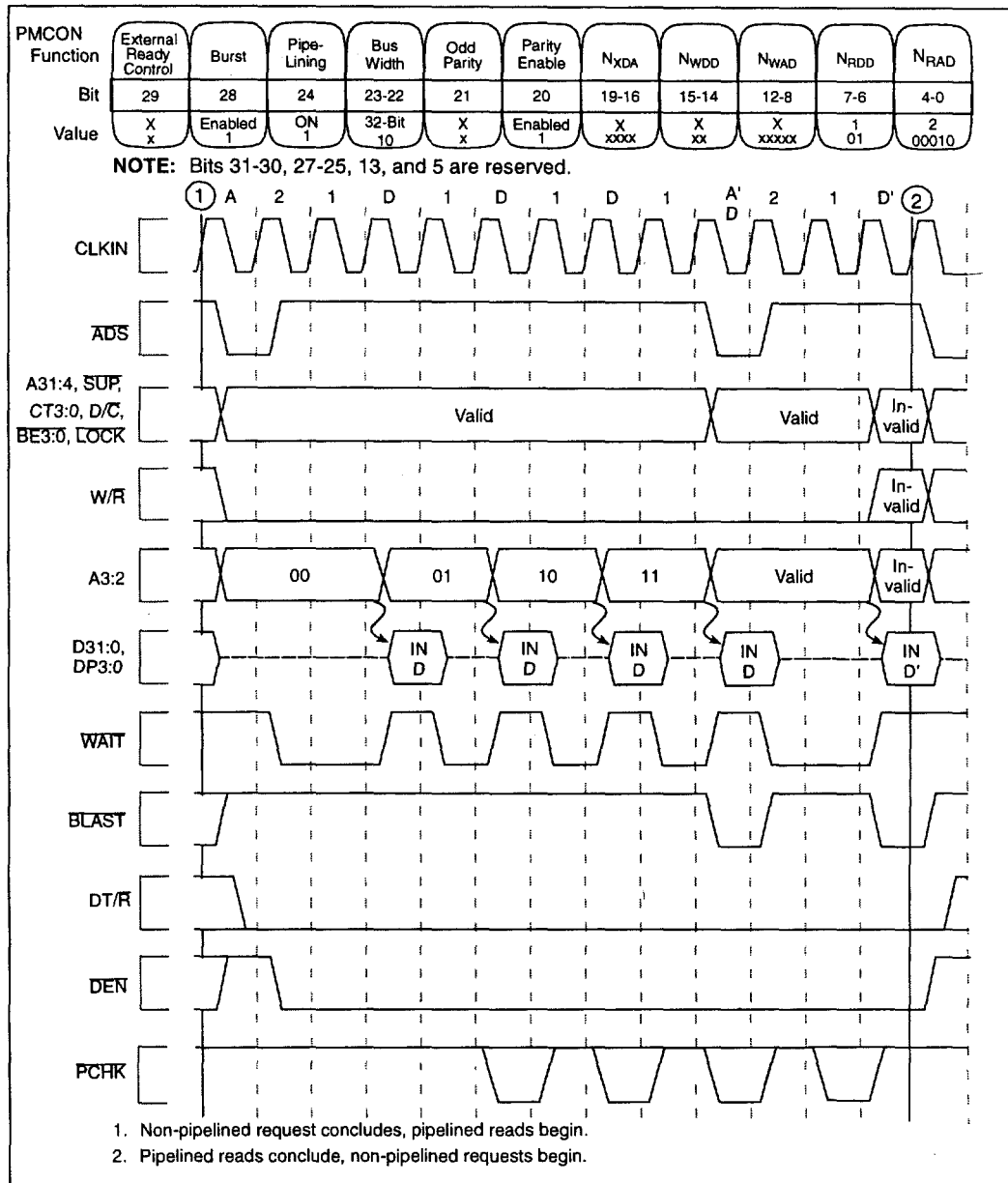


Figure 44. Burst, Pipelined Read Request with Wait States, 32-Bit Bus



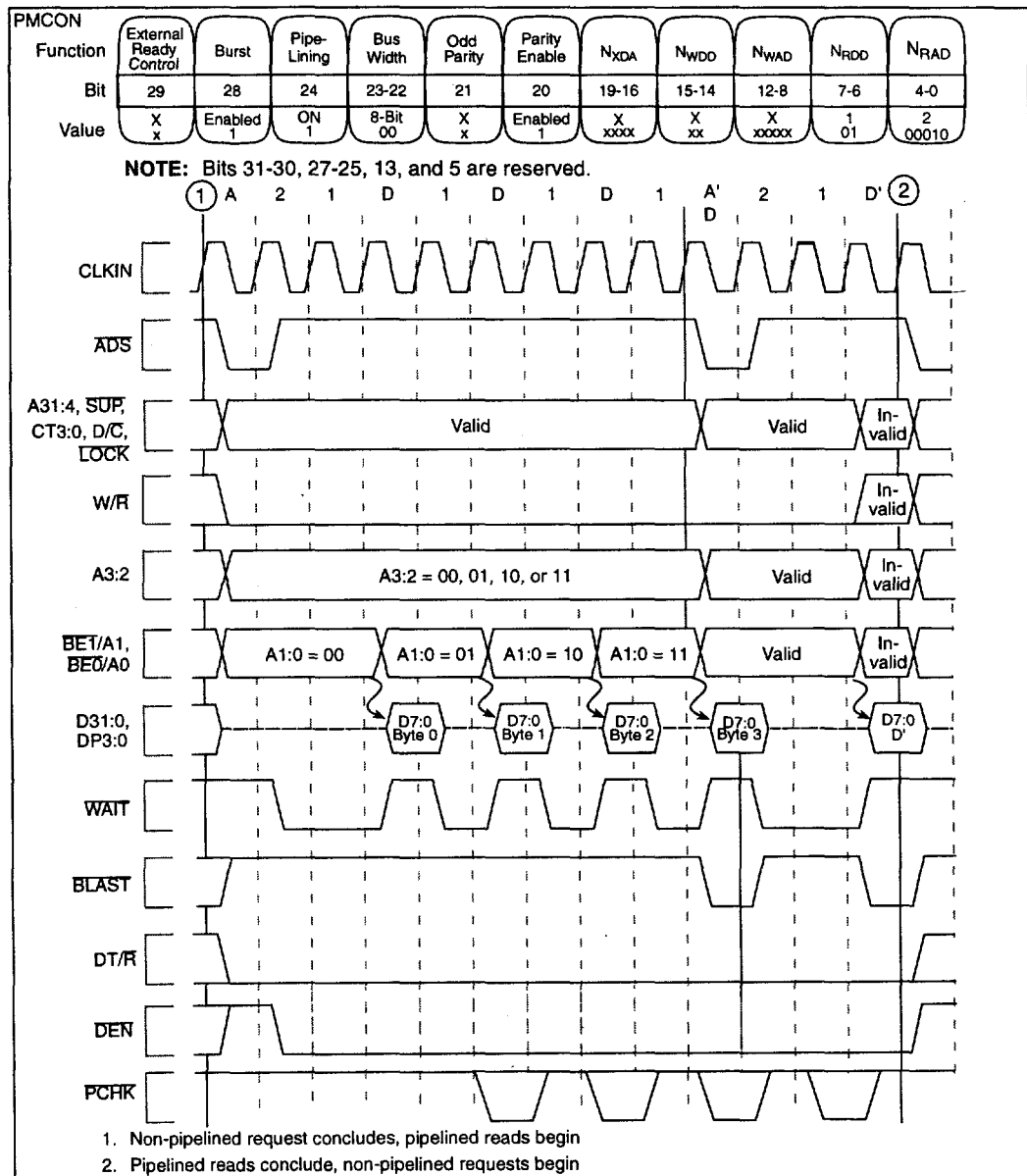
**Figure 45. Burst, Pipelined Read Request with Wait States, 8-Bit Bus**


Figure 46. Burst, Pipelined Read Request with Wait States, 16-Bit Bus

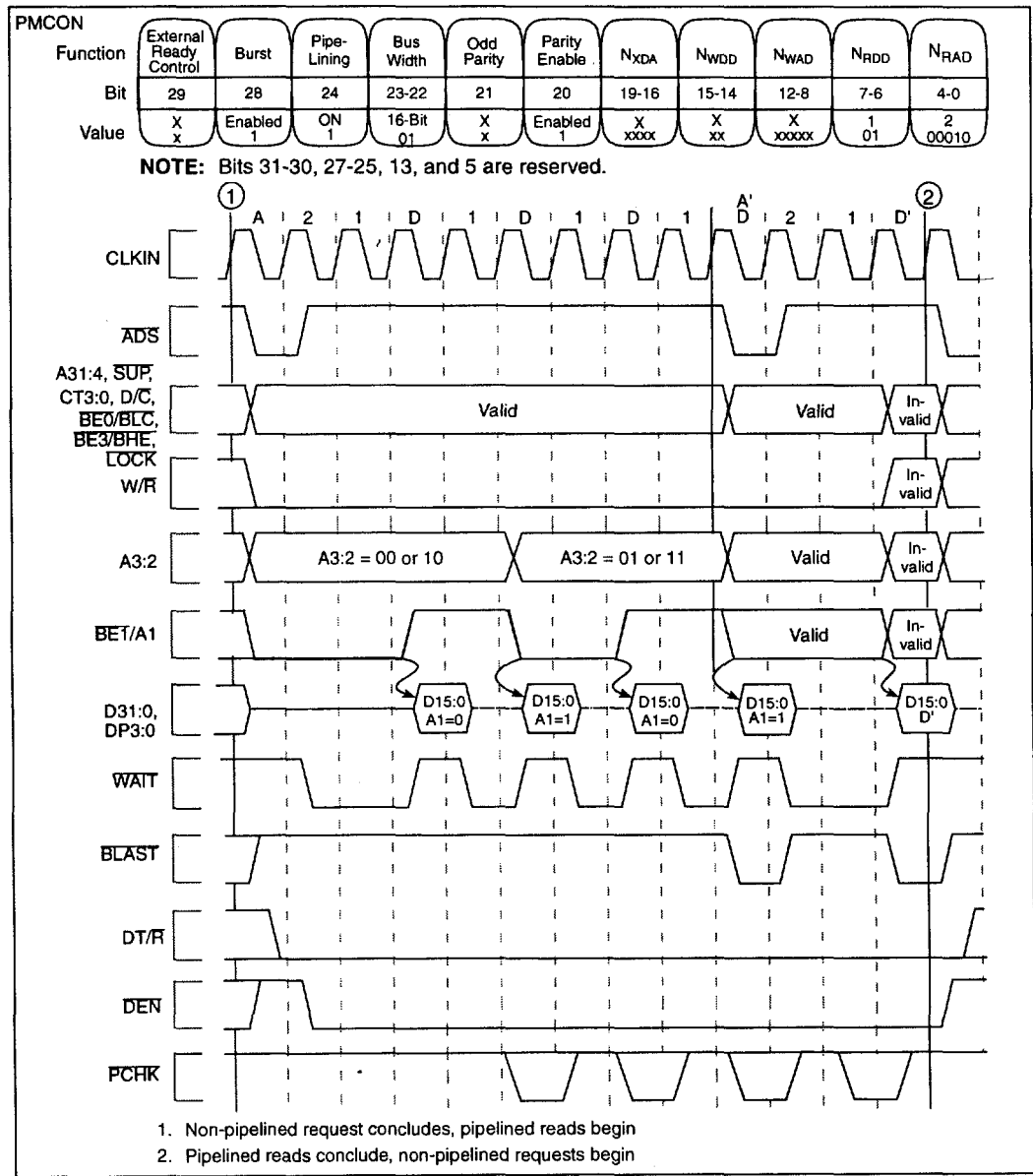




Figure 47. Using External READY

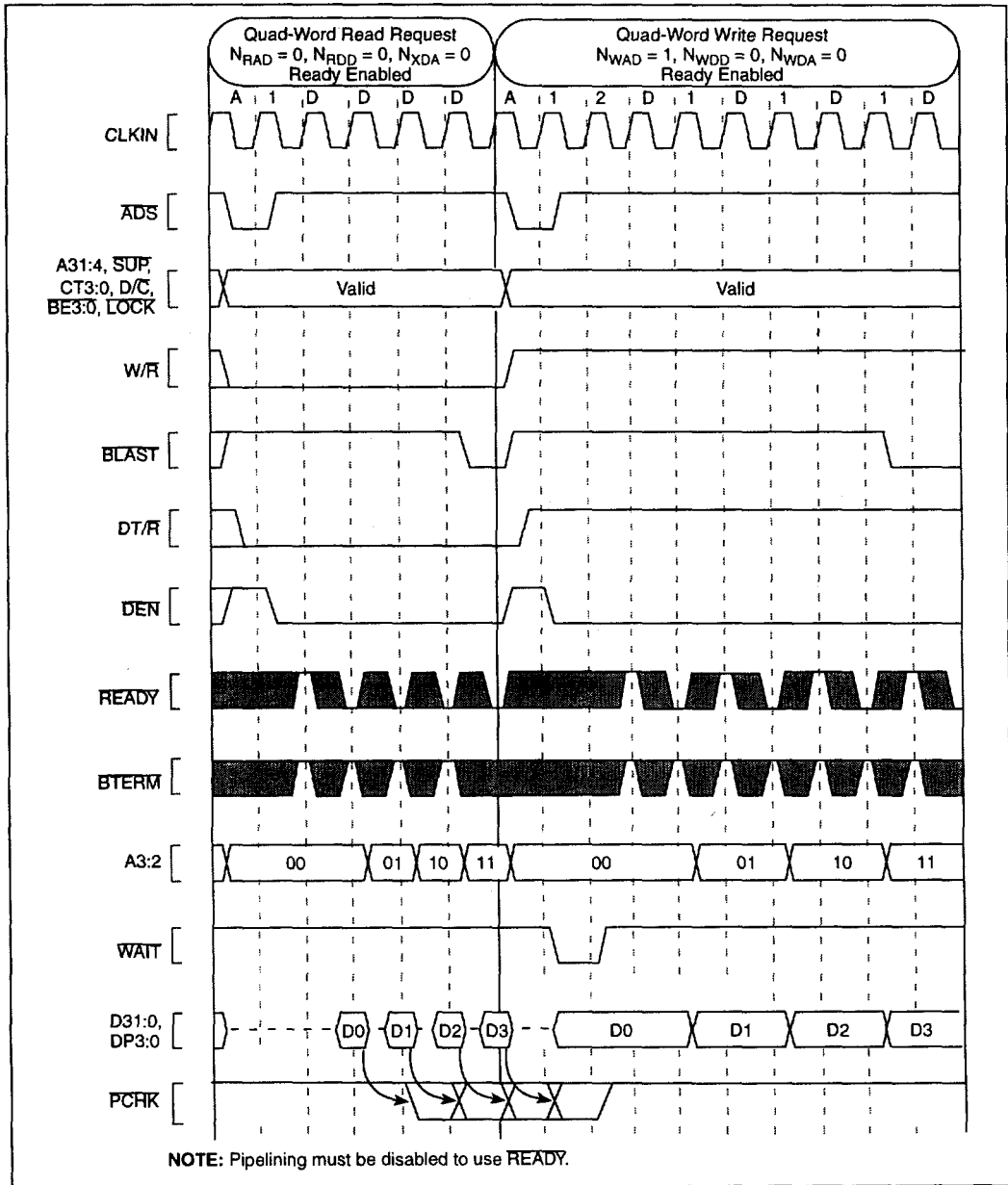


Figure 48. Terminating a Burst with BTERM

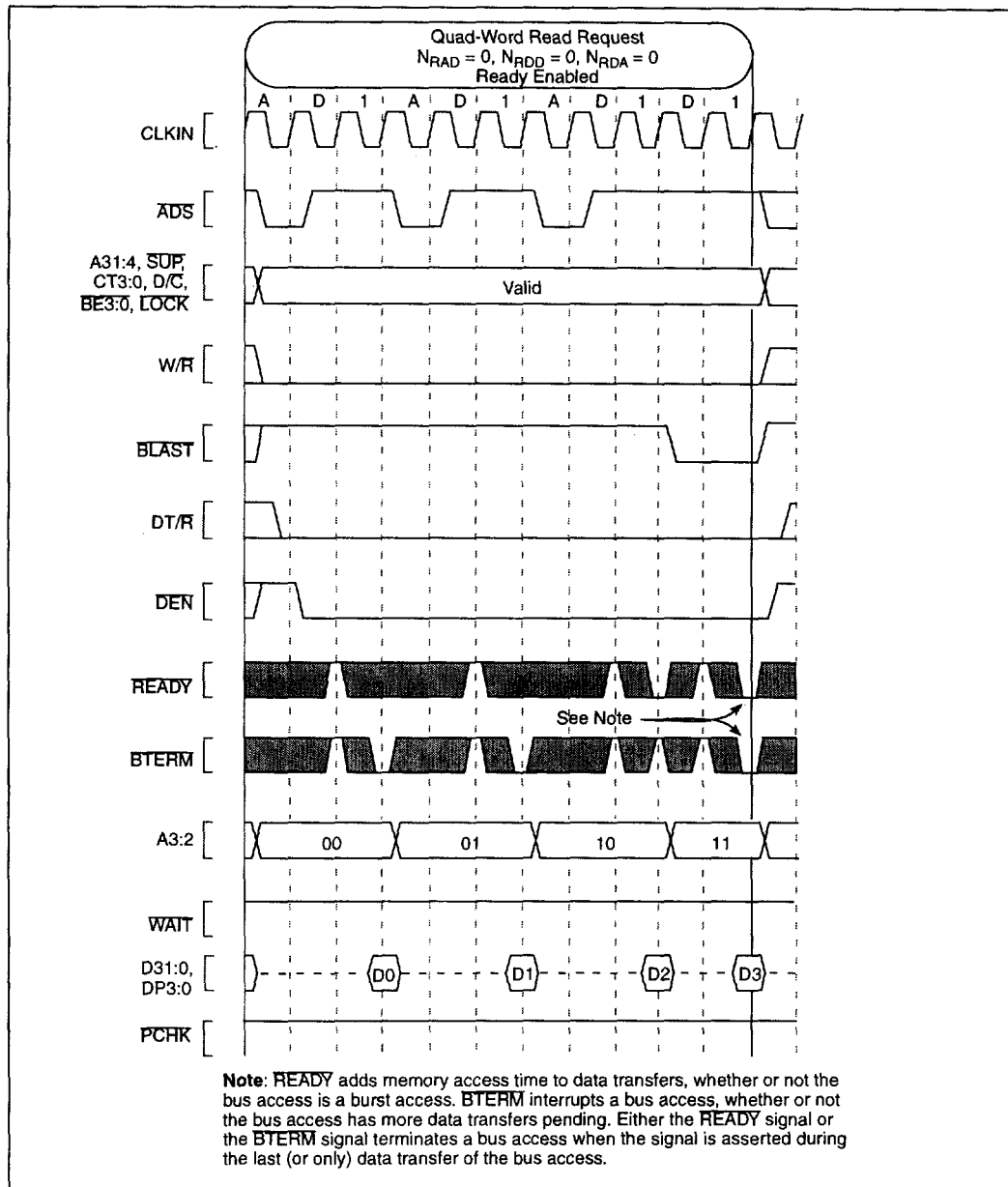
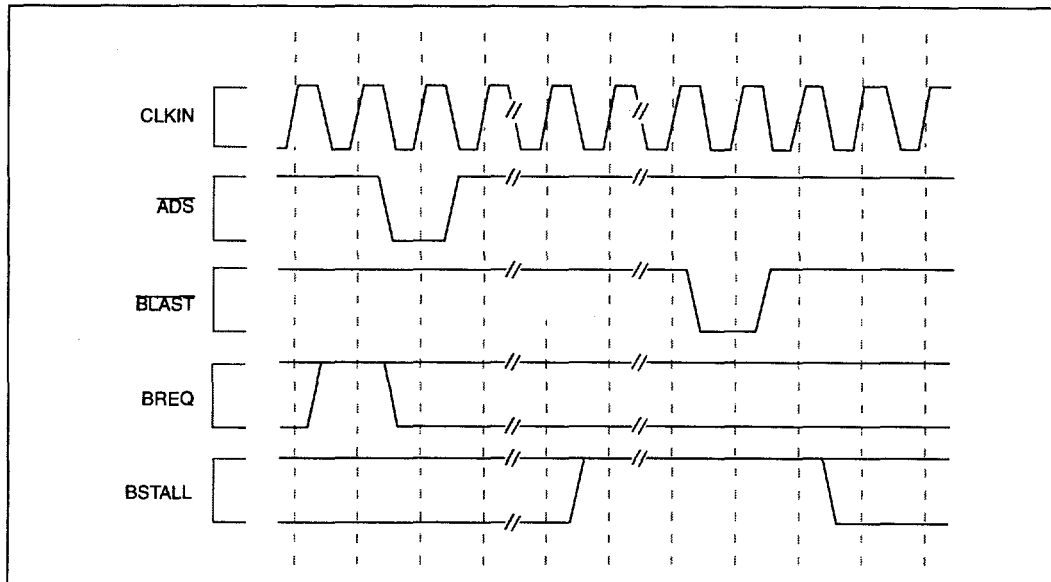


Figure 49. BREQ and BSTALL Operation



The processor can stall (BSTALL asserted) even with an empty bus queue (BREQ deasserted). Depending on the instruction stream and memory wait states, the two signals can be separated by several CLKIN cycles.

Bus arbitration logic that logically “ANDs” BSTALL and BREQ will not correctly grant the bus to the processor in all stall cases, potentially degrading processor performance.

Do not logically “AND” BSTALL and BREQ together in arbitration logic. Instead, the simplest bus arbitration should logically “OR” BSTALL and BREQ to determine the processor’s bus ownership requirements.

More sophisticated arbitration should recognize the priority nature of these two signals. Using a traffic light analogy, BREQ is a “yellow light” warning of a possible processor stall and BSTALL is a “red light” indicating a stall in progress.

Figure 50. **BOFF** Functional Timing. **BOFF** occurs during a burst or non-burst data cycle.

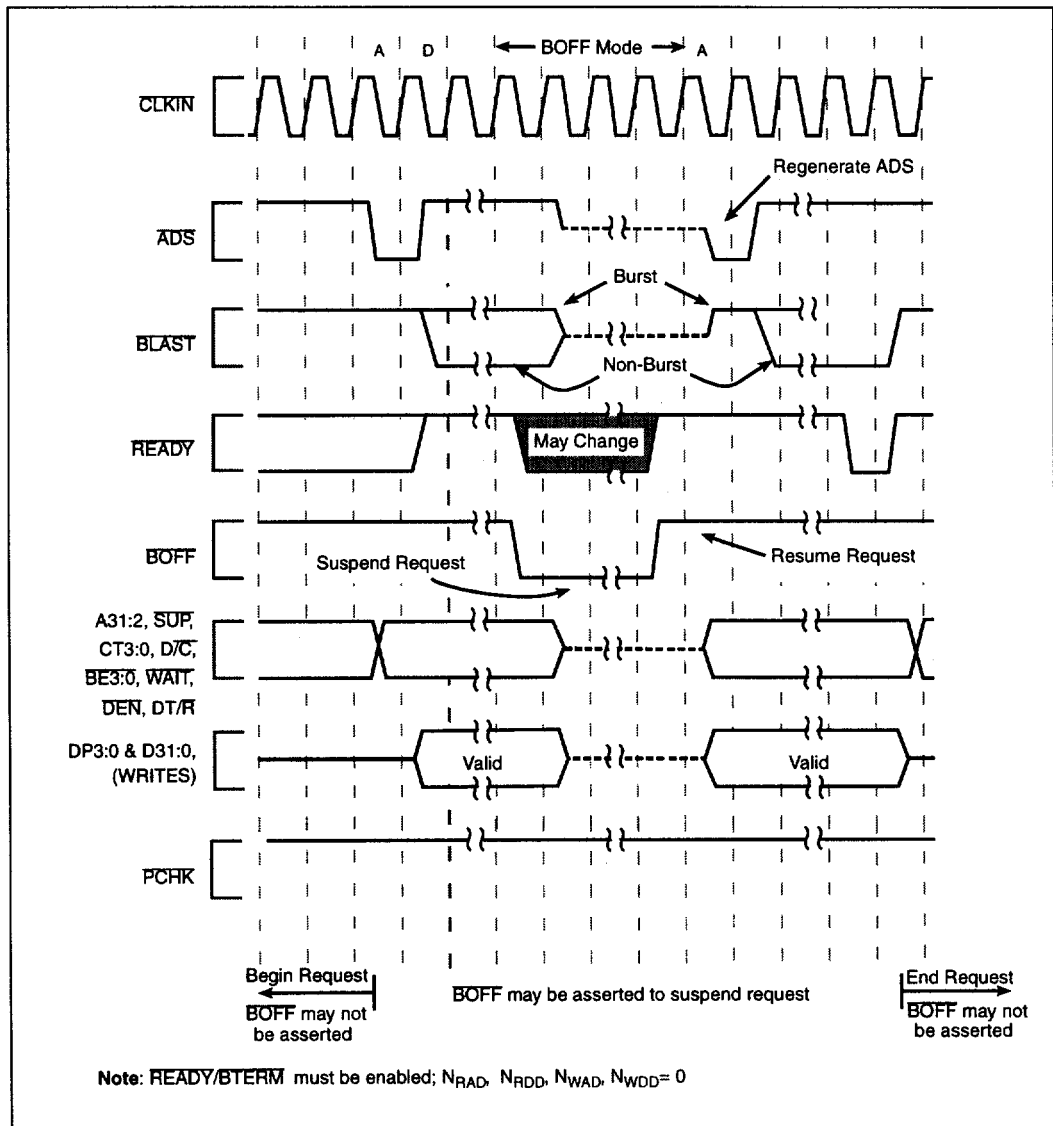
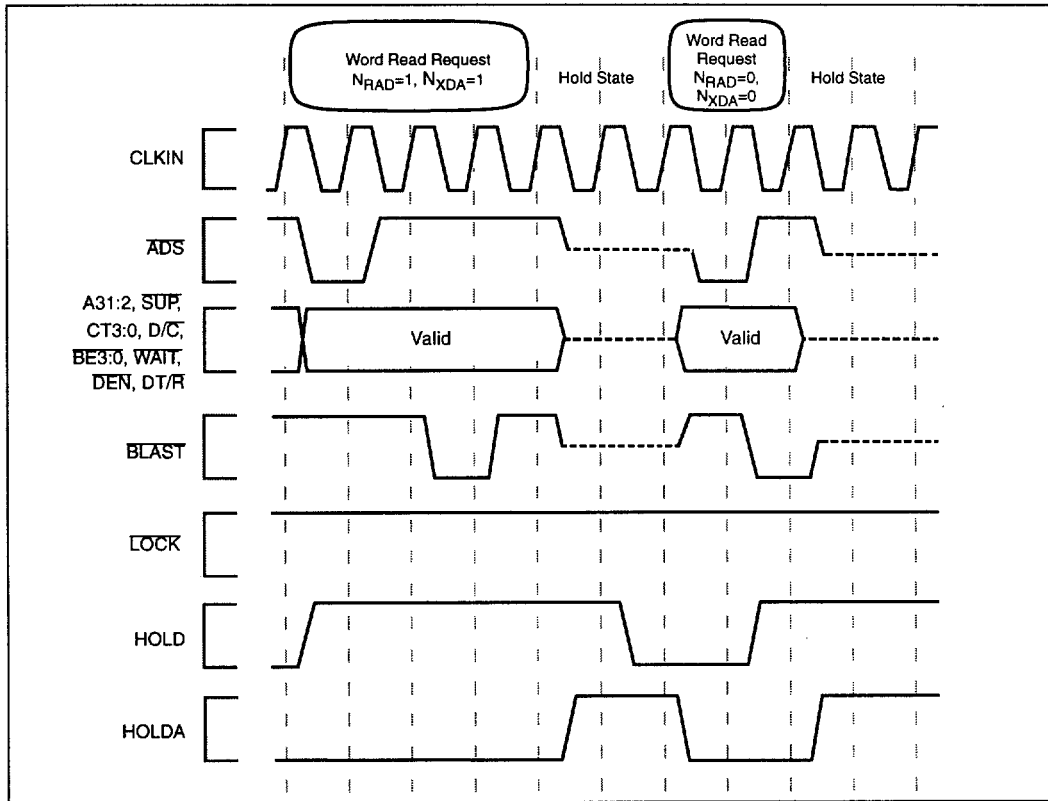
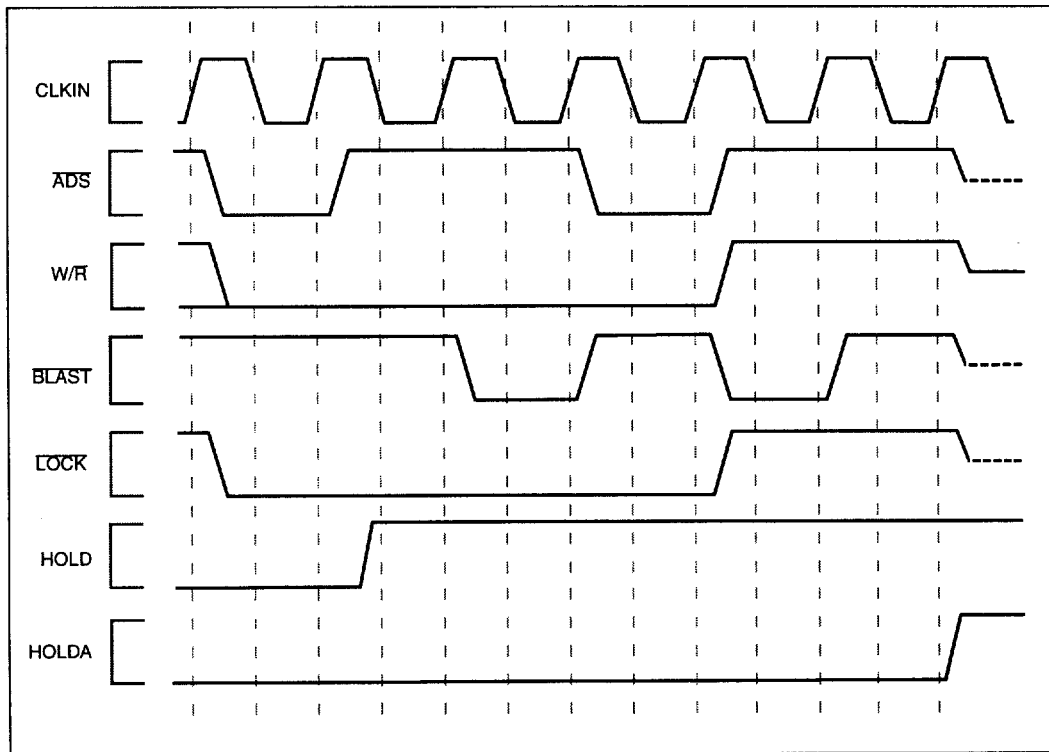


Figure 51. HOLD Functional Timing



**Figure 52. LOCK Delays HOLDA Timing**



**Figure 53. FAIL Functional Timing**

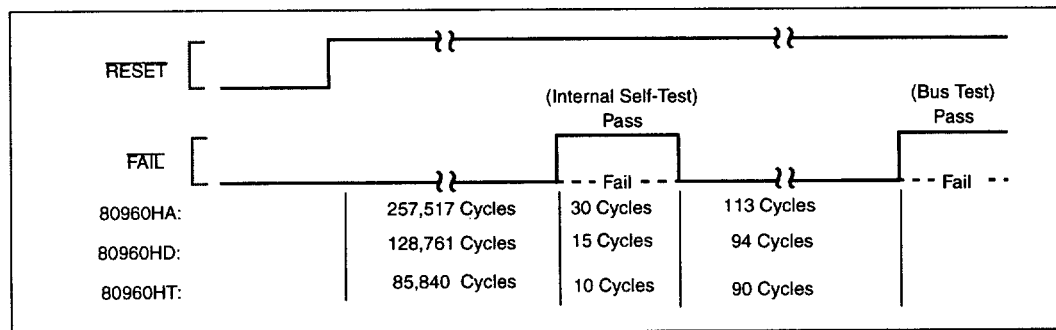


Figure 54. A Summary of Aligned and Unaligned Transfers for 32-Bit Regions

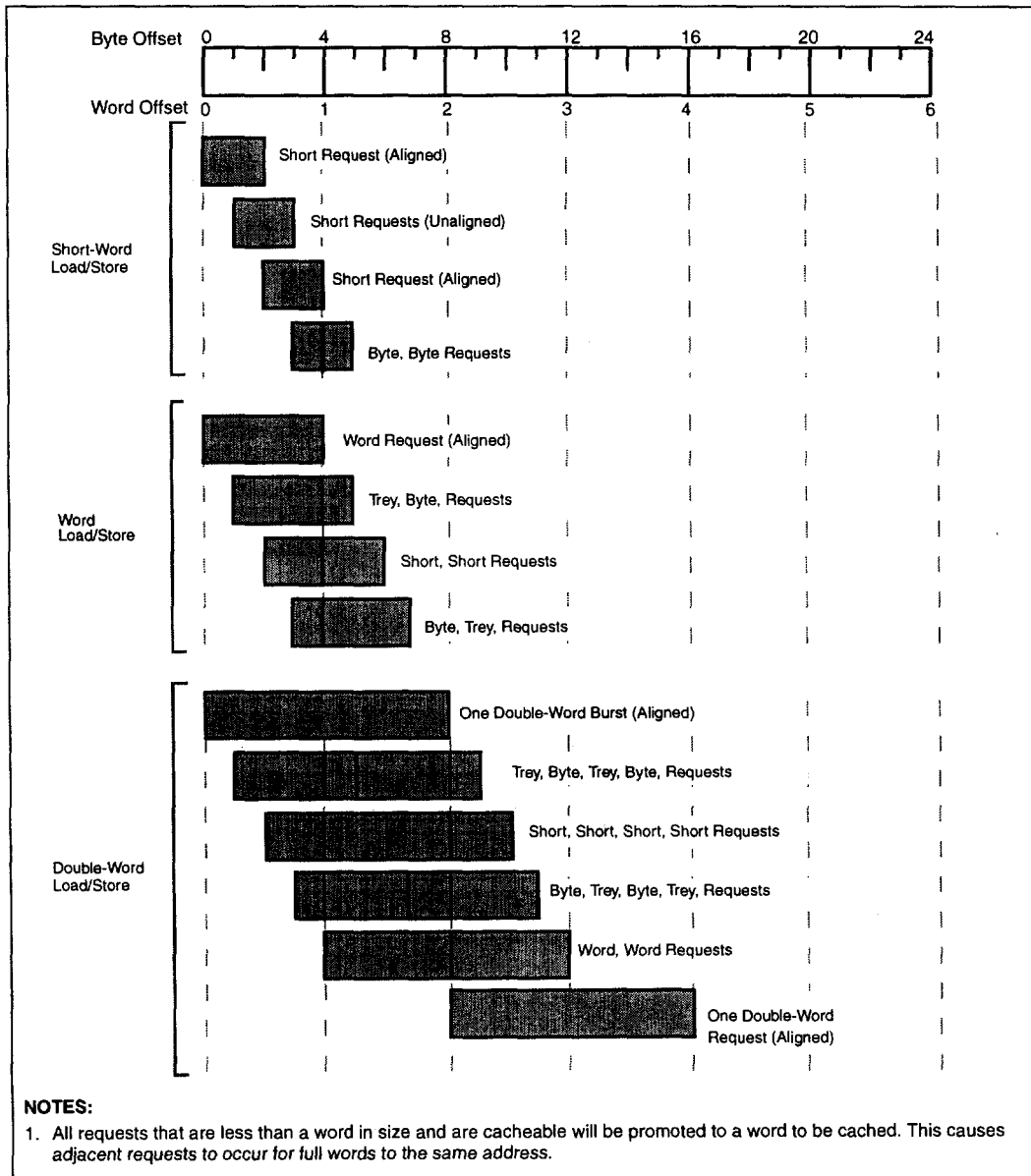


Figure 55. A Summary of Aligned and Unaligned Transfers for 32-Bit Regions (Continued)

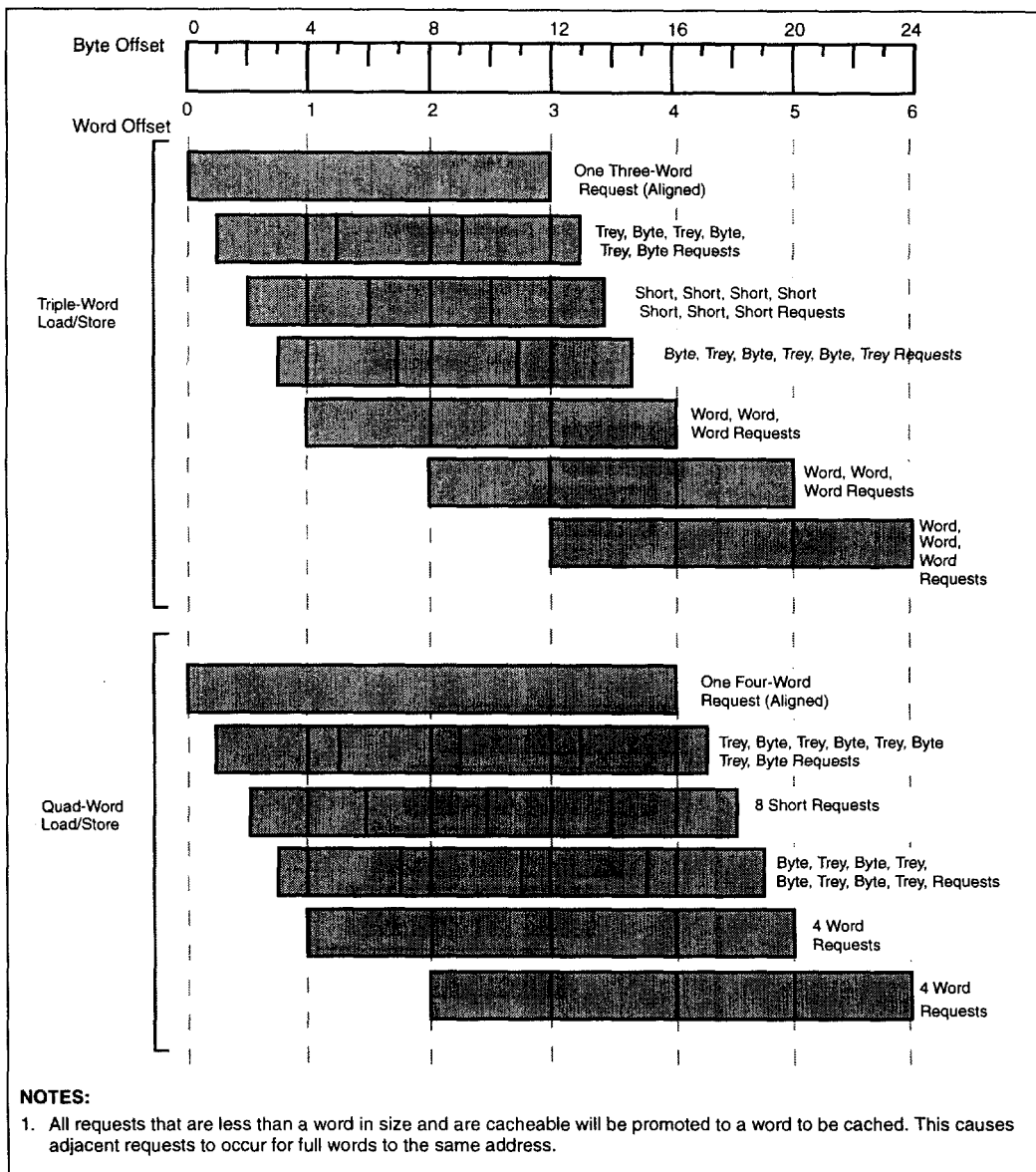




Figure 56. A Summary of Aligned and Unaligned Transfers for 16-Bit Bus

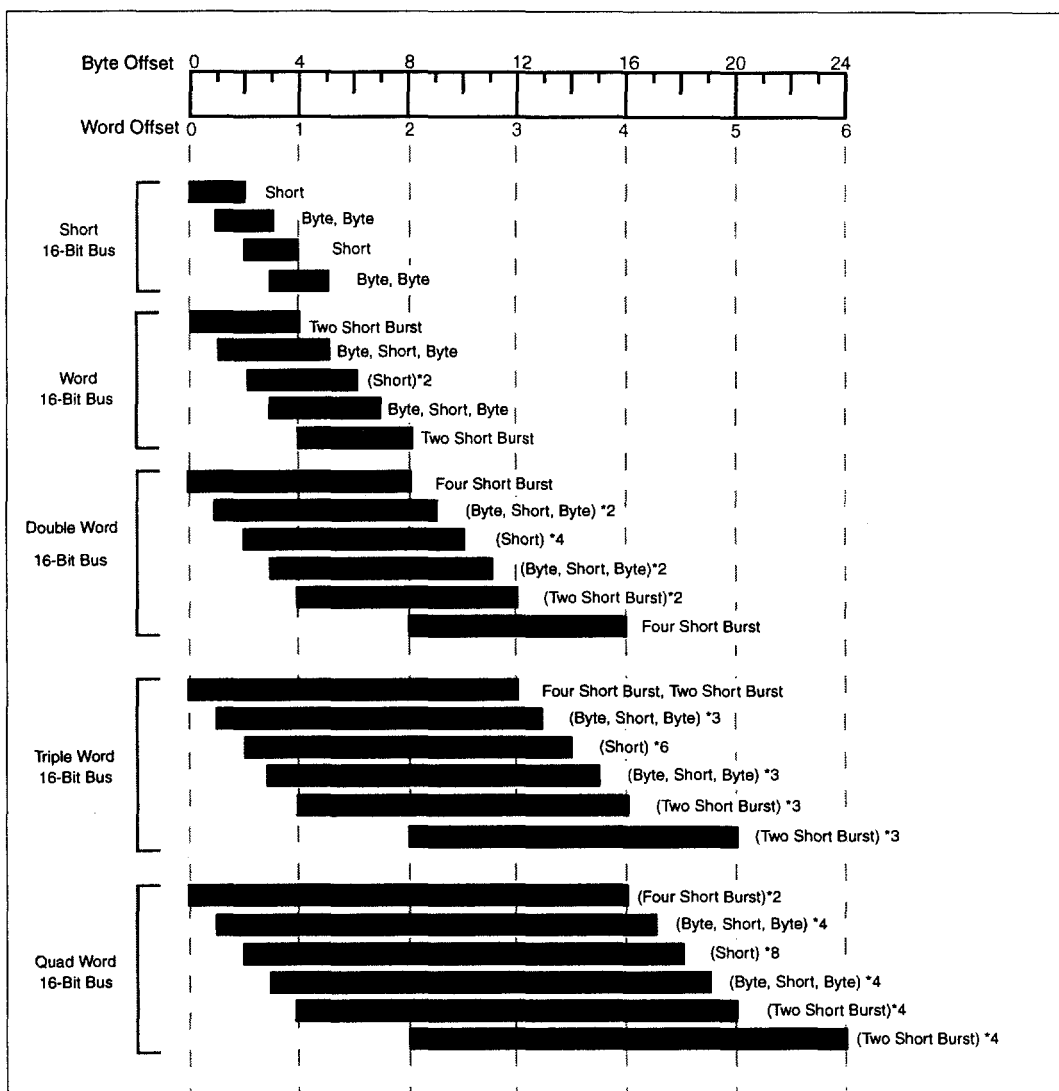


Figure 57. A Summary of Aligned and Unaligned Transfers for 8-Bit Bus

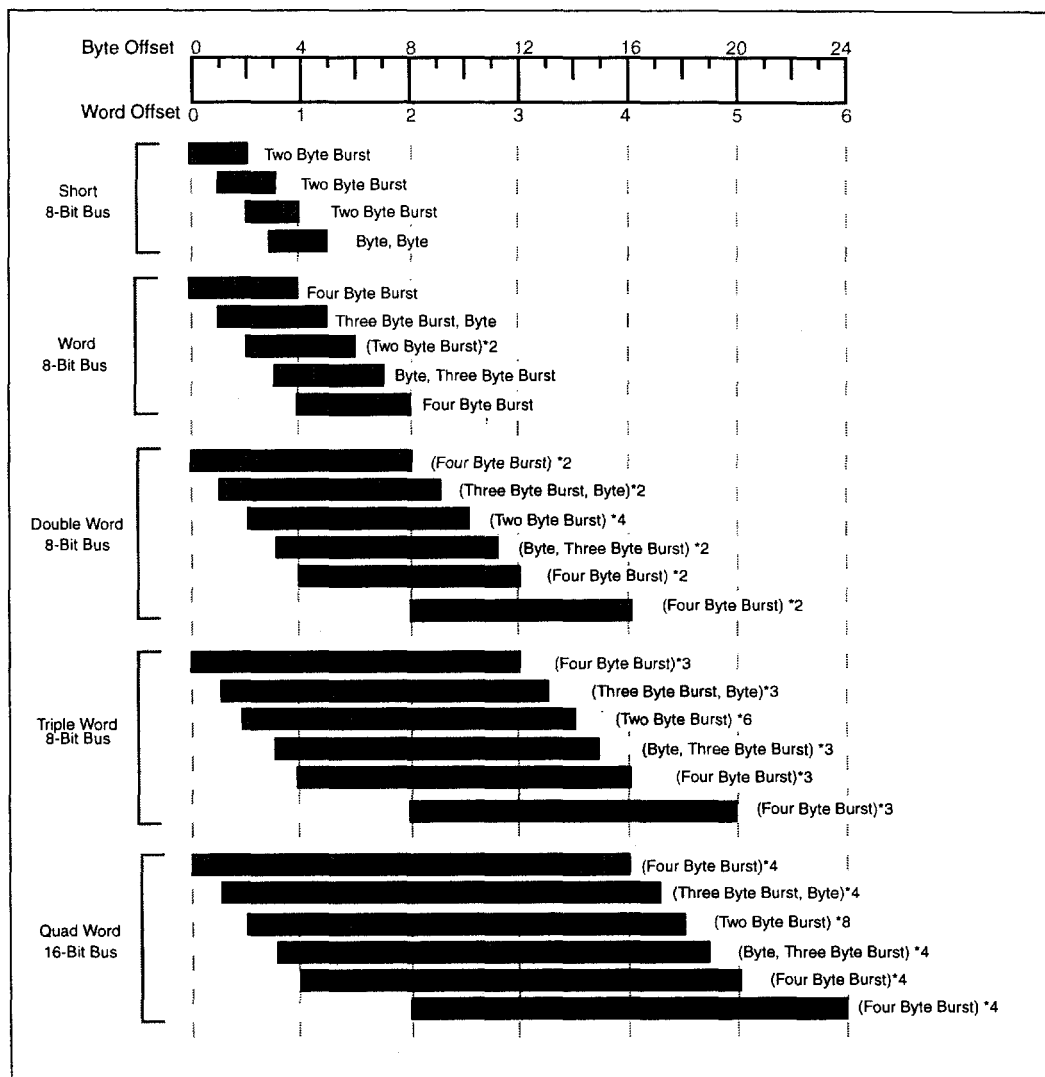


Figure 58. Idle Bus Operation

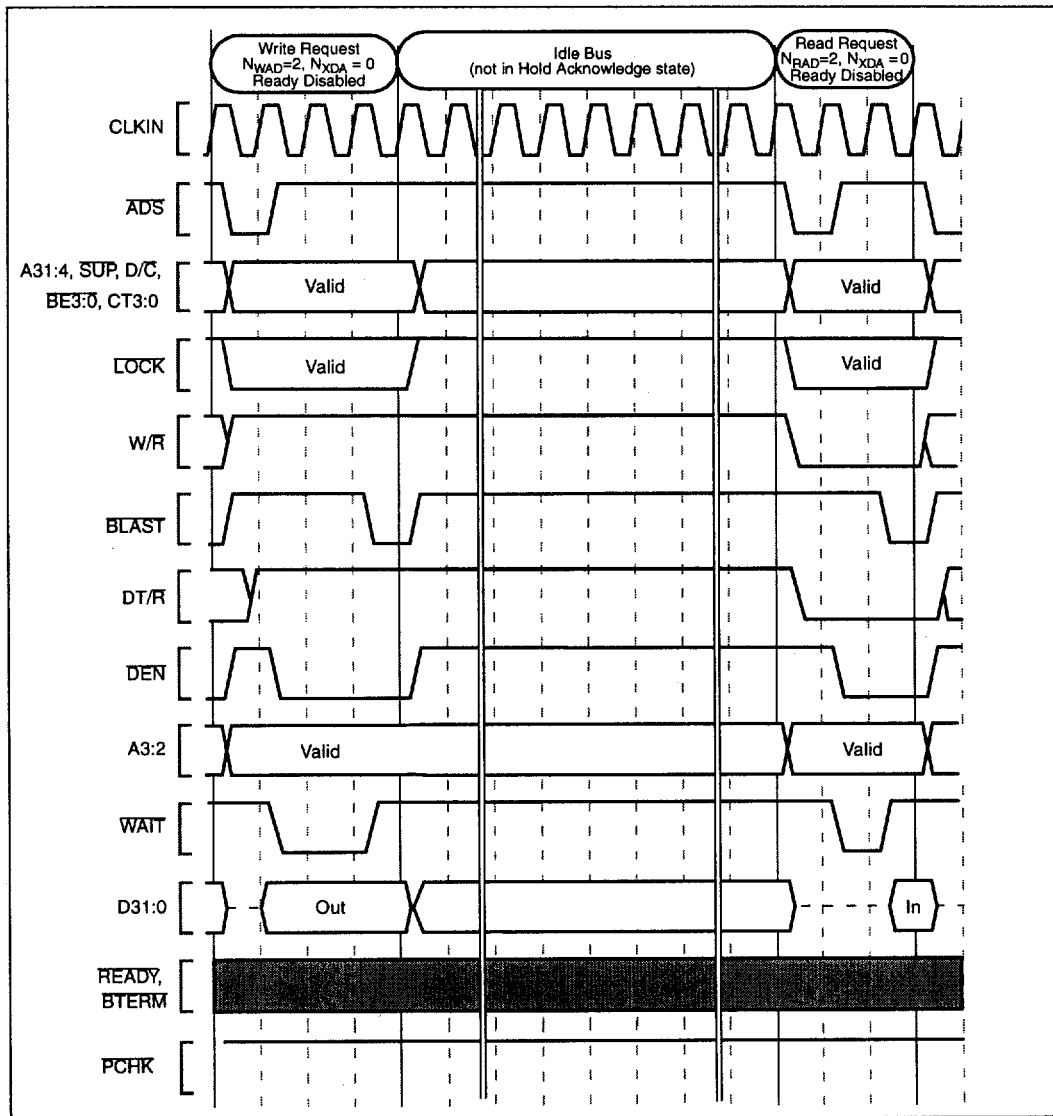
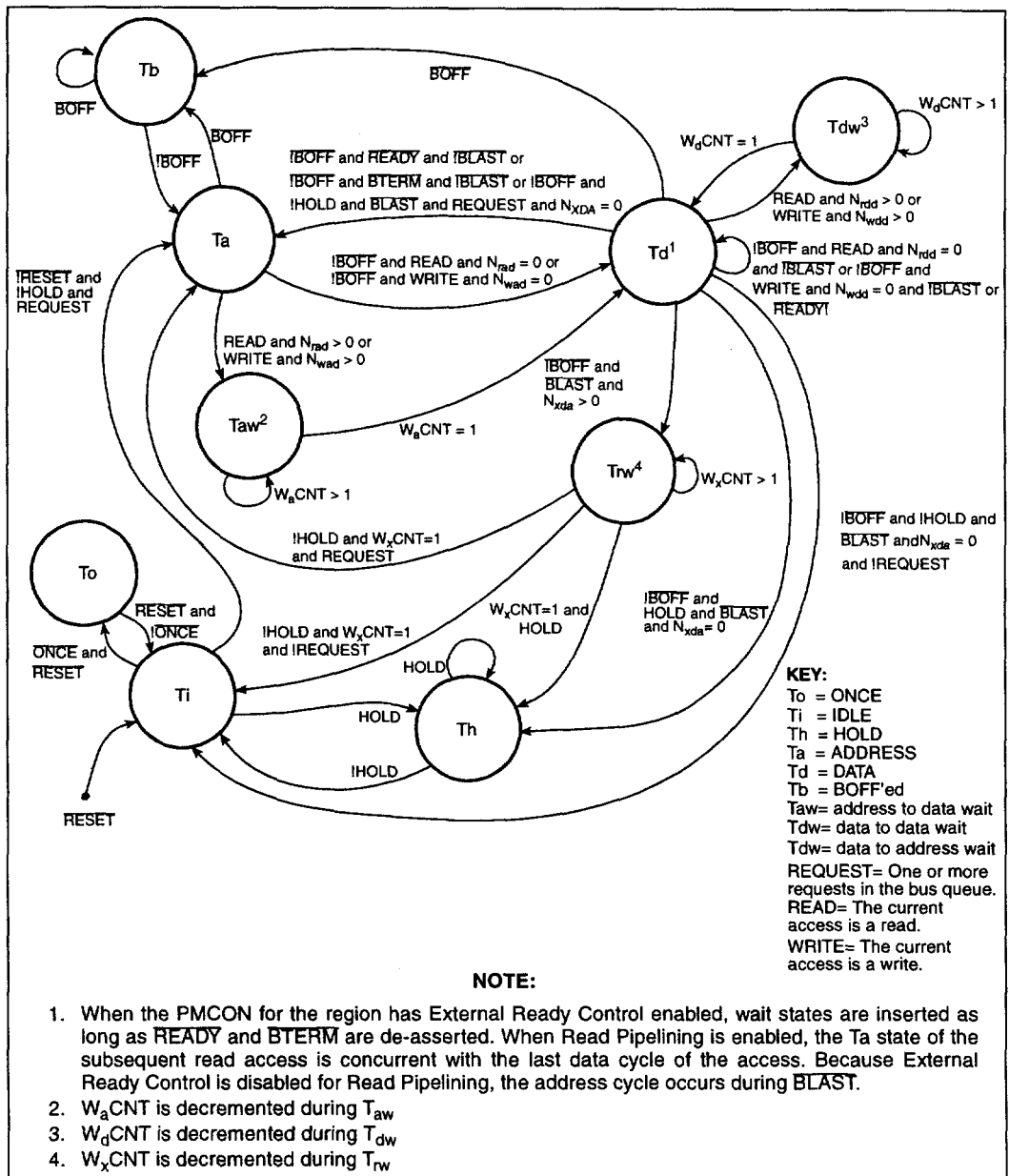




Figure 59. Bus States



## 5.1 80960Hx Boundary Scan Chain

**Table 25. 80960Hx Boundary Scan Chain (Sheet 1 of 4)**

#	BOUNDARY SCAN CELL	CELL TYPE	COMMENT
	DP3	Bidirectional	
	DP2	Bidirectional	
	DP0	Bidirectional	
	DP1	Bidirectional	
	STEST	Input	
	FAILBAR	Output	
	Enable for FAILBAR, BSTALL and BREQ	Control	
	ONCEBAR	Input	
	BOFFBAR	Input	
	D0	Bidirectional	
	D1	Bidirectional	
	D2	Bidirectional	
	D3	Bidirectional	
	D4	Bidirectional	
	D5	Bidirectional	
	D6	Bidirectional	
	D7	Bidirectional	
	Enable for DP(3:0) and D(31:0)	Control	
	D8	Bidirectional	
	D9	Bidirectional	
	D10	Bidirectional	
	D11	Bidirectional	
	D12	Bidirectional	
	D13	Bidirectional	
	D14	Bidirectional	
	D15	Bidirectional	
	D16	Bidirectional	
	D17	Bidirectional	
	D18	Bidirectional	
	D19	Bidirectional	
	D20	Bidirectional	

**NOTES:**

1. Cell#1 connects to TDO and cell #112 connects to TDI.
2. All outputs are three-state.
3. In output and bidirectional signals, a logical "1" on the enable signal enables the output. A logical "0" three-states the output.

Table 25. 80960Hx Boundary Scan Chain (Sheet 2 of 4)

#	BOUNDARY SCAN CELL	CELL TYPE	COMMENT
	D21	Bidirectional	
	D22	Bidirectional	
	D23	Bidirectional	
	D24	Bidirectional	
	D25	Bidirectional	
	D26	Bidirectional	
	D27	Bidirectional	
	D28	Bidirectional	
	D29	Bidirectional	
	D30	Bidirectional	
	D31	Bidirectional	
	BTERMBAR	Input	
	RDYBAR	Input	Appears as READYBAR in BSDL file.
	HOLD	Input	
	HOLDA	Output	
	Enable for HOLDA control	Control	
	ADSBAR	Output	
	BE3BAR	Output	Appears as BEBAR(3:0) in BSDL file.
	BE2BAR	Output	
	BE1BAR	Output	
	BE0BAR	Output	
	BLASTBAR	Output	
	DENBAR	Output	
	WRRDBAR	Output	Appears as WRBAR in BSDL file.
	DTRBAR	Output	
	Enable for DTRBAR	Control	
	WAITBAR	Output	
	BSTALL	Output	
	DATAODBAR	Output	Appears as DCBAR in BSDL file.
	USERSUPBAR	Output	Appears as SUPBAR in BSDL file.
	Enable for ADSBAR, BEBAR, BLASTBAR, DENBAR, WRRDBAR, WAITBAR, DCBAR, SUPBAR and LOCKBAR,	Control	

**NOTES:**

1. Cell#1 connects to TDO and cell #112 connects to TDI.
2. All outputs are three-state.
3. In output and bidirectional signals, a logical "1" on the enable signal enables the output. A logical "0" three-states the output.

Table 25. 80960Hx Boundary Scan Chain (Sheet 3 of 4)

#	BOUNDARY SCAN CELL	CELL TYPE	COMMENT
	LOCKBAR	Output	
	BREQ	Output	
	A31	Output	
	A30	Output	
	A29	Output	
	A28	Output	
	A27	Output	
	A26	Output	
	A25	Output	
	A24	Output	
	A23	Output	
	A22	Output	
	A21	Output	
	A20	Output	
	A19	Output	
	A18	Output	
	A17	Output	
	A16	Output	
	Enable for A(31:0) and CT(3:0)	Control	
	A15	Output	
	A14	Output	
	A13	Output	
	A12	Output	
	A11	Output	
	A10	Output	
	A9	Output	
	A8	Output	
	A7	Output	
	A6	Output	
	A5	Output	
	A4	Output	
	A3	Output	
	A2	Output	
	NMIBAR	Input	

**NOTES:**

1. Cell#1 connects to TDO and cell #112 connects to TDI.
2. All outputs are three-state.
3. In output and bidirectional signals, a logical "1" on the enable signal enables the output. A logical "0" three-states the output.

Table 25. 80960Hx Boundary Scan Chain (Sheet 4 of 4)

#	BOUNDARY SCAN CELL	CELL TYPE	COMMENT
	XINT7BAR	Input	Appears as XINTBAR(7:0) in BSDL file.
	XINT6BAR	Input	
	XINT5BAR	Input	
	XINT4BAR	Input	
	XINT3BAR	Input	
	XINT2BAR	Input	
	XINT1BAR	Input	
	XINT0BAR	Input	
	RESETBAR	Input	
	CLKIN	Input	
	CT3	Output	Appears as CT(3:0) in BSDL file.
	CT2	Output	
	CT1	Output	
	CT0	Output	
	PCHK	Output	Appears as PCHKBAR in BSDL file.
	PCHK enable	Control	

**NOTES:**

1. Cell#1 connects to TDO and cell #112 connects to TDI.
2. All outputs are three-state.
3. In output and bidirectional signals, a logical "1" on the enable signal enables the output. A logical "0" three-states the output.



## 5.2 Boundary Scan Description Language Example

Boundary-Scan Description Language (BSDL) example 14-2 meets the de facto standard means of describing essential features of ANSI/IEEE 1149.1-1993 compliant devices.

### Example 1. Boundary-Scan Description Language (BSDL) for PGA Package Example (Sheet 1 of 8)

```
-- Copyright Intel Corp. 1995

- - *****

- - Intel Corporation makes no warranty for the use of its products and assumes no
responsibility for any errors which may appear in this document nor does it make
a commitment to update the information contained herein.

- - *****
.
- - Boundary-Scan Description Language (BSDL Version 0.0) is a de-facto standard
means of describing essential features of ANSI/IEEE 1149.1-1990 compliant
devices. This language is under consideration by the IEEE for formal inclusion
within a supplement to the 1149.1-1990 standard. The generation of the supplement
entails an extensive IEEE review and a formal acceptance balloting procedure
which may change the resultant form of the language. Be aware that this process
may extend well into 1993, and at this time the IEEE does not endorse or hold an
opinion on the language.

- - *****

--

-- i960(R) Processor BSDL Model
```

**Example 1. Boundary-Scan Description Language (BSDL) for PGA Package Example (Sheet 2 of 8)**

```

-- Project code HA
-- File **NOT** verified electrically
-----
-- Rev 0.7    18 Dec 1995 Updated for A-1 stepping.
-- Rev 0.6    08 Dec 1994
-- Rev 0.5    21 Nov 1994
-- Rev 0.4    31 Oct 1994
-- Rev 0.3    26 July 1994
-- Rev 0.2    22 June 1994
-- Rev 0.1    16 Mar 1994
-- Rev 0.0    30 Aug 1993
entity Ha_Processor is
    generic (PHYSICAL_PIN_MAP : string:= "PGA");

    port (A          : out    bit_vector(2 to 31);
          ADSBAR    : out    bit;
          BEBAR     : out    bit_vector(0 to 3);
          BLASTBAR  : out    bit;
          BOFFBAR   : in     bit;
          BREQ      : out    bit;
          BSTALL    : out    bit;
          BTERMBAR  : in     bit;
          CT        : out    bit_vector(0 to 3);
          CLKIN     : in     bit;
          D         : inout  bit_vector(0 to 31);
          DENBAR    : out    bit;
          DP        : inout  bit_vector(0 to 3);
          DTRBAR    : out    bit;
          DCBAR     : out    bit;
          FAILBAR   : out    bit;
          HOLD      : in     bit;
          HOLDA     : out    bit;
          LOCKBAR   : out    bit;
          NMIBAR    : in     bit;
          ONCEBAR   : in     bit;
          PCHKBAR   : out    bit;
          READYBAR  : in     bit;
          RESETBAR  : in     bit;
          STEST     : in     bit;

```

**Example 1. Boundary-Scan Description Language (BSDL) for PGA Package Example (Sheet 3 of 8)**

```

SUPBAR      : out    bit;
TCK         : in     bit;
TDI         : in     bit;
TDO         : out    bit;
TMS         : in     bit;
TRST        : in     bit;
WAITBAR     : out    bit;
WRBAR       : out    bit;
XINTBAR     : in     bit_vector(0 to 7);
FIVEVREF    : linkage bit;
VCCPLL      : linkage bit;
VOLTDET     : out    bit;
VCC1        : linkage bit_vector(0 to 23);
VCC2        : linkage bit_vector(0 to 20);
VSS1        : linkage bit_vector(0 to 25);
VSS2        : linkage bit_vector(0 to 22);
NC          : linkage bit_vector(0 to 4)

);

use STD_1149_1_1990.all;
use i960ha_a.all;

attribute PIN_MAP of Ha_Processor : entity is PHYSICAL_PIN_MAP;
constant PGA:PIN_MAP_STRING :=
    "A          : (D16, D17, E16, E17, F17, G16, G17, H17, J17,"&
    "          K17, L17, L16, M17, N17, N16, P17, Q17, P16,"&
    "          P15, Q16, R17, R16, Q15, S17, R15, S16, Q14, "&
    "          R14, Q13, S15),
    "ADSBAR     : R06,"&
    "BEBAR      : (R09, S07, S06, S05),"&
    "BLASTBAR   : S08,"&
    "BOFFBAR    : B01,"&
    "BREQ       : R13,"&
    "BSTALL     : R12,"&
    "BTERMBAR   : R04,"&
    "CT         : (A11, A12, A13, A14),"&
    "CLKIN      : C13,"&

```

**Example 1. Boundary-Scan Description Language (BSDL) for PGA Package Example (Sheet 4 of 8)**

```

"D          : (E03, C02, D02, C01, E02, D01, F02, E01, F01,"&
"          G01, H02, H01, J01, K01, L02, L01, M01, N01,"&
"          N02, P01, P02, Q01, P03, Q02, R01, S01, Q03,"&
"          R02, Q04, S02, Q05, R03),"&
"DENBAR    : S09,"&
"DP        : (A03, B03, A04, B04),"&
"DTRBAR    : S11,"&
"DCBAR     : S13,"&
"FAILBAR   : A02,"&
"HOLD      : R05,"&
"HOLDA     : S04,"&
"LOCKBAR   : S14,"&
"NMIBAR    : D15,"&
"ONCEBAR   : C03,"&
"PCHKBAR   : B08,"&
"READYBAR  : S03,"&
"RESETBAR  : A16,"&
"STEST     : B02,"&
"SUPBAR    : Q12,"&
"TCK       : B05,"&
"TDI       : A07,"&
"TDO       : A08,"&
"TMS       : B06,"&
"TRST      : A06,"&
"WAITBAR   : S12,"&
"WRBAR     : S10,"&
" XINTBAR  : (B15, A15, A17, B16, C15, B17, C16, C17),"&
"FIVEVREF  : C05,"&
"VOLTDET   : A05,"&
"VCCPLL    : B10,"&
" VCC1     : (M02, K02, J02, G02, N03, F03, C06, B07, B09, B11,"&
"          B12, C14, E15, F16, H16, J16, K16, M16, N15, Q06,"&
"          R07, R08, R10, R11),"&
" VSS1     : (G03, H03, J03, K03, L03, M03, C07, C08, C09, C10,"&
"          C11, C12, Q07, Q08, Q09, Q10, Q11, F15, G15, H15,"&
"          J15, K15, L15, M15, A01, C04),"&
"NC        : (A09, A10, B13, B14, D03)";

```

**Example 1. Boundary-Scan Description Language (BSDL) for PGA Package Example (Sheet 5 of 8)**

```

attribute Tap_Scan_In of TDI : signal is true;
attribute Tap_Scan_Mode of TMS : signal is true;
attribute Tap_Scan_Out of TDO : signal is true;
attribute Tap_Scan_Reset of TRST : signal is true;
attribute Tap_Scan_Clock of TCK : signal is (66.0e6, BOTH);

attribute Instruction_Length of Ha_Processor: entity is 4;

attribute Instruction_Opcode of Ha_Processor: entity is

    "BYPASS (1111)," &
    "EXTEST (0000)," &
    "SAMPLE (0001)," &
    "IDCODE (0010)," &
    "RUBIST (0111)," &
    "CLAMP (0100)," &
    "HIGHZ (1000)," &
    "Reserved (1011, 1100)";

attribute Instruction_Capture of Ha_Processor: entity is "0001";

attribute Instruction_Private of Ha_Processor: entity is "Reserved" ;

attribute Idcode_Register of Ha_Processor: entity is
    "0010" & --version,
    "1000100001000000" & --part number
    "00000001001" & --manufacturers identity
    "1"; --required by the standard

attribute Register_Access of Ha_Processor: entity is
    "Runbist[32] (RUBIST)," &
    "Bypass (CLAMP, HIGHZ)";

{*****}
{ The first cell, cell 0, is closest to TDO }
{ BC_1:Control, Output3 CBSC_1:Bidir BC_4: Input, Clock }
{*****}

```

**Example 1. Boundary-Scan Description Language (BSDL) for PGA Package Example (Sheet 6 of 8)**

```

attribute Boundary_Cells of Ha_Processor: entity is "BC_4, BC_1, CBSC_1";
attribute Boundary_Length of Ha_Processor: entity is 112;
attribute Boundary_Register of Ha_Processor: entity is

    "0 (CBSC_1, DP(3),      bidir, X, 17, 1, Z)," &
    "1 (CBSC_1, DP(2),      bidir, X, 17, 1, Z)," &
    "2 (CBSC_1, DP(0),      bidir, X, 17, 1, Z)," &
    "3 (CBSC_1, DP(1),      bidir, X, 17, 1, Z)," &
    "4 (BC_4,  STEST,       input, X)," &
    "5 (BC_1,  FAILBAR,     output3, X, 6, 1, Z)," &
    "6 (BC_1,  *,          control, 1)," &
    "7 (BC_4,  ONCEBAR,     input, X)," &
    "8 (BC_4,  BOFFBAR,     input, X)," &
    "9 (CBSC_1, D(0),      bidir, X, 17, 1, Z)," &
    "10 (CBSC_1, D(1),     bidir, X, 17, 1, Z)," &
    "11 (CBSC_1, D(2),     bidir, X, 17, 1, Z)," &
    "12 (CBSC_1, D(3),     bidir, X, 17, 1, Z)," &
    "13 (CBSC_1, D(4),     bidir, X, 17, 1, Z)," &
    "14 (CBSC_1, D(5),     bidir, X, 17, 1, Z)," &
    "15 (CBSC_1, D(6),     bidir, X, 17, 1, Z)," &
    "16 (CBSC_1, D(7),     bidir, X, 17, 1, Z)," &
    "17 (BC_1,  *,          control, 1)," &
    "18 (CBSC_1, D(8),     bidir, X, 17, 1, Z)," &
    "19 (CBSC_1, D(9),     bidir, X, 17, 1, Z)," &
    "20 (CBSC_1, D(10),    bidir, X, 17, 1, Z)," &
    "21 (CBSC_1, D(11),    bidir, X, 17, 1, Z)," &
    "22 (CBSC_1, D(12),    bidir, X, 17, 1, Z)," &
    "23 (CBSC_1, D(13),    bidir, X, 17, 1, Z)," &
    "24 (CBSC_1, D(14),    bidir, X, 17, 1, Z)," &
    "25 (CBSC_1, D(15),    bidir, X, 17, 1, Z)," &
    "26 (CBSC_1, D(16),    bidir, X, 17, 1, Z)," &
    "27 (CBSC_1, D(17),    bidir, X, 17, 1, Z)," &
    "28 (CBSC_1, D(18),    bidir, X, 17, 1, Z)," &
    "29 (CBSC_1, D(19),    bidir, X, 17, 1, Z)," &
    "30 (CBSC_1, D(20),    bidir, X, 17, 1, Z)," &
    "31 (CBSC_1, D(21),    bidir, X, 17, 1, Z)," &
    "32 (CBSC_1, D(22),    bidir, X, 17, 1, Z)," &
    "33 (CBSC_1, D(23),    bidir, X, 17, 1, Z)," &
    "34 (CBSC_1, D(24),    bidir, X, 17, 1, Z)," &

```

**Example 1. Boundary-Scan Description Language (BSDL) for PGA Package Example (Sheet 7 of 8)**

```

"35 (CBSC_1, D(25),      bidir,  X, 17, 1, Z)," &
"36 (CBSC_1, D(26),      bidir,  X, 17, 1, Z)," &
"37 (CBSC_1, D(27),      bidir,  X, 17, 1, Z)," &
"38 (CBSC_1, D(28),      bidir,  X, 17, 1, Z)," &
"39 (CBSC_1, D(29),      bidir,  X, 17, 1, Z)," &
"40 (CBSC_1, D(30),      bidir,  X, 17, 1, Z)," &
"41 (CBSC_1, D(31),      bidir,  X, 17, 1, Z)," &
"42 (BC_4,  BTERMBAR,    input,  X)," &
"43 (BC_4,  READYBAR,    input,  X)," &
"44 (BC_4,  HOLD,        input,  X)," &
"45 (BC_1,  HOLDA,       output3, X, 46, 1, Z)," &
"46 (BC_1,  *,           control, 1)," &
"47 (BC_1,  ADSBAR,      output3, X, 61, 1, Z)," &
"48 (BC_1,  BEBAR(3),    output3, X, 61, 1, Z)," &
"49 (BC_1,  BEBAR(2),    output3, X, 61, 1, Z)," &
"50 (BC_1,  BEBAR(1),    output3, X, 61, 1, Z)," &
"51 (BC_1,  BEBAR(0),    output3, X, 61, 1, Z)," &
"52 (BC_1,  BLASTBAR,    output3, X, 61, 1, Z)," &
"53 (BC_1,  DENBAR,      output3, X, 61, 1, Z)," &
"54 (BC_1,  WRBAR,       output3, X, 61, 1, Z)," &
"55 (BC_1,  DTRBAR,      output3, X, 56, 1, Z)," &
"56 (BC_1,  *,           control, 1)," &
"57 (BC_1,  WAITBAR,     output3, X, 61, 1, Z)," &
"58 (BC_1,  BSTALL,      output3, X, 6, 1, Z)," &
"59 (BC_1,  DCBAR,       output3, X, 61, 1, Z)," &
"60 (BC_1,  SUPBAR,      output3, X, 61, 1, Z)," &
"61 (BC_1,  *,           control, 1)," &
"62 (BC_1,  LOCKBAR,     output3, X, 61, 1, Z)," &
"63 (BC_1,  BREQ,        output3, X, 6, 1, Z)," &
"64 (BC_1,  A(31),       output3, X, 80, 1, Z)," &
"65 (BC_1,  A(30),       output3, X, 80, 1, Z)," &
"66 (BC_1,  A(29),       output3, X, 80, 1, Z)," &
"67 (BC_1,  A(28),       output3, X, 80, 1, Z)," &
"68 (BC_1,  A(27),       output3, X, 80, 1, Z)," &
"69 (BC_1,  A(26),       output3, X, 80, 1, Z)," &
"70 (BC_1,  A(25),       output3, X, 80, 1, Z)," &
"71 (BC_1,  A(24),       output3, X, 80, 1, Z)," &
"72 (BC_1,  A(23),       output3, X, 80, 1, Z)," &
"73 (BC_1,  A(22),       output3, X, 80, 1, Z)," &
    
```

**Example 1. Boundary-Scan Description Language (BSDL) for PGA Package Example (Sheet 8 of 8)**

```

"74 (BC_1, A(21), output3, X, 80, 1, Z)," &
"75 (BC_1, A(20), output3, X, 80, 1, Z)," &
"76 (BC_1, A(19), output3, X, 80, 1, Z)," &
"77 (BC_1, A(18), output3, X, 80, 1, Z)," &
"78 (BC_1, A(17), output3, X, 80, 1, Z)," &
"79 (BC_1, A(16), output3, X, 80, 1, Z)," &
"80 (BC_1, *, control, 1)," &
"81 (BC_1, A(15), output3, X, 80, 1, Z)," &
"82 (BC_1, A(14), output3, X, 80, 1, Z)," &
"83 (BC_1, A(13), output3, X, 80, 1, Z)," &
"84 (BC_1, A(12), output3, X, 80, 1, Z)," &
"85 (BC_1, A(11), output3, X, 80, 1, Z)," &
"86 (BC_1, A(10), output3, X, 80, 1, Z)," &
"87 (BC_1, A(9), output3, X, 80, 1, Z)," &
"88 (BC_1, A(8), output3, X, 80, 1, Z)," &
"89 (BC_1, A(7), output3, X, 80, 1, Z)," &
"90 (BC_1, A(6), output3, X, 80, 1, Z)," &
"91 (BC_1, A(5), output3, X, 80, 1, Z)," &
"92 (BC_1, A(4), output3, X, 80, 1, Z)," &
"93 (BC_1, A(3), output3, X, 80, 1, Z)," &
"94 (BC_1, A(2), output3, X, 80, 1, Z)," &
"95 (BC_4, NMIBAR, input, X)," &
"96 (BC_4, XINTBAR(7), input, X)," &
"97 (BC_4, XINTBAR(6), input, X)," &
"98 (BC_4, XINTBAR(5), input, X)," &
"99 (BC_4, XINTBAR(4), input, X)," &
"100 (BC_4, XINTBAR(3), input, X)," &
"101 (BC_4, XINTBAR(2), input, X)," &
"102 (BC_4, XINTBAR(1), input, X)," &
"103 (BC_4, XINTBAR(0), input, X)," &
"104 (BC_4, RESETBAR, input, X)," &
"105 (BC_4, CLKIN, input, X)," &
"106 (BC_1, CT(3), output3, X, 80, 1, Z)," &
"107 (BC_1, CT(2), output3, X, 80, 1, Z)," &
"108 (BC_1, CT(1), output3, X, 80, 1, Z)," &
"109 (BC_1, CT(0), output3, X, 80, 1, Z)," &
"110 (BC_1, PCHKBAR, output3, X, 111, 1, Z)," &
"111 (BC_1, *, control, 1)";
end Ha_Processor;

```



**Example 2. Boundary-Scan Description Language (BSDL) for PQ2 Package Example (Sheet 1 of 8)**

```
-- Copyright Intel Corporation 1995, 1996

-- *****

-- Intel Corporation makes no warranty for the use of its products and assumes no
responsibility for any errors which may appear in this document nor does it make
a commitment to update the information contained herein.

-- *****

-- Boundary-Scan Description Language (BSDL Version 0.0) is a de-facto

-- standard means of describing essential features of ANSI/IEEE 1149.1-1990
compliant devices. This language is under consideration by the IEEE for formal
inclusion within a supplement to the 1149.1-1990 standard. The generation of the
supplement entails an extensive IEEE review and a formal acceptance balloting
procedure which may change the resultant form of the language. Be aware that this
process may extend well into 1993, and at this time the IEEE does not endorse or
hold an opinion on the language.

-- i960(R) Processor BSDL Model
-- Project code HA
-- File **NOT** verified electrically
-----
-- Rev 0.8      4 Apr 1996  Changed for PQ2 Package
-- Rev 0.7      18 Dec 1995 Updated for A-1 stepping.
-- Rev 0.6      08 Dec 1994
-- Rev 0.5      21 Nov 1994
-- Rev 0.4      31 Oct 1994
-- Rev 0.3      26 July 1994
-- Rev 0.2      22 June 1994
-- Rev 0.1      16 Mar 1994
-- Rev 0.0      30 Aug 1993
```

**Example 2. Boundary-Scan Description Language (BSDL) for PQ2 Package Example (Sheet 2 of 8)**

```
entity Ha_Processor is
  generic (PHYSICAL_PIN_MAP : string:= "PQ2");
  port (A          : out   bit_vector(2 to 31);
        ADSBAR    : out   bit;
        BEBAR     : out   bit_vector(0 to 3);
        BLASTBAR  : out   bit;
        BOFFBAR   : in    bit;
        BREQ      : out   bit;
        BSTALL    : out   bit;
        BTERMBAR  : in    bit;
        CT        : out   bit_vector(0 to 3);
        CLKIN     : in    bit;
        D          : inout bit_vector(0 to 31);
        DENBAR    : out   bit;
        DP        : inout bit_vector(0 to 3);
        DTRBAR    : out   bit;
        DCBAR     : out   bit;
        FAILBAR   : out   bit;
        HOLD      : in    bit;
        HOLDA     : out   bit;
        LOCKBAR   : out   bit;
        NMIBAR    : in    bit;
        ONCEBAR   : in    bit;
        PCHKBAR   : out   bit;
        READYBAR  : in    bit;
        RESETBAR  : in    bit;
        STEST     : in    bit;
        SUPBAR    : out   bit;
        TCK       : in    bit;
        TDI       : in    bit;
        TDO       : out   bit;
        TMS       : in    bit;
        TRST      : in    bit;
        WAITBAR   : out   bit;
        WRBAR     : out   bit;
        XINTBAR   : in    bit_vector(0 to 7);
        FIVEVREF  : linkage bit;
        VCCPLL    : linkage bit;
```

**Example 2. Boundary-Scan Description Language (BSDL) for PQ2 Package Example (Sheet 3 of 8)**

```

VCC1      : linkage bit_vector(0 to 23);
VCC2      : linkage bit_vector(0 to 23);
VSS1      : linkage bit_vector(0 to 23);
VSS2      : linkage bit_vector(0 to 23)

);

use STD_1149_1_1990.all;
use i960ha_a.all;

attribute PIN_MAP of Ha_Processor : entity is PHYSICAL_PIN_MAP;
constant PQ2:PIN_MAP_STRING :=

"A          : (151, 150, 147, 146, 145, 144, 141, 140, 139, 138,"&
"           135, 134, 133, 132, 127, 126, 125, 124, 121, 120,"&
"           119, 118, 113, 112, 111, 110, 107, 106, 105, 104),"&
"ADSBAR    : 77,"&
"BE BAR    : (83, 82, 79, 78),"&
"BLASTBAR  : 84,"&
"BOFFBAR   : 10,"&
"BREQ      : 100,"&
"BSTALL    : 91,"&
"BTERMBAR  : 67,"&
"CT        : (183, 182, 181, 180),"&
"CLKIN     : 175,"&
"D         : (12, 13, 14, 15, 20, 21, 22, 23, 26, 27, 28, 29,"&
"           34, 35, 36, 37, 39, 40, 41, 42, 45, 50, 51, 52,"&
"           54, 55, 56, 57, 61, 62, 63, 64),"&
"DENBAR    : 85,"&
"DP        : (206, 207, 203, 202),"&
"DTRBAR    : 89,"&
"DCBAR     : 96,"&
"FAILBAR   : 5,"&
"HOLD      : 69,"&
"HOLDA     : 72,"&
"LOCKBAR   : 99,"&
"NMIBAR    : 159,"&

```

**Example 2. Boundary-Scan Description Language (BSDL) for PQ2 Package Example (Sheet 4 of 8)**

```

"ONCEBAR      : 6,"&
"PCHKBAR      : 189,"&
"READYBAR     : 68,"&
"RESETBAR     : 174,"&
"STEST        : 208,"&
"SUPBAR        : 97,"&
"TCK           : 194,"&
"TDI           : 191,"&
"TDO           : 188,"&
"TMS           : 192,"&
"TRST         : 193,"&
"WAITBAR      : 90,"&
"WRBAR        : 88,"&
"XINTBAR      : (169, 168, 167, 166, 163, 162, 161, 160),"&
"FIVEVREF     : 197,"&
"VCCPLL       : 177,"&
"VCC1         : (1, 4, 9, 11, 17, 19, 25, 31, 33, 38, 44, 46,"&
"              49, 59, 60, 66, 71, 74, 76, 81, 87, 92, 95, 101),"&
"VCC2         : (102, 109, 115, 117, 123, 128, 131, 137, 143, 149,"&
"              153, 154, 158, 165, 171, 173, 176, 179, 185, 187,"&
"              196, 199, 201, 204),"&
"VSS1         : (2, 3, 7, 8, 16, 18, 24, 30, 32, 43, 47, 48,"&
"              53, 58, 65, 70, 73, 75, 80, 86, 93, 94, 98, 103),"&
"VSS2         : (108, 114, 116, 122, 129, 130, 136, 142, 148, 152,"&
"              155, 156, 157, 164, 170, 172, 178, 184, 186, 190,"&
"              195, 198, 200, 205)";

attribute Tap_Scan_In    of TDI    : signal is true;
attribute Tap_Scan_Mode  of TMS    : signal is true;
attribute Tap_Scan_Out   of TDO    : signal is true;
attribute Tap_Scan_Reset of TRST   : signal is true;
attribute Tap_Scan_Clock of TCK    : signal is (66.0e6, BOTH);

attribute Instruction_Length of Ha_Processor: entity is 4;

attribute Instruction_Opcode of Ha_Processor: entity is

```

**Example 2. Boundary-Scan Description Language (BSDL) for PQ2 Package Example (Sheet 5 of 8)**

```

        "BYPASS      (1111)," &
        "EXTEST      (0000)," &
        "SAMPLE      (0001)," &
        "IDCODE      (0010)," &
        "RUBIST      (0111)," &
        "CLAMP      (0100)," &
        "HIGHZ      (1000)," &
        "Reserved    (1011, 1100)";

attribute Instruction_Capture of Ha_Processor: entity is "0001";

attribute Instruction_Private of Ha_Processor: entity is "Reserved" ;

attribute Idcode_Register of Ha_Processor: entity is
    "0001" & version,
    "10001000010000000" & part number
    "00000001001"& manufacturers identity
    "1";    required by the standard

attribute Register_Access of Ha_Processor: entity is
    "Runbist[32]      (RUBIST)," &
    "Bypass          (CLAMP, HIGHZ)";
*****
{ The first cell, cell 0, is closest to TDO }
{ BC_1:Control, Output3 CBSC_1:Bidir BC_4: Input, Clock }
*****

attribute Boundary_Cells of Ha_Processor: entity is "BC_4, BC_1, CBSC_1";
attribute Boundary_Length of Ha_Processor: entity is 112;
attribute Boundary_Register of Ha_Processor: entity is

    "0 (CBSC_1, DP(3),      bidir, X, 17, 1, Z)," &
    "1 (CBSC_1, DP(2),      bidir, X, 17, 1, Z)," &
    "2 (CBSC_1, DP(0),      bidir, X, 17, 1, Z)," &
    "3 (CBSC_1, DP(1),      bidir, X, 17, 1, Z)," &
    "4 (BC_4, STEST,        input, X)," &
    "5 (BC_1, FAILBAR,      output3, X, 6, 1, Z)," &
    
```

**Example 2. Boundary-Scan Description Language (BSDL) for PQ2 Package Example (Sheet 6 of 8)**

```

"6 (BC_1, *, control, 1)," &
"7 (BC_4, ONCEBAR, input, X)," &
"8 (BC_4, BOFFBAR, input, X)," &
"9 (CBSC_1, D(0), bidir, X, 17, 1, Z)," &
"10 (CBSC_1, D(1), bidir, X, 17, 1, Z)," &
"11 (CBSC_1, D(2), bidir, X, 17, 1, Z)," &
"12 (CBSC_1, D(3), bidir, X, 17, 1, Z)," &
"13 (CBSC_1, D(4), bidir, X, 17, 1, Z)," &
"14 (CBSC_1, D(5), bidir, X, 17, 1, Z)," &
"15 (CBSC_1, D(6), bidir, X, 17, 1, Z)," &
"16 (CBSC_1, D(7), bidir, X, 17, 1, Z)," &
"17 (BC_1, *, control, 1)," &
"18 (CBSC_1, D(8), bidir, X, 17, 1, Z)," &
"19 (CBSC_1, D(9), bidir, X, 17, 1, Z)," &
"20 (CBSC_1, D(10), bidir, X, 17, 1, Z)," &
"21 (CBSC_1, D(11), bidir, X, 17, 1, Z)," &
"22 (CBSC_1, D(12), bidir, X, 17, 1, Z)," &
"23 (CBSC_1, D(13), bidir, X, 17, 1, Z)," &
"24 (CBSC_1, D(14), bidir, X, 17, 1, Z)," &
"25 (CBSC_1, D(15), bidir, X, 17, 1, Z)," &
"26 (CBSC_1, D(16), bidir, X, 17, 1, Z)," &
"27 (CBSC_1, D(17), bidir, X, 17, 1, Z)," &
"28 (CBSC_1, D(18), bidir, X, 17, 1, Z)," &
"29 (CBSC_1, D(19), bidir, X, 17, 1, Z)," &
"30 (CBSC_1, D(20), bidir, X, 17, 1, Z)," &
"31 (CBSC_1, D(21), bidir, X, 17, 1, Z)," &
"32 (CBSC_1, D(22), bidir, X, 17, 1, Z)," &
"33 (CBSC_1, D(23), bidir, X, 17, 1, Z)," &
"34 (CBSC_1, D(24), bidir, X, 17, 1, Z)," &
"35 (CBSC_1, D(25), bidir, X, 17, 1, Z)," &
"36 (CBSC_1, D(26), bidir, X, 17, 1, Z)," &
"37 (CBSC_1, D(27), bidir, X, 17, 1, Z)," &
"38 (CBSC_1, D(28), bidir, X, 17, 1, Z)," &
"39 (CBSC_1, D(29), bidir, X, 17, 1, Z)," &
"40 (CBSC_1, D(30), bidir, X, 17, 1, Z)," &

```

**Example 2. Boundary-Scan Description Language (BSDL) for PQ2 Package Example (Sheet 7 of 8)**

```

"41 (CBSC_1, D(31),      bidir,   X, 17, 1, Z)," &
"42 (BC_4,  BTERMBAR,   input,   X)," &
"43 (BC_4,  READYBAR,  input,   X)," &
"44 (BC_4,  HOLD,      input,   X)," &
"45 (BC_1,  HOLDA,     output3, X, 46, 1, Z)," &
"46 (BC_1,  *,        control, 1)," &
"47 (BC_1,  ADSBAR,    output3, X, 61, 1, Z)," &
"48 (BC_1,  BEBAR(3),  output3, X, 61, 1, Z)," &
"49 (BC_1,  BEBAR(2),  output3, X, 61, 1, Z)," &
"50 (BC_1,  BEBAR(1),  output3, X, 61, 1, Z)," &
"51 (BC_1,  BEBAR(0),  output3, X, 61, 1, Z)," &
"52 (BC_1,  BLASTBAR,  output3, X, 61, 1, Z)," &
"53 (BC_1,  DENBAR,    output3, X, 61, 1, Z)," &
"54 (BC_1,  WRBAR,     output3, X, 61, 1, Z)," &
"55 (BC_1,  DTRBAR,    output3, X, 56, 1, Z)," &
"56 (BC_1,  *,        control, 1)," &
"57 (BC_1,  WAITBAR,   output3, X, 61, 1, Z)," &
"58 (BC_1,  BSTALL,    output3, X, 6, 1, Z)," &
"59 (BC_1,  DCBAR,     output3, X, 61, 1, Z)," &
"60 (BC_1,  SUPBAR,    output3, X, 61, 1, Z)," &
"61 (BC_1,  *,        control, 1)," &
"62 (BC_1,  LOCKBAR,   output3, X, 61, 1, Z)," &
"63 (BC_1,  BREQ,      output3, X, 6, 1, Z)," &
"64 (BC_1,  A(31),     output3, X, 80, 1, Z)," &
"65 (BC_1,  A(30),     output3, X, 80, 1, Z)," &
"66 (BC_1,  A(29),     output3, X, 80, 1, Z)," &
"67 (BC_1,  A(28),     output3, X, 80, 1, Z)," &
"68 (BC_1,  A(27),     output3, X, 80, 1, Z)," &
"69 (BC_1,  A(26),     output3, X, 80, 1, Z)," &
"70 (BC_1,  A(25),     output3, X, 80, 1, Z)," &
"71 (BC_1,  A(24),     output3, X, 80, 1, Z)," &
"72 (BC_1,  A(23),     output3, X, 80, 1, Z)," &
"73 (BC_1,  A(22),     output3, X, 80, 1, Z)," &
"74 (BC_1,  A(21),     output3, X, 80, 1, Z)," &
"75 (BC_1,  A(20),     output3, X, 80, 1, Z)," &
    
```

**Example 2. Boundary-Scan Description Language (BSDL) for PQ2 Package Example (Sheet 8 of 8)**

```

"76 (BC_1, A(19), output3, X, 80, 1, Z)," &
"77 (BC_1, A(18), output3, X, 80, 1, Z)," &
"78 (BC_1, A(17), output3, X, 80, 1, Z)," &
"79 (BC_1, A(16), output3, X, 80, 1, Z)," &
"80 (BC_1, *, control, 1)," &
"81 (BC_1, A(15), output3, X, 80, 1, Z)," &
"82 (BC_1, A(14), output3, X, 80, 1, Z)," &
"83 (BC_1, A(13), output3, X, 80, 1, Z)," &
"84 (BC_1, A(12), output3, X, 80, 1, Z)," &
"85 (BC_1, A(11), output3, X, 80, 1, Z)," &
"86 (BC_1, A(10), output3, X, 80, 1, Z)," &
"87 (BC_1, A(9), output3, X, 80, 1, Z)," &
"88 (BC_1, A(8), output3, X, 80, 1, Z)," &
"89 (BC_1, A(7), output3, X, 80, 1, Z)," &
"90 (BC_1, A(6), output3, X, 80, 1, Z)," &
"91 (BC_1, A(5), output3, X, 80, 1, Z)," &
"92 (BC_1, A(4), output3, X, 80, 1, Z)," &
"93 (BC_1, A(3), output3, X, 80, 1, Z)," &
"94 (BC_1, A(2), output3, X, 80, 1, Z)," &
"95 (BC_4, NMIBAR, input, X)," &
"96 (BC_4, XINTBAR(7), input, X)," &
"97 (BC_4, XINTBAR(6), input, X)," &
"98 (BC_4, XINTBAR(5), input, X)," &
"99 (BC_4, XINTBAR(4), input, X)," &
"100 (BC_4, XINTBAR(3), input, X)," &
"101 (BC_4, XINTBAR(2), input, X)," &
"102 (BC_4, XINTBAR(1), input, X)," &
"103 (BC_4, XINTBAR(0), input, X)," &
"104 (BC_4, RESETBAR, input, X)," &
"105 (BC_4, CLKIN, input, X)," &
"106 (BC_1, CT(3), output3, X, 80, 1, Z)," &
"107 (BC_1, CT(2), output3, X, 80, 1, Z)," &
"108 (BC_1, CT(1), output3, X, 80, 1, Z)," &
"109 (BC_1, CT(0), output3, X, 80, 1, Z)," &
"110 (BC_1, PCHKBAR, output3, X, 111, 1, Z)," &
"111 (BC_1, *, control, 1)";

end Ha_Processor;

```



**Table 26. Data Sheet Version -006 to -007 Revision History**

Section	Description
Entire data sheet	Formatted in new template.
"32-Bit Parallel Architecture" on page 1	Revised "1.2 Gbyte Internal Bandwidth (75 MHz) to "1.28 Gbyte ... (80 MHz)".
Copyright Page	Updated legal text.
Section 3.0, "Package Information" on page 6	Added paragraph two and Table 5.
Table 7 "80960Hx Processor Family Pin Descriptions" on page 8	Corrected minor typeset and spacing errors. BREQ; Revised description. ONCE; last sentence, changed "low" to "high". TDI and TMS; removed last sentence, "Pull this pin low when not in use."
Figure 2 "80960Hx 168-Pin PGA Pinout — View from Top (Pins Facing Down)" on page 12	Added insert package marking diagram.
Figure 4 "80960Hx 208-Pin PQ4 Pinout" on page 18	Added insert package marking diagram.
Table 10 "80960Hx PQ4 Pinout — Signal Name Order" on page 19	Corrected TDO ("O" was zero) and revised alphabetical ordering.
Table 11 "80960Hx PQ4 Pinout — Pin Number Order" on page 21	Corrected TDO ("O" was zero) and revised alphabetical ordering.
Section 4.1, "Absolute Maximum Ratings" on page 29	Revised "V <sub>CC</sub> " to "VCC5" for "Voltage on Other Pins ...".
Section 4.5, "VCCPLL Pin Requirements" on page 31	Added section.
Table 21 "80960Hx DC Characteristics" on page 32	Added footnote (1) to "I <sub>LO</sub> " notes column for "TDO" pin. Added footnote (10) to "C <sub>IN</sub> , C <sub>OUT</sub> and C <sub>I/O</sub> " pin.
Table 22 "80960Hx AC Characteristics" on page 34	Added overbars where required. Modified "T <sub>DVNH</sub> " to list separate specifications for 3.3 V and 5 V. Modified "T <sub>OV2</sub> , T <sub>OH2</sub> and T <sub>TVEL</sub> " to reflect specific 80960HA, 80960HD and 80960HT values.
Figure 23 "I <sub>CC</sub> Active (Power Supply) vs. Frequency" on page 43	Changed "5" to "0" on "CLKIN Frequency" axis.
Figure 49 "BREQ and BSTALL Operation" on page 66	Added figure and following text.