

FEATURES

- 6 channels of LNA, PGA, AAF
- 1 channel of direct-to-ADC
- Programmable gain amplifier (PGA)
- Includes low noise preamplifier (LNA)
- SPI-programmable gain = 16 dB to 34 dB in 6 dB steps
- Antialiasing filter (AAF)
- Programmable third-order low-pass elliptic filter (LPF) from 1 MHz to 12 MHz
- Analog-to-digital converter (ADC)
- 12 bits of accuracy up to 72 MSPS
- SNR = 67 dB
- SFDR = 68 dB
- Low power, 170 mW per channel at 12 bits/72 MSPS
- Low noise, 3.5 nV/ $\sqrt{\text{Hz}}$ maximum of input referred voltage noise
- Power-down mode
- 72-lead, 10 mm \times 10 mm, LFCSP package
- Specified from -40°C to $+105^{\circ}\text{C}$
- Qualified for automotive applications

APPLICATIONS

- Automotive radar
 - Adaptive cruise control
 - Collision avoidance
 - Blind spot detection
 - Self-parking
 - Electronic bumper

GENERAL DESCRIPTION

The **AD8283** is designed for low cost, low power, compact size, flexibility, and ease of use. It contains six channels of a low noise preamplifier (LNA) with a programmable gain amplifier (PGA) and an antialiasing filter (AAF) plus one direct-to-ADC channel, all integrated with a single 12-bit analog-to-digital converter (ADC).

Each channel features a gain range of 16 dB to 34 dB in 6 dB increments and an ADC with a conversion rate of up to 72 MSPS. The combined input-referred noise voltage of the entire channel is 3.5 nV/ $\sqrt{\text{Hz}}$ at maximum gain. The channel is optimized for dynamic performance and low power in applications where a small package size is critical.

FUNCTIONAL BLOCK DIAGRAM

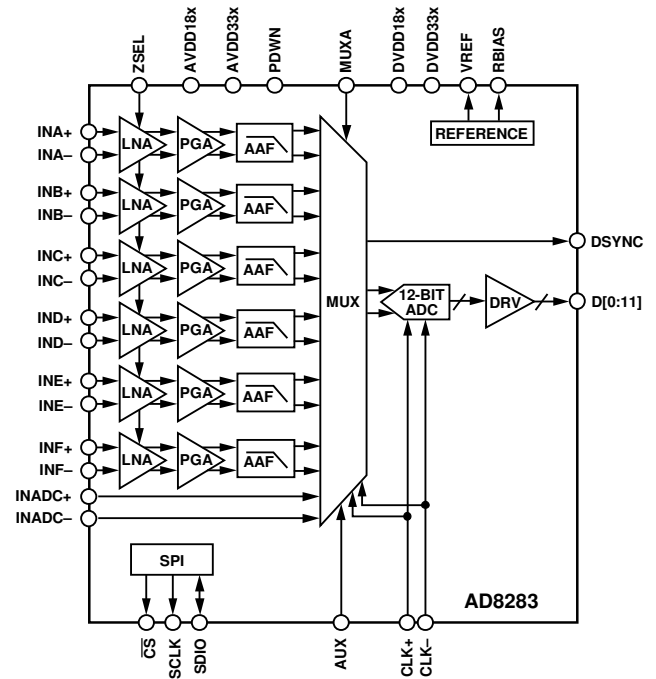

Figure 1.

Fabricated in an advanced CMOS process, the **AD8283** is available in a 10 mm \times 10 mm, RoHS-compliant, 72-lead LFCSP. It is specified over the automotive temperature range of -40°C to $+105^{\circ}\text{C}$.

Table 1. Related Devices

Part No.	Description
AD8285	4-Channel LNA/PGA/AAF, pseudosimultaneous channel sampling with ADC
AD8284	4-Channel LNA/PGA/AAF, sequential channel sampling with ADC
ADA8282	4-Channel LNA/PGA

TABLE OF CONTENTS

Features	1	Clock Jitter Considerations.....	17
Applications.....	1	SDIO Pin	17
Functional Block Diagram.....	1	SCLK Pin.....	17
General Description	1	$\overline{\text{CS}}$ Pin.....	17
Revision History.....	2	RBIAS Pin.....	17
Specifications.....	3	Voltage Reference	17
AC Specifications.....	3	Power and Ground Recommendations.....	18
Digital Specifications	5	Exposed Paddle Thermal Heat Slug Recommendations.....	18
Switching Specifications.....	6	Serial Peripheral Interface (SPI)	19
Absolute Maximum Ratings	7	Hardware Interface.....	19
ESD Caution.....	7	Memory Map.....	21
Pin Configuration and Function Descriptions.....	8	Reading the Memory Map Table.....	21
Typical Performance Characteristics	10	Logic Levels.....	21
Theory of Operation.....	14	Reserved Locations.....	21
Radar Receive Path AFE.....	14	Default Values.....	21
Channel Overview	15	Application Diagrams.....	25
ADC.....	16	Outline Dimensions	27
Clock Input Considerations.....	16	Ordering Guide	27
Clock Duty Cycle Considerations.....	17	Automotive Products.....	27

REVISION HISTORY

8/15—Rev. B to Rev. C

Changed AD951x/AD952x to AD9515/AD9520-0... Throughout
 Added Table 1; Renumbered Sequentially 1

10/14—Rev. A to Rev. B

Changes to Addr. (Hex) 0x15, Table 8.....23
 Changes to Ordering Guide.....27

11/13—Rev. 0 to Rev. A

Changed Maximum f_{SAMPLE} from 80 MSPS to 72 MSPS
 Throughout
 Changed Clock Pulse Width High/Low ($t_{\text{EH}}/t_{\text{EL}}$) at 72 MSPS
 from 6.25 ns to 6.94ns; Table 3.....6
 Changes to Figure 25

14
 Changes to Register Address 10 Bits[5:0] and Register
 Address 0x12, Bit 3; Table 8.....23
 Updated Outline Dimensions.....27

4/11—Revision 0: Initial Version

SPECIFICATIONS

AC SPECIFICATIONS

AVDD18x = 1.8 V, AVDD33x = 3.3 V, DVDD18x = 1.8 V, DVDD33x = 3.3 V, 1.024 V internal ADC reference, $f_{IN} = 2.5$ MHz, $f_{SAMPLE} = 72$ MSPS, $R_S = 50 \Omega$, LNA + PGA gain = 34 dB, LPF cutoff = $f_{SAMPLE}/4$, full channel mode, 12-bit operation, temperature = -40°C to $+105^\circ\text{C}$, unless otherwise noted.

Table 2.

Parameter ¹	Conditions	AD8283W			Unit
		Min	Typ	Max	
ANALOG CHANNEL CHARACTERISTICS					
Gain	LNA, PGA, and AAF channel		16/22/28/34		dB
Gain Range			18		dB
Gain Error		-1.25		+1.25	dB
Input Voltage Range	Channel gain = 16 dB		0.25		V p-p
	Channel gain = 22 dB		0.125		
	Channel gain = 28 dB		0.0625		
	Channel gain = 34 dB		0.03125		
Input Resistance	200 Ω input impedance selected	0.180	0.230	0.280	k Ω
	200 k Ω input impedance selected	160	200	240	
Input Capacitance			22		pF
Input-Referred Voltage Noise	Max gain at 1 MHz		1.85		nV/ $\sqrt{\text{Hz}}$
	Min gain at 1 MHz		6.03		nV/ $\sqrt{\text{Hz}}$
Noise Figure	Max gain, $R_S = 50 \Omega$, unterminated		7.1		dB
	Max Gain, $R_S=R_{IN} = 50 \Omega$		12.7		dB
Output Offset	Gain = 16 dB	-60		+60	LSB
	Gain = 34 dB	-250		+250	LSB
AAF Low-Pass Filter Cutoff	-3 dB, programmable		1.0 to 12.0		MHz
AAF Low-Pass Filter Cutoff Tolerance	After filter autotune	-10	± 5	+10	%
AAF Attenuation in Stop Band	Third order elliptical filter				
	2 \times cutoff		30		dB
	3 \times cutoff		40		dB
Group Delay Variation	Filter set at 2 MHz		400		ns
Channel-to-Channel Phase Variation	Frequencies up to -3 dB	-5	± 0.5	+5	Degrees
	1/4 of -3 dB frequency	-1		+1	Degrees
Channel-to-Channel Gain Matching	Frequencies up to -3 dB	-0.5	± 0.1	+0.5	dB
	1/4 of -3 dB frequency	-0.25		+0.25	dB
1 dB Compression	Relative to output		9.8		dBm
Crosstalk			-70	-55	dBc
POWER SUPPLY					
AVDD18x		1.7	1.8	1.9	V
AVDD33x		3.1	3.3	3.5	V
DVDD18x		1.7	1.8	1.9	V
DVDD33x		3.1	3.3	3.5	V
I_{AVDD18}	Full-channel mode			190	mA
I_{AVDD33}	Full-channel mode			190	mA
I_{DVDD18}				22	mA
I_{DVDD33}				2	mA
Total Power Dissipation – per channel	Full-channel mode, no signal, typical supply voltage \times maximum supply current; excludes output current			170	mW
Power-Down Dissipation			5		mW
Power Supply Rejection Ratio (PSRR)	Relative to input		1.6		mV/V

Parameter ¹	Conditions	AD8283W			Unit
		Min	Typ	Max	
ADC					
Resolution			12		Bits
Max Sample Rate			72		MSPS
Signal-to-Noise Ratio (SNR)	$f_{IN} = 1 \text{ MHz}$		68.5		dB
Signal-to-Noise and Distortion (SINAD)			66		dB
SNRFS			68		dB
Differential Nonlinearity (DNL)	Guaranteed no missing codes			1	LSB
Integral Nonlinearity (INL)				10	LSB
Effective Number of Bits (ENOB)			10.67		LSB
ADC Output Characteristics					
Maximum Cap Load	Per bit		20		pF
$I_{D\text{VDD}33}$ Peak Current with Cap Load	Peak current per bit when driving a 20 pF load; can be programmed via the SPI port if required			40	mA
ADC REFERENCE					
Output Voltage Error	$V_{REF} = 1.024 \text{ V}$			± 25	mV
Load Regulation	At 1.0 mA, $V_{REF} = 1.024 \text{ V}$		2		mV
Input Resistance			6		k Ω
FULL CHANNEL CHARACTERISTICS	LNA, PGA, AAF, and ADC				
SNRFS	$F_{IN} = 1 \text{ MHz}$				
	Gain = 16 dB		68		dB
	Gain = 22 dB		68		dB
	Gain = 28 dB		68		dB
	Gain = 34 dB		66		dB
SINAD	$F_{IN} = 1 \text{ MHz}$				
	Gain = 16 dB		67		dB
	Gain = 22 dB		68		dB
	Gain = 28 dB		67		dB
	Gain = 34 dB		66		dB
SFDR	$F_{IN} = 1 \text{ MHz}$				
	Gain = 16 dB		68		dB
	Gain = 22 dB		74		dB
	Gain = 28 dB		74		dB
	Gain = 34 dB		73		dB
Harmonic Distortion					
Second Harmonic	$F_{IN} = 1 \text{ MHz}$ at -10 dBFS , gain = 16 dB		-70		dBc
	$F_{IN} = 1 \text{ MHz}$ at -10 dBFS , gain = 34 dB		-70		dBc
Third Harmonic	$F_{IN} = 1 \text{ MHz}$ at -10 dBFS , gain = 16 dB		-66		dBc
	$F_{IN} = 1 \text{ MHz}$ at -10 dBFS , gain = 34 dB		-75		dBc
IM3 Distortion	$F_{IN1} = 1 \text{ MHz}$, $F_{IN2} = 1.1 \text{ MHz}$, -1 dBFS , gain = 34 dB		-69		dBc
Gain Response Time			600		ns
Overdrive Recovery Time			200		ns

¹ See the [AN-835 Application Note](#), *Understanding High Speed ADC Testing and Evaluation*, for a complete set of definitions and how these tests were completed.

DIGITAL SPECIFICATIONS

AVDD18x = 1.8 V, AVDD33 = 3.3 V, DVDD18 = 1.8 V, DVDD33 = 3.3 V, 1.024 V internal ADC reference, $f_{IN} = 2.5$ MHz, $f_{SAMPLE} = 72$ MSPS, $R_S = 50 \Omega$, LNA + PGA gain = 34 dB, LPF cutoff = $f_{SAMPLE}/4$, full channel mode, 12-bit operation, temperature = -40°C to $+105^\circ\text{C}$, unless otherwise noted.

Table 3.

Parameter ¹	Temperature	Min	Typ	Max	Unit
CLOCK INPUTS (CLK+, CLK-)					
Logic Compliance			CMOS/LVDS/LVPECL		
Differential Input Voltage ²	Full	250			mV p-p
Input Common-Mode Voltage	Full		1.2		V
Input Resistance (Differential)	25°C		20		kΩ
Input Capacitance	25°C		1.5		pF
LOGIC INPUTS (PDWN, SCLK, AUX, MUXA, ZSEL)					
Logic 1 Voltage	Full	1.2		3.6	V
Logic 0 Voltage	Full			0.3	V
Input Resistance	25°C		30		kΩ
Input Capacitance	25°C		0.5		pF
LOGIC INPUT (CS)					
Logic 1 Voltage	Full	1.2		3.6	V
Logic 0 Voltage	Full			0.3	V
Input Resistance	25°C		70		kΩ
Input Capacitance	25°C		0.5		pF
LOGIC INPUT (SDIO)					
Logic 1 Voltage	Full	1.2		DVDD33x + 0.3	V
Logic 0 Voltage	Full	0		0.3	V
Input Resistance	25°C		30		kΩ
Input Capacitance	25°C		2		pF
LOGIC OUTPUT (SDIO) ³					
Logic 1 Voltage ($I_{OH} = 800 \mu\text{A}$)	Full	3.0			V
Logic 0 Voltage ($I_{OL} = 50 \mu\text{A}$)	Full			0.3	V
LOGIC OUTPUT (D[11:0], DSYNC)					
Logic 1 Voltage ($I_{OH} = 2 \text{ mA}$)	Full	3.0			V
Logic 0 Voltage ($I_{OL} = 2 \text{ mA}$)	Full			0.05	V

¹ See the [AN-835 Application Note](#), *Understanding High Speed ADC Testing and Evaluation*, for a complete set of definitions and how these tests were completed.

² Specified for LVDS and LVPECL only.

³ Specified for 13 SDIO pins sharing the same connection.

SWITCHING SPECIFICATIONS

AVDD18x = 1.8 V, AVDD33x = 3.3 V, DVDD18x = 1.8 V, DVDD33x = 3.3 V, 1.024 V internal ADC reference, $f_{IN} = 2.5$ MHz, $f_{SAMPLE} = 72$ MSPS, $R_S = 50 \Omega$, LNA + PGA gain = 34 dB, LPF cutoff = $f_{SAMPLE}/4$, full channel mode, 12-bit operation, temperature = -40°C to $+105^\circ\text{C}$, unless otherwise noted.

Table 4.

Parameter ¹	Temperature	Min	Typ	Max	Unit
CLOCK					
Clock Rate	Full	10		72	MSPS
Clock Pulse Width High (t_{EH}) at 72 MSPS	Full		6.94		ns
Clock Pulse Width Low (t_{EL}) at 72 MSPS	Full		6.94		ns
Clock Pulse Width High (t_{EH}) at 40 MSPS	Full		12.5		ns
Clock Pulse Width Low (t_{EL}) at 40 MSPS	Full		12.5		ns
OUTPUT PARAMETERS					
Propagation Delay (t_{PD}) at 72 MSPS	Full	1.5	2.5	5.0	ns
Rise Time (t_r)	Full		1.9		ns
Fall Time (t_f)	Full		1.2		ns
Data Set-Up Time (t_{DS}) at 72 MSPS	Full	9.0	10.0	11.0	ns
Data Hold Time (t_{DH}) at 72 MSPS	Full	1.5	4.0	5.0	ns
Data Set-Up Time (t_{DS}) at 40 MSPS	Full	21.5	22.5	23.5	ns
Data Hold Time (t_{DH}) at 40 MSPS	Full	1.5	4.0	5.0	ns
Pipeline Latency	Full		7		Clock cycles

¹ See the [AN-835 Application Note](#), *Understanding High Speed ADC Testing and Evaluation*, for a complete set of definitions and how these tests were completed.

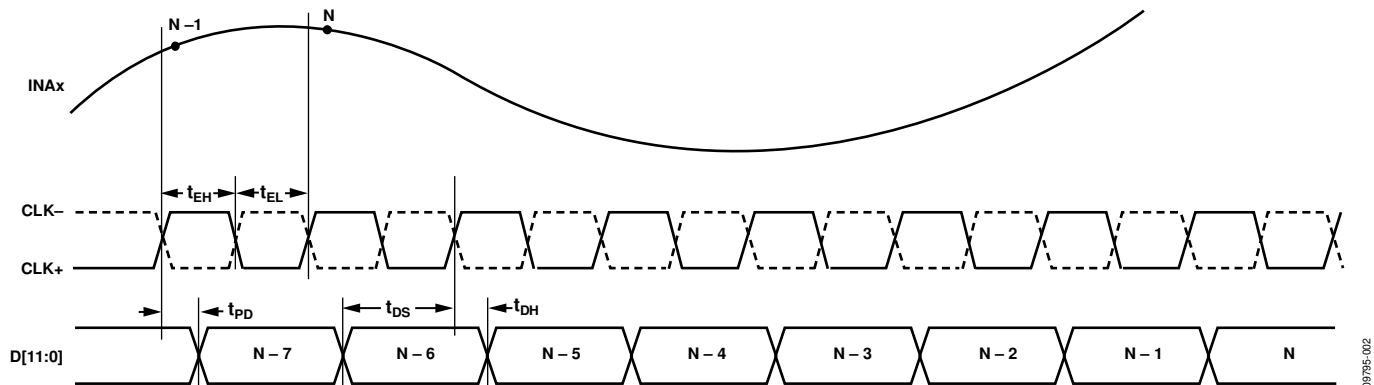

Figure 2. Timing Definitions for Switching Specifications

097945-002

ABSOLUTE MAXIMUM RATINGS

Table 5.

Parameter	With Respect To	Rating
Electrical		
AVDD18x	GND	-0.3 V to +2.0 V
AVDD33x	GND	-0.3 V to +3.5 V
DVDD18x	GND	-0.3 V to +2.0 V
DVDD33x	GND	-0.3 V to +3.5 V
Analogue Inputs INx+, INx-	GND	-0.3 V to +3.5 V
Auxiliary Inputs INADC+, INADC-	GND	-0.3 V to +2.0 V
Digital Outputs D[11:0], DSYNC, SDIO	GND	-0.3 V to +3.5 V
CLK+, CLK-	GND	-0.3 V to +3.9 V
PDWN, SCLK, $\overline{\text{CS}}$, AUX, MUXA, ZSEL	GND	-0.3 V to +3.9 V
RBIAS, VREF	GND	-0.3 V to +2.0 V
Environmental		
Operating Temperature Range (Ambient)		-40°C to +105°C
Storage Temperature Range (Ambient)		-65°C to +150°C
Maximum Junction Temperature		150°C
Lead Temperature (Soldering, 10 sec)		300°C

Stresses at or above those listed under Absolute Maximum Ratings may cause permanent damage to the product. This is a stress rating only; functional operation of the product at these or any other conditions above those indicated in the operational section of this specification is not implied. Operation beyond the maximum operating conditions for extended periods may affect product reliability.

ESD CAUTION



ESD (electrostatic discharge) sensitive device. Charged devices and circuit boards can discharge without detection. Although this product features patented or proprietary protection circuitry, damage may occur on devices subjected to high energy ESD. Therefore, proper ESD precautions should be taken to avoid performance degradation or loss of functionality.

PIN CONFIGURATION AND FUNCTION DESCRIPTIONS

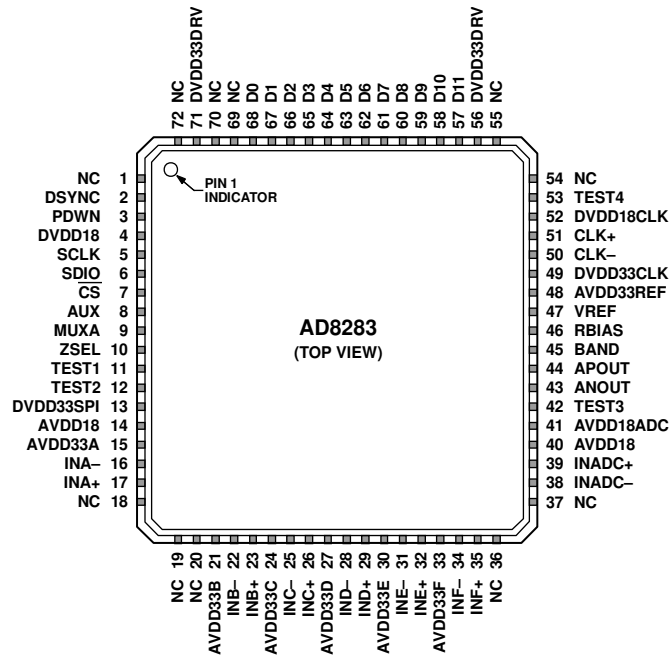

- NOTES**
1. NC = NO CONNECT. DO NOT CONNECT TO THIS PIN.
 2. THE EXPOSED PADDLE SHOULD BE TIED TO ANALOG/DIGITAL GROUND PLANE.

09795-003

Figure 3.

Table 6. Pin Function Descriptions

Pin No.	Name	Description
0	GND	Ground. Exposed paddle on the bottom side; should be tied to the analog/digital ground plane.
1	NC	No Connection. Pin can be tied to any potential.
2	DSYNC	Data Out Synchronization.
3	PDWN	Full Power-Down. Logic high overrides SPI and powers down the part, logic low allows selection through SPI.
4	DVDD18	1.8 V Digital Supply.
5	SCLK	Serial Clock.
6	SDIO	Serial Data Input/Output.
7	CS	Chip Select Bar.
8	AUX	Logic high forces to Channel ADC (INADC+/INADC-); AUX has a higher priority than MUXA.
9	MUXA	Logic high forces to Channel A unless AUX is asserted.
10	ZSEL	Input Impedance Select. Logic high overrides SPI and sets it to 200 kΩ; logic low allows selection through SPI.
11	TEST1	Pin should not be used; tie to ground.
12	TEST2	Pin should not be used; tie to ground.
13	DVDD33SPI	3.3 V Digital Supply, SPI Port.
14	AVDD18	1.8 V Analog Supply.
15	AVDD33A	3.3 V Analog Supply, Channel A.
16	INA-	Negative LNA Analog Input for Channel A.
17	INA+	Positive LNA Analog Input for Channel A.
18	NC	No Connect. Pin can be tied to any potential.
19	NC	No Connect. Pin can be tied to any potential.
20	NC	No Connect. Pin can be tied to any potential.
21	AVDD33B	3.3 V Analog Supply, Channel B.
22	INB-	Negative LNA Analog Input for Channel B.
23	INB+	Positive LNA Analog Input for Channel B.
24	AVDD33C	3.3 V Analog Supply, Channel C.
25	INC-	Negative LNA Analog Input for Channel C.
26	INC+	Positive LNA Analog Input for Channel C.

Pin No.	Name	Description
27	AVDD33D	3.3 V Analog Supply, Channel D.
28	IND-	Negative LNA Analog Input for Channel D.
29	IND+	Positive LNA Analog Input for Channel D.
30	AVDD33E	3.3 V Analog Supply, Channel E.
31	INE-	Negative LNA Analog Input for Channel E.
32	INE+	Positive LNA Analog Input for Channel E.
33	AVDD33F	3.3 V Analog Supply, Channel F.
34	INF-	Negative LNA Analog Input for Channel F.
35	INF+	Positive LNA Analog Input for Channel F.
36	NC	No Connect, Pin can be tied to any potential.
37	NC	No Connect. Pin can be tied to any potential.
38	INADC-	Negative Analog Input for Alternate Channel F (ADC Only).
39	INADC+	Positive Analog Input for Alternate Channel F (ADC Only).
40	AVDD18	1.8 V Analog Supply.
41	AVDD18ADC	1.8 V Analog Supply, ADC.
42	TEST3	Pin should not be used; tie to ground.
43	ANOUT	Analog Outputs (Debug Purposes Only). Pin should be floated.
44	APOUT	Analog Outputs (Debug Purposes Only). Pin should be floated.
45	BAND	Band Gap Voltage (Debug Purposes Only). Pin should be floated.
46	RBIAS	External resistor to set the internal ADC core bias current.
47	VREF	Voltage Reference Input/Output.
48	AVDD33REF	3.3 V Analog Supply, References.
49	DVDD33CLK	3.3 V Digital Supply, Clock.
50	CLK-	Clock Input Complement.
51	CLK+	Clock Input True.
52	DVDD18CLK	1.8 V Digital Supply, Clock.
53	TEST4	Pin should not be used; tie to ground.
54	NC	No Connect. Pin can be tied to any potential.
55	NC	No Connect. Pin can be tied to any potential.
56	DVDD33DRV	3.3 V Digital Supply, Output Driver.
57	D11	ADC Data Out (MSB).
58	D10	ADC Data Out.
59	D9	ADC Data Out.
60	D8	ADC Data Out.
61	D7	ADC Data Out.
62	D6	ADC Data Out.
63	D5	ADC Data Out.
64	D4	ADC Data Out.
65	D3	ADC Data Out.
66	D2	ADC Data Out.
67	D1	ADC Data Out.
68	D0	ADC Data Out (LSB).
69	NC	No Connect. Pin should be left open.
70	NC	No Connect. Pin should be left open.
71	DVDD33DRV	3.3 V Supply, Output Driver.
72	NC	No Connect. Pin can be tied to any potential.

TYPICAL PERFORMANCE CHARACTERISTICS

$V_S = 3.3\text{ V}$, 1.8 V , $T_A = 25^\circ\text{C}$, $F_S = 72\text{ MSPS}$, $R_{IN} = 200\text{ k}\Omega$, $V_{REF} = 1.0\text{ V}$.

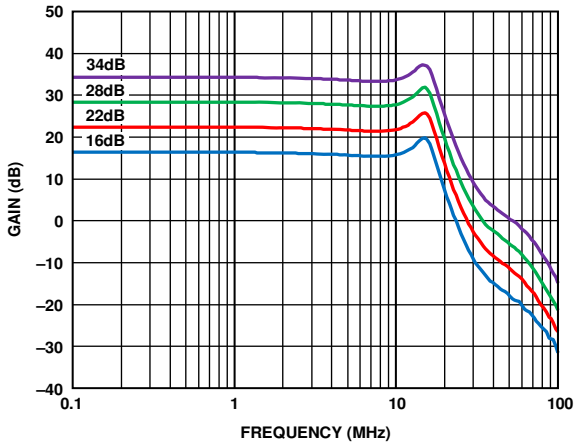

Figure 4. Channel Gain vs. Frequency

09795-014

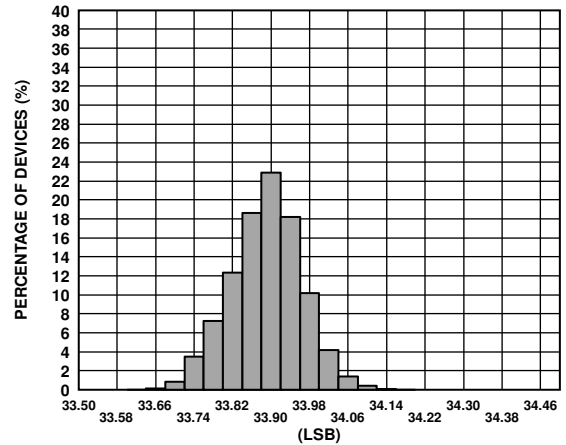

Figure 7. Gain Error Histogram (Gain = 34 dB)

09795-003

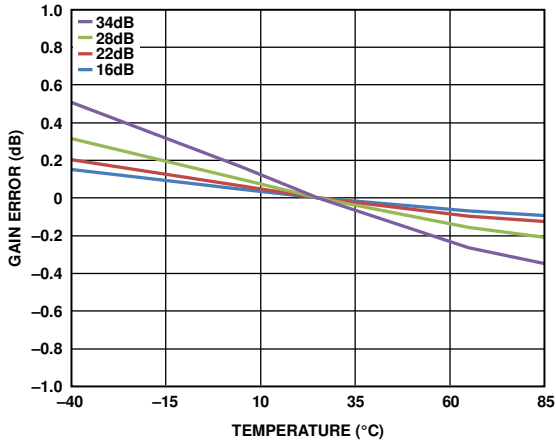

Figure 5. Gain Error vs. Temperature at All Gains

09795-038

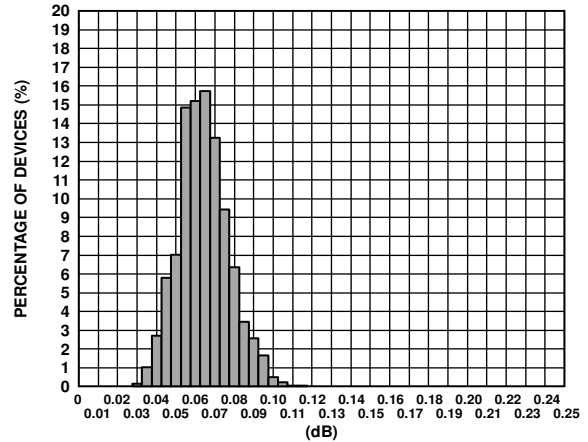

Figure 8. Channel-to-Channel Gain Matching (Gain = 16 dB)

09795-034

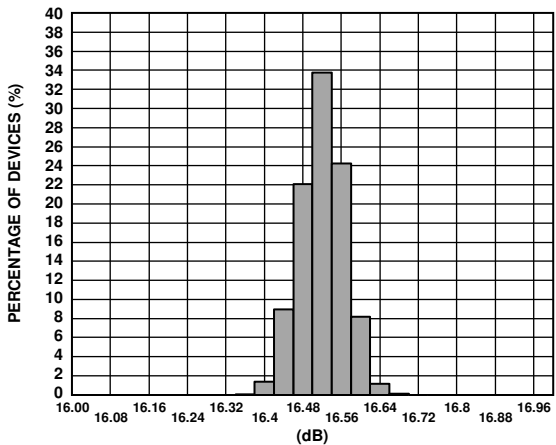

Figure 6. Gain Error Histogram (Gain = 16 dB)

09795-032

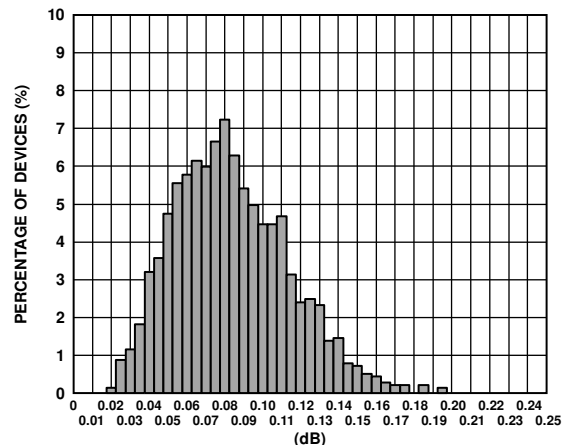

Figure 9. Channel-to-Channel Gain Matching (Gain = 34 dB)

09795-035

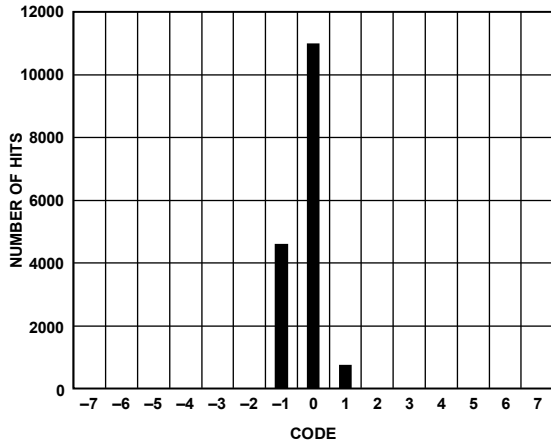

Figure 10. Output Referred Noise Histogram (Gain = 16 dB)

09795-015

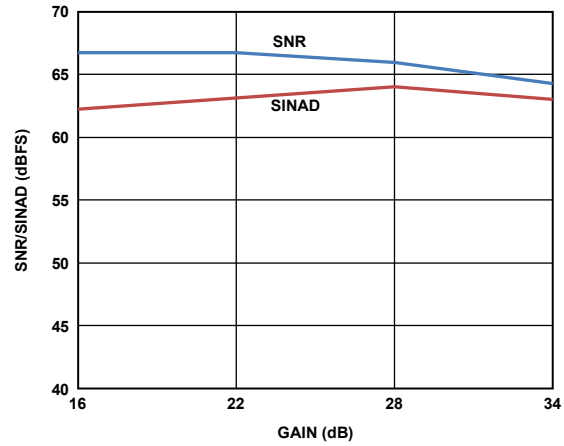

Figure 13. SNR vs. Gain

09795-017

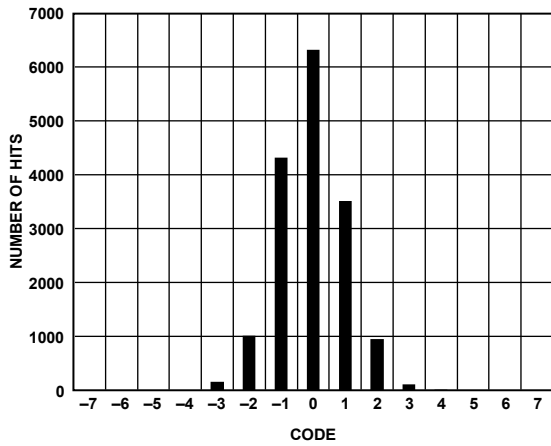

Figure 11. Output Referred Noise Histogram (Gain = 34 dB)

09795-016

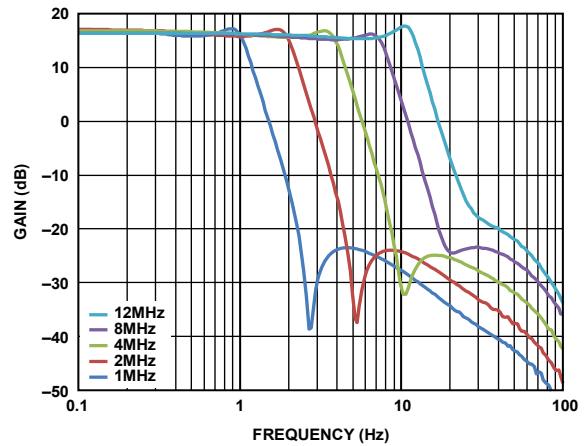

Figure 14. Filter Response

09795-022

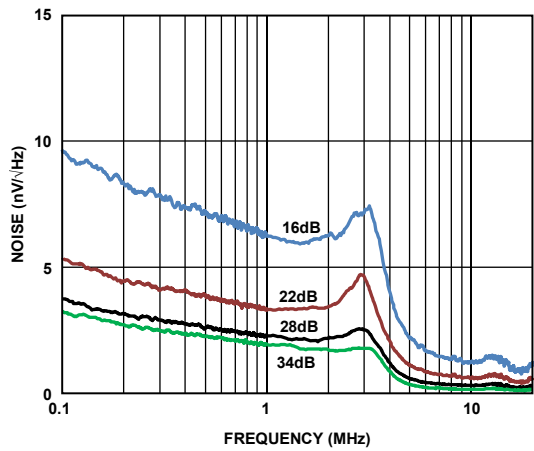

Figure 12. Short Circuit Input-Referred Noise vs. Frequency

09795-030

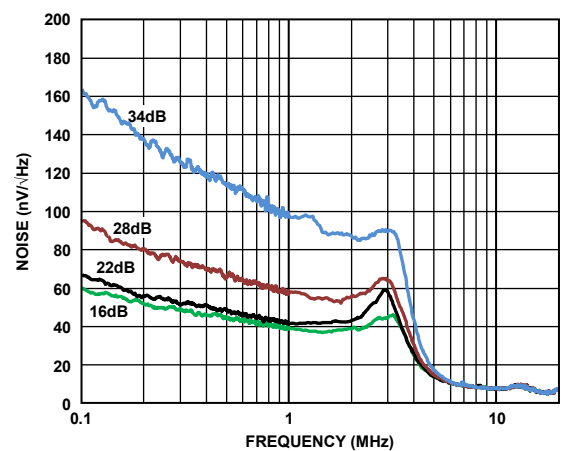

Figure 15. Short-Circuit Output-Referred Noise vs. Frequency

09795-031

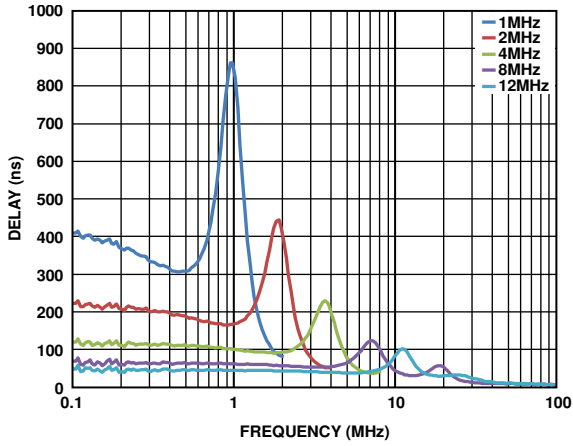

Figure 16. Group Delay vs. Frequency

09795-019

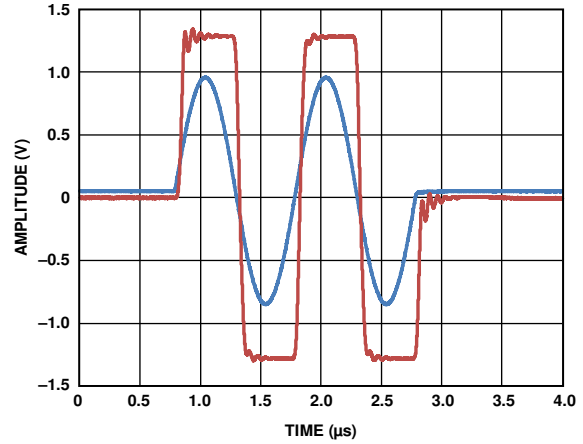

Figure 19. Overdrive Recovery

09795-041

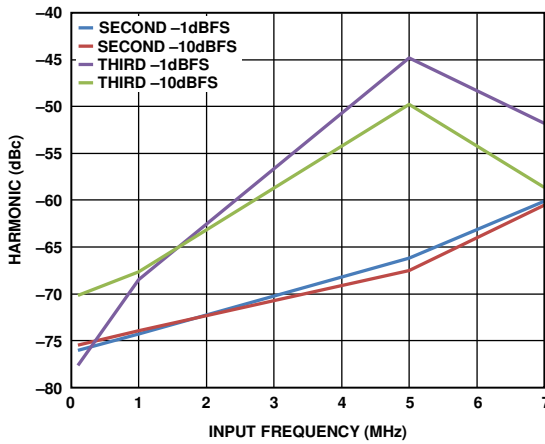

Figure 17. Harmonic Distortion vs. Frequency

09795-039

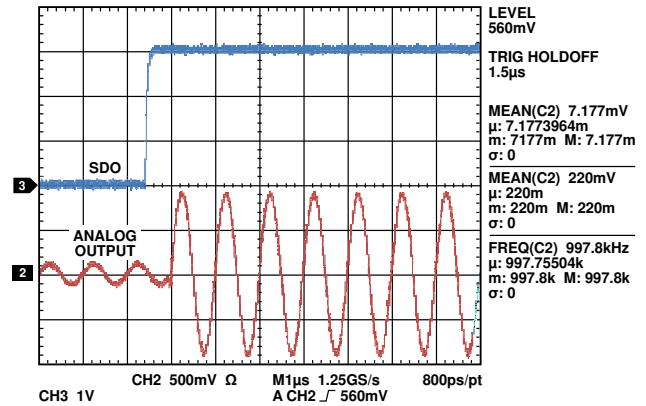

Figure 20. Gain Step Response

09795-024

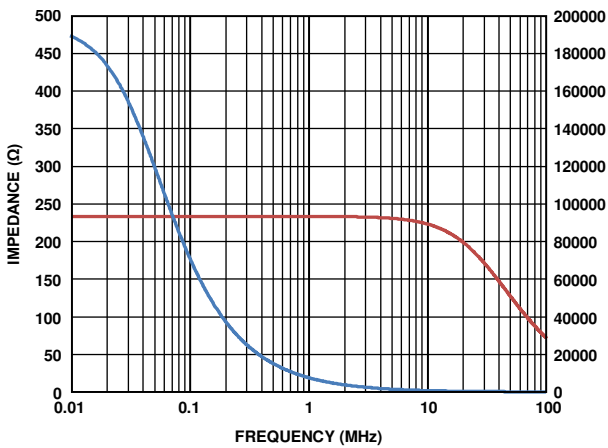

Figure 18. R_{IN} vs. Frequency

09795-040

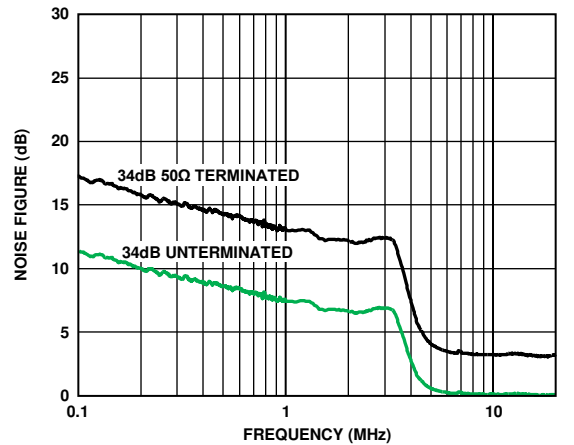

Figure 21. Noise Figure vs. Frequency

09795-042

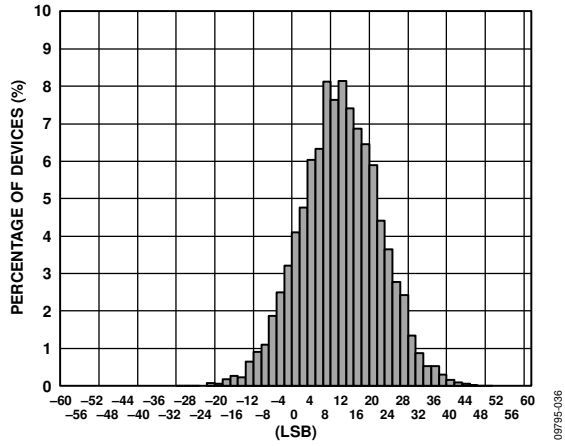

Figure 22. Channel Offset Distribution (Gain = 16 dB)

09795-036

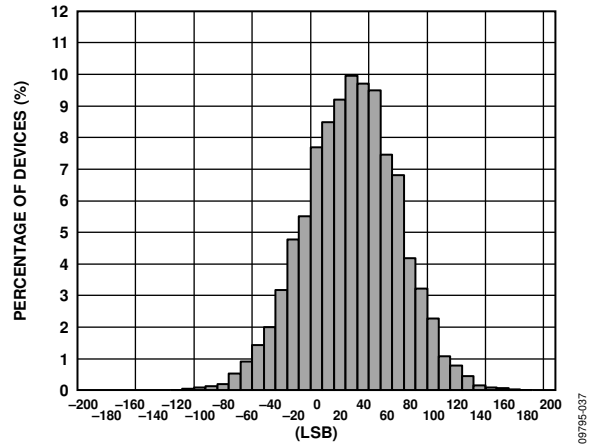

Figure 23. Channel Offset Distribution (Gain = 34 dB)

09795-037

THEORY OF OPERATION

RADAR RECEIVE PATH AFE

The primary application for the AD8283 is high-speed ramp, frequency modulated, continuous wave radar (HSR-FMCW radar). Figure 25 shows a simplified block diagram of an HSR-FMCW radar system. The signal chain requires multiple channels, each including a low noise amplifier (LNA), a programmable gain amplifier (PGA), an antialiasing filter (AAF), and an analog-to-digital converter (ADC). The AD8283 provides all of these key components in a single 10 × 10 LFCSP package.

The performance of each component is designed to meet the demands of an HSR-FMCW radar system. Some examples of these performance metrics are the LNA noise, PGA gain range,

AAF cutoff characteristics, and ADC sample rate and resolution.

The AD8283 includes a multiplexer (mux) in front of the ADC as a cost saving alternative to having an ADC for each channel. The mux automatically switches between each active channel after each ADC sample. The DSYNC output indicates when Channel A data is at the ADC output, and data for each active channel follows sequentially with each clock cycle.

The effective sample rate for each channel is reduced by a factor equal to the number of active channels. The ADC resolution of 12 bits with up to 72 MSPS sampling satisfies the requirements for most HSR-FMCW approaches.

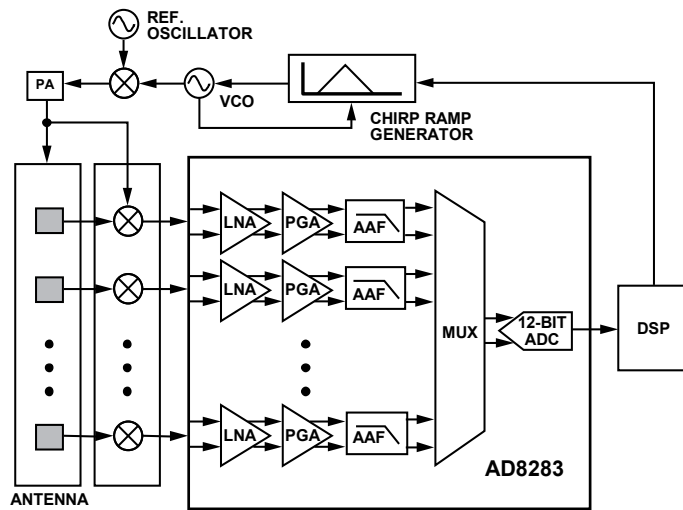

Figure 24. Radar System Overview

09795-004

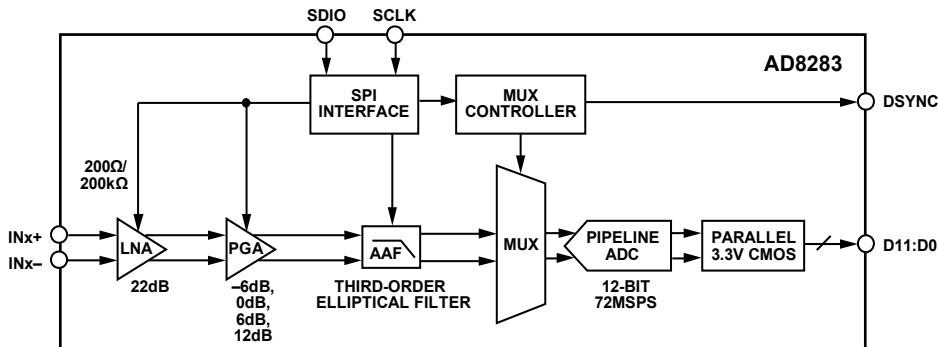

Figure 25. Simplified Block Diagram of a Single Channel

09795-005

CHANNEL OVERVIEW

Each channel contains an LNA, a PGA, and an AAF in the signal path. The LNA input impedance can be either 200 Ω or 200 k Ω . The PGA has selectable gains that result in channel gains ranging from 16 dB to 34 dB. The AAF has a three-pole elliptical response with a selectable cutoff frequency. The mux is synchronized with the ADC and automatically selects the next active channel after the ADC acquires a sample.

The signal path is fully differential throughout to maximize signal swing and reduce even-order distortion including the LNA, which is designed to be driven from a differential signal source.

Low Noise Amplifier (LNA)

Good noise performance relies on a proprietary ultralow noise LNA at the beginning of the signal chain, which minimizes the noise contributions on the following PGA and AAF. The input impedance can be either 200 Ω or 200 k Ω and is selected through the SPI port or by the ZSEL pin.

The LNA supports differential output voltages as high as 4.0 V p-p with positive and negative excursions of ± 1.0 V from a common-mode voltage of 1.5 V. With the output saturation level fixed, the channel gain sets the maximum input signal before saturation.

Low value feedback resistors and the current-driving capability of the output stage allow the LNA to achieve a low input-referred noise voltage of 3.5 nV/ $\sqrt{\text{Hz}}$ at a channel gain of 34 dB. The use of a fully differential topology and negative feedback minimizes second-order distortion. Differential signaling enables smaller swings at each output, further reducing third-order distortion.

Recommendation

To achieve the best possible noise performance, it is important to match the impedances seen by the positive and negative inputs. Matching the impedances ensures that any common-mode noise is rejected by the signal path.

Antialiasing Filter (AAF)

The filter that the signal reaches prior to the ADC is used to band limit the signal for antialiasing.

The antialiasing filter uses a combination of poles and zeros to create a third-order elliptical filter. An elliptical filter is used to achieve a sharp roll off after the cutoff frequency. The filter uses on-chip tuning to trim the capacitors to set the desired cutoff frequency. This tuning method reduces variations in the cutoff frequency due to standard IC process tolerances of resistors and capacitors. The default -3 dB low-pass filter cutoff is 1/3 or 1/4 the ADC sample clock rate. The cutoff can be scaled to 0.7, 0.8, 0.9, 1, 1.1, 1.2, or 1.3 times this frequency through the SPI.

Tuning is normally off to avoid changing the capacitor settings during critical times. The tuning circuit is enabled and disabled through the SPI. Initializing the tuning of the filter must be performed after initial power-up and after reprogramming the filter cutoff scaling or ADC sample rate. Occasional retuning during an idle time is recommended to compensate for temperature drift.

A cut-off range of 1 MHz to 12 MHz is possible. An example follows:

- Four channels selected: A, B, C, and AUX
- ADC clock: 30 MHz
- Per channel sample rate = $30/4 = 7.5$ MSPS
- Default tuned cutoff frequency = $7.5/4 = 1.88$ MHz

Mux and Mux Controller

The mux is designed to automatically scan through each active channel. The mux remains on each channel for one clock cycle, then switches to the next active channel. The mux switching is synchronized to the ADC sampling so that the mux switching and channel settling time do not interfere with ADC sampling.

As indicated in Table 9, Register Address 0C, Flex Mux Control, Channel A, is usually the first converted input. The one exception occurs when Channel AUX is the sole input (see Figure 26 for timing). Channel AUX is always forced to be the last converted input. Unselected codes put the respective channels (LNA, PGA, and Filter) in power-down mode unless Register Address 0C, Bit 6, is set to 1. Figure 26 shows the timing of the clock input and data/DSYNC outputs.

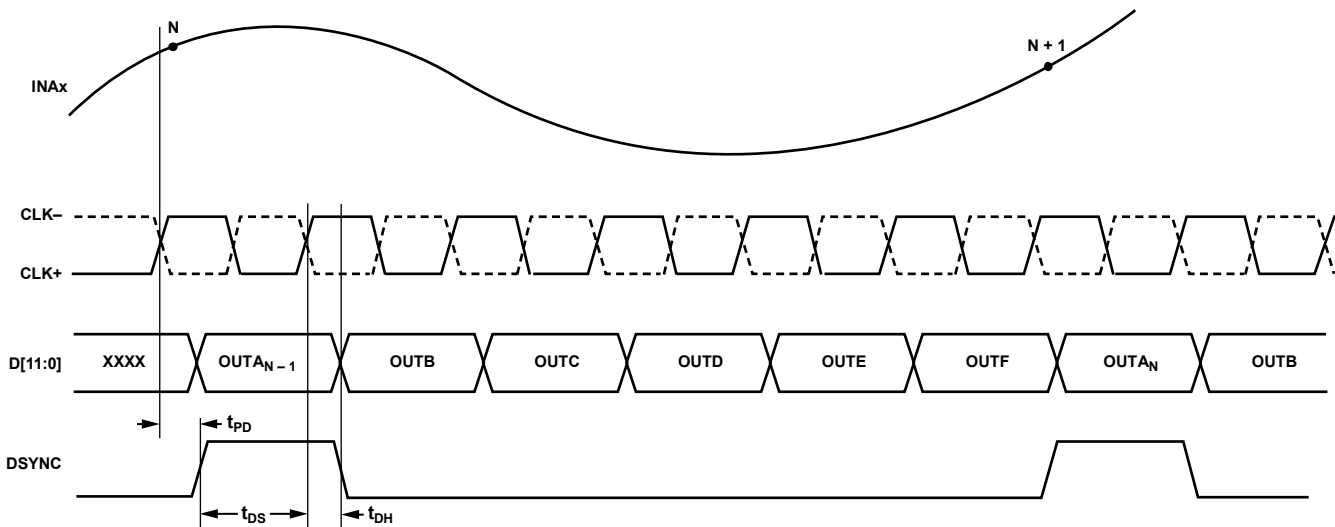

NOTES

1. FOR ABOVE CONFIGURATION REGISTER ADDRESS 0C SET TO 1010 (CHANNEL A, B, C, D, E AND F ENABLED).
2. DSYNC IS ALWAYS ALIGNED WITH CHANNEL A UNLESS CHANNEL A OR CHANNEL AUX IS THE ONLY CHANNEL SELECTED, IN WHICH CASE DSYNC IS NOT ACTIVE.
3. THERE IS A SEVEN CLOCK CYCLE LATENCY FROM SAMPLING A CHANNEL TO ITS DIGITAL DATA BEING PRESENT ON THE PARALLEL BUS PINS.

Figure 26. Data and DSYNC Timing

09795-006

ADC

The AD8283 uses a pipelined ADC architecture. The quantized output from each stage is combined into a 12-bit result in the digital correction logic. The pipelined architecture permits the first stage to operate on a new input sample and the remaining stages to operate on preceding samples. Sampling occurs on the rising edge of the clock. The output staging block aligns the data, corrects errors, and passes the data to the output buffers.

CLOCK INPUT CONSIDERATIONS

For optimum performance, the AD8283 sample clock inputs (CLK+ and CLK-) should be clocked with a differential signal. This signal is typically ac-coupled into the CLK+ and CLK- pins via a transformer or using capacitors. These pins are biased internally and require no additional bias.

Figure 27 shows the preferred method for clocking the AD8283. A low jitter clock source, such as the Valpey Fisher oscillator VFAC3-BHL-50MHz, is converted from single ended to differential using an RF transformer. The back-to-back Schottky diodes across the secondary transformer limit clock excursions into the AD8283 to approximately 0.8 V p-p differential. This helps prevent the large voltage swings of the clock from feeding through to other portions of the AD8283, and it preserves the fast rise and fall times of the signal, which are critical to low jitter performance.

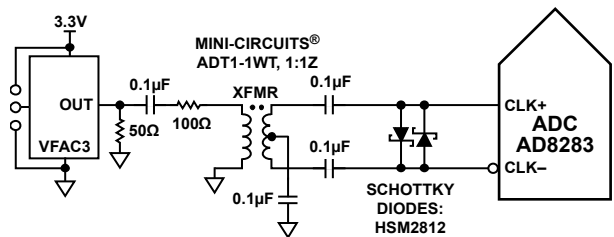
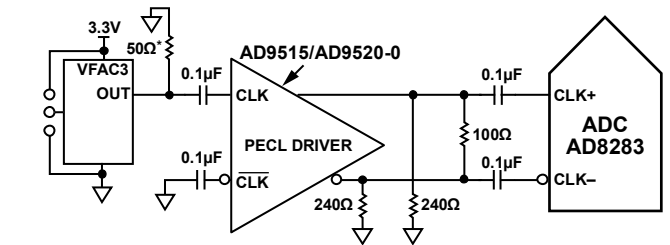

Figure 27. Transformer-Coupled Differential Clock

09795-007

If a low jitter clock is available, another option is to ac-couple a differential PECL or LVDS signal to the sample clock input pins as shown in and Figure 28 and Figure 29. The AD9515/AD9520-0 family of clock drivers offers excellent jitter performance.



*50Ω RESISTOR IS OPTIONAL.

Figure 28. Differential PECL Sample Clock

09795-008

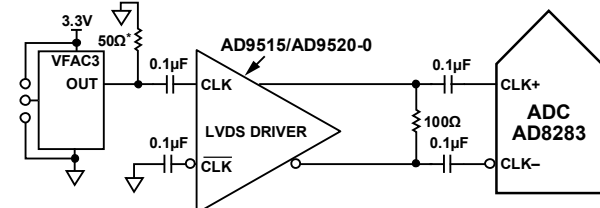

*50Ω RESISTOR IS OPTIONAL.

Figure 29. Differential LVDS Sample Clock

09795-009

In some applications, it is acceptable to drive the sample clock inputs with a single-ended CMOS signal. In such applications, CLK+ should be driven directly from a CMOS gate, and the CLK− pin should be bypassed to ground with a 0.1 μF capacitor in parallel with a 39 kΩ resistor (see Figure 30). Although the CLK+ input circuit supply is AVDD18, this input is designed to withstand input voltages of up to 3.3 V, making the selection of the drive logic voltage very flexible. The AD9515/AD9520-0 family of parts can be used to provide 3.3 V inputs (see Figure 31). In this case, 39 kΩ is not needed.

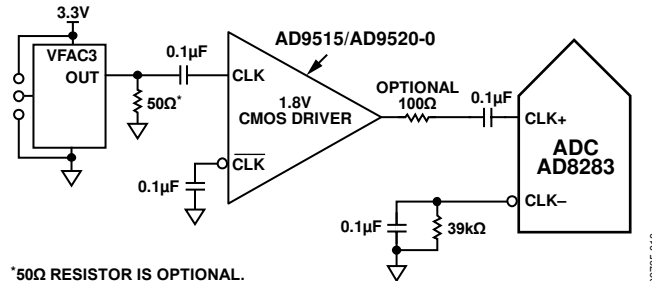

*50Ω RESISTOR IS OPTIONAL.

Figure 30. Single-Ended 1.8 V CMOS Sample Clock

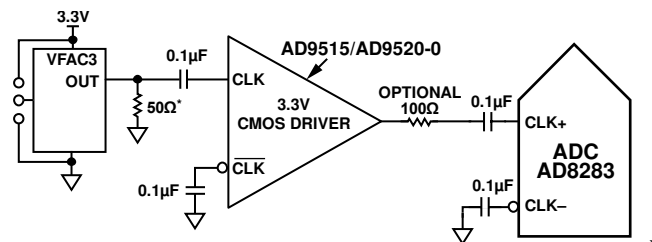

*50Ω RESISTOR IS OPTIONAL.

Figure 31. Single-Ended 3.3 V CMOS Sample Clock

CLOCK DUTY CYCLE CONSIDERATIONS

Typical high speed ADCs use both clock edges to generate a variety of internal timing signals. As a result, these ADCs may be sensitive to the clock duty cycle. Commonly, a 5% tolerance is required on the clock duty cycle to maintain dynamic performance characteristics. The AD8283 contains a duty cycle stabilizer (DCS) that retimes the nonsampling edge, providing an internal clock signal with a nominal 50% duty cycle. This allows a wide range of clock input duty cycles without affecting the performance of the AD8283.

When the DCS is on, noise and distortion performance are nearly flat for a wide range of duty cycles. However, some applications may require the DCS function to be off. If so, keep in mind that the dynamic range performance can be affected when operated in this mode. See Table 9 for more details on using this feature.

The duty cycle stabilizer uses a delay-locked loop (DLL) to create the nonsampling edge. As a result, any changes to the sampling frequency require approximately eight clock cycles to allow the DLL to acquire and lock to the new rate.

CLOCK JITTER CONSIDERATIONS

High speed, high resolution ADCs are sensitive to the quality of the clock input. The degradation in SNR at a given input frequency (f_A) due only to aperture jitter (t_j) can be calculated by

$$\text{SNR Degradation} = 20 \times \log_{10} [1/2 \times \pi \times f_A \times t_j]$$

In this equation, the RMS aperture jitter represents the root mean square of all jitter sources, including the clock input, analog input signal, and ADC aperture jitter. In undersampling applications are particularly sensitive to jitter.

The clock input should be treated as an analog signal in cases where aperture jitter may affect the dynamic range of the AD8283. Power supplies for clock drivers should be separated from the ADC output driver supplies to avoid modulating the clock signal with digital noise. Low jitter, crystal-controlled oscillators make the best clock sources, such as the Valpey Fisher VFAC3 series. If the clock is generated from another type of source (by gating, dividing, or other methods), it should be retimed by the original clock during the last step.

Refer to the AN-501 Application Note and the AN-756 Application Note for more in-depth information about how jitter performance relates to ADCs (visit www.analog.com).

SDIO PIN

The SDIO pin is required to operate the SPI. It has an internal 30 kΩ pull-down resistor that pulls this pin low and is only 1.8 V tolerant. If applications require that this pin be driven from a 3.3 V logic level, insert a 1 kΩ resistor in series with this pin to limit the current.

SCLK PIN

The SCLK pin is required to operate the SPI port interface. It has an internal 30 kΩ pull-down resistor that pulls this pin low and is both 1.8 V and 3.3 V tolerant.

CS PIN

The CS pin is required to operate the SPI port interface. It has an internal 70 kΩ pull-up resistor that pulls this pin high and is both 1.8 V and 3.3 V tolerant.

RBIAS PIN

To set the internal core bias current of the ADC, place a resistor nominally equal to 10.0 kΩ to ground at the RBIAS pin. Using other than the recommended 10.0 kΩ resistor for RBIAS degrades the performance of the device. Therefore, it is imperative that at least a 1.0% tolerance on this resistor be used to achieve consistent performance.

VOLTAGE REFERENCE

A stable and accurate 0.5 V voltage reference is built into the AD8283. This is gained up internally by a factor of 2, setting VREF to 1.0 V, which results in a full-scale differential input span of 2.0 V p-p for the ADC. VREF is set internally by default, but the VREF pin can be driven externally with a 1.0 V

reference to achieve more accuracy. However, this device does not support ADC full-scale ranges below 2.0 V p-p.

When applying the decoupling capacitors to the VREF pin, use ceramic low-ESR capacitors. These capacitors should be close to the reference pin and on the same layer of the PCB as the [AD8283](#). The VREF pin should have both a 0.1 μF capacitor and a 1 μF capacitor connected in parallel to the analog ground. These capacitor values are recommended for the ADC to properly settle and acquire the next valid sample.

POWER AND GROUND RECOMMENDATIONS

When connecting power to the [AD8283](#), it is recommended that two separate 1.8 V supplies and two separate 3.3 V supplies be used: one for analog 1.8 V (AVDD18x) and digital 1.8 V (DVDD18x) and one for analog 3.3 V (AVDD33x) and digital 3.3 V (DVDD33x). If only one supply is available for both analog and digital, for example, AVDD18x and DVDD18x, it should be routed to the AVDD18x first and then tapped off and isolated with a ferrite bead or a filter choke preceded by decoupling capacitors for the DVDD18x. The same is true for the analog and digital 3.3 V supplies. The user should employ several decoupling capacitors on all supplies to cover both high and low frequencies. These should be located close to the point of entry at the PC board level and close to the parts, with minimal trace lengths.

A single PC board ground plane should be sufficient when using the [AD8283](#). With proper decoupling and smart partitioning of the PC board's analog, digital, and clock sections, optimum performance can be achieved easily.

EXPOSED PADDLE THERMAL HEAT SLUG RECOMMENDATIONS

It is required that the exposed paddle on the underside of the device be connected to a quiet analog ground to achieve the best electrical and thermal performance of the [AD8283](#). An exposed continuous copper plane on the PCB should mate to the [AD8283](#) exposed paddle, Pin 0. The copper plane should have several vias to achieve the lowest possible resistive thermal path for heat dissipation to flow through the bottom of the PCB. These vias should be filled or plugged with nonconductive epoxy.

To maximize the coverage and adhesion between the device and PCB, partition the continuous copper pad by overlaying a silk-screen or solder mask to divide this into several uniform sections. This ensures several tie points between the two during the reflow process. Using one continuous plane with no partitions only guarantees one tie point between the [AD8283](#) and PCB. For more detailed information on packaging and for more PCB layout examples, see the [AN-772 Application Note](#).

SERIAL PERIPHERAL INTERFACE (SPI)

The AD8283 serial port interface allows the user to configure the signal chain for specific functions or operations through a structured register space provided inside the chip. This offers the user added flexibility and customization depending on the application. Addresses are accessed via the serial port and can be written to or read from via the port. Memory is organized into bytes that can be further divided into fields, as documented in the Memory Map section. Detailed operational information can be found in the Analog Devices, Inc., [AN-877 Application Note, Interfacing to High Speed ADCs via SPI](#).

There are three pins that define the serial port interface, or SPI. They are the SCLK, SDIO, and $\overline{\text{CS}}$ pins. The SCLK (serial clock) is used to synchronize the read and write data presented to the device. The SDIO (serial data input/output) is a dual-purpose pin that allows data to be sent to and read from the device's internal memory map registers. The $\overline{\text{CS}}$ (chip select bar) is an active low control that enables or disables the read and write cycles (see Table 7).

Table 7. Serial Port Pins

Pin	Function
SCLK	Serial clock. The serial shift clock input. SCLK is used to synchronize serial interface reads and writes.
SDIO	Serial data input/output. A dual-purpose pin. The typical role for this pin is as an input or output, depending on the instruction sent and the relative position in the timing frame.
$\overline{\text{CS}}$	Chip select bar (active low). This control gates the read and write cycles.

The falling edge of the $\overline{\text{CS}}$ in conjunction with the rising edge of the SCLK determines the start of the framing sequence. During an instruction phase, a 16-bit instruction is transmitted, followed by one or more data bytes, which is determined by Bit Field W0 and Bit Field W1. An example of the serial timing and its definitions can be found in Figure 32 and Table 8.

In normal operation, $\overline{\text{CS}}$ is used to signal to the device that SPI commands are to be received and processed. When $\overline{\text{CS}}$ is brought low, the device processes SCLK and SDIO to process instructions. Normally, $\overline{\text{CS}}$ remains low until the communication cycle is complete. However, if connected to a slow device, $\overline{\text{CS}}$ can be brought high between bytes, allowing older microcontrollers enough time to transfer data into shift registers. $\overline{\text{CS}}$ can be stalled when transferring one, two, or three bytes of data. When W0 and W1 are set to 11, the device enters streaming mode and continues to process data, either reading or writing, until $\overline{\text{CS}}$ is taken high to end the communication cycle. This allows complete memory transfers without having to provide additional instructions. Regardless of the mode, if $\overline{\text{CS}}$ is taken high in the middle of any byte transfer, the SPI state machine is reset and the device waits for a new instruction.

In addition to the operation modes, the SPI port can be configured to operate in different manners. For applications that do not require a control port, the $\overline{\text{CS}}$ line can be tied and held high. This places the remainder of the SPI pins in their secondary mode as defined in the SDIO Pin and SCLK Pin sections. $\overline{\text{CS}}$ can also be tied low to enable 2-wire mode. When $\overline{\text{CS}}$ is tied low, SCLK and SDIO are the only pins required for communication. Although the device is synchronized during power-up, caution must be exercised when using this mode to ensure that the serial port remains synchronized with the $\overline{\text{CS}}$ line. When operating in 2-wire mode, it is recommended to use a 1-, 2-, or 3-byte transfer exclusively. Without an active $\overline{\text{CS}}$ line, streaming mode can be entered but not exited.

In addition to word length, the instruction phase determines if the serial frame is a read or write operation, allowing the serial port to be used to both program the chip and read the contents of the on-chip memory. If the instruction is a readback operation, performing a readback causes the serial data input/output (SDIO) pin to change direction from an input to an output at the appropriate point in the serial frame.

Data can be sent in MSB- or LSB-first mode. MSB-first mode is the default at power-up and can be changed by adjusting the configuration register. For more information about this and other features, see the [AN-877 Application Note, Interfacing to High Speed ADCs via SPI](#).

HARDWARE INTERFACE

The pins described in Table 7 constitute the physical interface between the user's programming device and the serial port of the AD8283. The SCLK and $\overline{\text{CS}}$ pins function as inputs when using the SPI interface. The SDIO pin is bidirectional, functioning as an input during write phases and as an output during readback.

This interface is flexible enough to be controlled by either serial PROMS or PIC microcontrollers. This provides the user with an alternative method, other than a full SPI controller, for programming the device (see the [AN-812 Application Note](#)).

If the user chooses not to use the SPI interface, these pins serve a dual function and are associated with secondary functions when the $\overline{\text{CS}}$ is strapped to AVDD during device power-up. See the SDIO Pin and SCLK Pin sections for details on which pin-strappable functions are supported on the SPI pins.

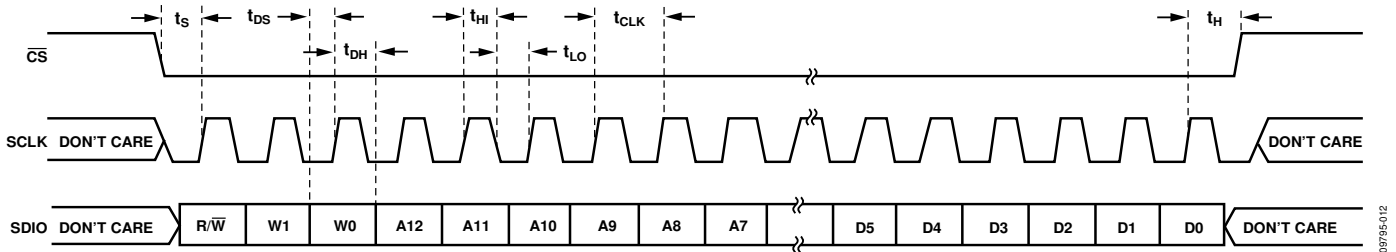

Figure 32. Serial Timing Details

Table 8. Serial Timing Definitions

Parameter	Minimum Timing (ns)	Description
t_{DS}	5	Setup time between the data and the rising edge of SCLK
t_{DH}	2	Hold time between the data and the rising edge of SCLK
t_{CLK}	40	Period of the clock
t_s	5	Setup time between \overline{CS} and SCLK
t_H	2	Hold time between \overline{CS} and SCLK
t_{HI}	16	Minimum period that SCLK should be in a logic high state
t_{LO}	16	Minimum period that SCLK should be in a logic low state
t_{EN_SDIO}	10	Minimum time for the SDIO pin to switch from an input to an output relative to the SCLK falling edge (not shown in Figure 32).
t_{DIS_SDIO}	10	Minimum time for the SDIO pin to switch from an output to an input relative to the SCLK rising edge (not shown in Figure 32)

MEMORY MAP

READING THE MEMORY MAP TABLE

Each row in the memory map table has eight address locations. The memory map is roughly divided into three sections: the chip configuration registers map (Address 0x00 and Address 0x01), the device index and transfer registers map (Address 0x04 to Address 0xFF), and the ADC channel functions registers map (Address 0x08 to Address 0x2C).

The leftmost column of the memory map indicates the register address number, and the default value is shown in the second rightmost column. The Bit 7 (MSB) column is the start of the default hexadecimal value given. For example, Address 0x09, the clock register, has a default value of 0x01, meaning that Bit 7 = 0, Bit 6 = 0, Bit 5 = 0, Bit 4 = 0, Bit 3 = 0, Bit 2 = 0, Bit 1 = 0, and Bit 0 = 1, or 0000 0001 in binary. This setting is the default for the duty cycle stabilizer in the on condition. By writing a 0 to Bit 0 of this address followed by an 0x01 to the SW transfer bit in Register 0xFF, the duty cycle stabilizer turns off. It is important to follow each writing sequence with a write to the SW transfer bit to update the SPI registers.

Note that all registers except Register 0x00, Register 0x04, Register 0x05, and Register 0xFF are buffered with a master slave latch and require writing to the transfer bit. For more information on this and other functions, consult the [AN-877 Application Note](#), *Interfacing to High Speed ADCs via SPI*.

LOGIC LEVELS

An explanation of various registers follows: “bit is set” is synonymous with “bit is set to Logic 1” or “writing Logic 1 for the bit.” Similarly, “clear a bit” is synonymous with “bit is set to Logic 0” or “writing Logic 0 for the bit.”

RESERVED LOCATIONS

Undefined memory locations should not be written to except when writing the default values suggested in this data sheet. Addresses that have values marked as 0 should be considered reserved and have a 0 written into their registers during power-up.

DEFAULT VALUES

After a reset, critical registers are automatically loaded with default values. These values are indicated in Table 9, where an X refers to an undefined feature.

Table 9. AD8283 Memory Map Register

Addr. (Hex)	Register Name	Bit 7 (MSB)	Bit 6	Bit 5	Bit 4	Bit 3	Bit 2	Bit 1	Bit 0 (LSB)	Default Value	Default Notes/ Comments
Chip Configuration Registers											
00	CHIP_PORT_CONFIG	0	LSB first 1 = on 0 = off (default)	Soft reset 1 = on 0 = off (default)	1	1	Soft reset 1 = on 0 = off (default)	LSB first 1 = on 0 = off (default)	0	0x18	The nibbles should be mirrored so that LSB- or MSB-first mode is set correct regardless of shift mode.
01	CHIP_ID	Chip ID Bits[7:0] (AD8283 = 0xA2, default)								Read only	The default is a unique chip ID, specific to the AD8283. This is a read-only register.
Device Index and Transfer Registers											
04	DEVICE_INDEX_2	X	X	X	X	X	X	Data Channel F 1 = on (default) 0 = off	Data Channel E 1 = on (default) 0 = off	0x0F	Bits are set to determine which on-chip device receives the next write command.
05	DEVICE_INDEX_1	X	X	X	X	Data Channel D 1 = on (default) 0 = off	Data Channel C 1 = on (default) 0 = off	Data Channel B 1 = on (default) 0 = off	Data Channel A 1 = on (default) 0 = off	0x0F	Bits are set to determine which on-chip device receives the next write command.
FF	DEVICE_UPDATE	X	X	X	X	X	X	X	SW transfer 1 = on 0 = off (default)	0x00	Synchronously transfers data from the master shift register to the slave.
Channel Functions Registers											
08	GLOBAL_MODES	X	X	X	X	X	X	Internal power-down mode 00 = chip run (default) 01 = full power-down 11 = reset		0x00	Determines the power-down mode (global).
09	GLOBAL_CLOCK	X	X	X	X	X	X	X	Duty cycle stabilizer 1 = on (default) 0 = off	0x01	Turns the internal duty cycle stabilizer on and off (global).
0C	FLEX_MUX_CONTROL	X	Power-down of unused channels 0 = PD (power-down; default) 1 = power-on	X	X	Mux input active channels 0000 = A 0001 = A Aux 0010 = AB 0011 = A Aux 0100 = ABC 0101 = AB Aux 0110 = ABCD 0111 = ABC Aux 1000 = ABCDE 1001 = ABCD Aux 1010 = ABCDEF 1011 = ABCDE Aux			0x00	Sets which mux input channel(s) are in use and whether to power down unused channels.	

Addr. (Hex)	Register Name	Bit 7 (MSB)	Bit 6	Bit 5	Bit 4	Bit 3	Bit 2	Bit 1	Bit 0 (LSB)	Default Value	Default Notes/Comments
0D	FLEX_TEST_IO	User test mode 00 = off (default) 01 = on, single alternate 10 = on, single once 11 = on, alternate once		Reset PN long gen 1 = on 0 = off (default)	Reset PN short gen 1 = on 0 = off (default)	Output test mode—see Table 10 0000 = off (default) 0001 = midscale short 0010 = +FS short 0011 = -FS short 0100 = checkerboard output 0101 = PN sequence long 0110 = PN sequence short 0111 = one-/zero-word toggle 1000 = user input 1001 = 1-/0-bit toggle 1010 = 1× sync 1011 = one bit high 1100 = mixed bit frequency (format determined by the OUTPUT_MODE register)				0x00	When this register is set, the test data is placed on the output pins in place of normal data. (Local, except for PN sequence.)
0F	FLEX_CHANNEL_INPUT	Filter cutoff frequency control 0000 = $1.3 \times 1/4 \times f_{\text{SAMPLECH}}$ 0001 = $1.2 \times 1/4 \times f_{\text{SAMPLECH}}$ 0010 = $1.1 \times 1/4 \times f_{\text{SAMPLECH}}$ 0011 = $1.0 \times 1/4 \times f_{\text{SAMPLECH}}$ (default) 0100 = $0.9 \times 1/4 \times f_{\text{SAMPLECH}}$ 0101 = $0.8 \times 1/4 \times f_{\text{SAMPLECH}}$ 0110 = $0.7 \times 1/4 \times f_{\text{SAMPLECH}}$ 0111 = N/A 1000 = $1.3 \times 1/3 \times f_{\text{SAMPLECH}}$ 1001 = $1.2 \times 1/3 \times f_{\text{SAMPLECH}}$ 1010 = $1.1 \times 1/3 \times f_{\text{SAMPLECH}}$ 1011 = $1.0 \times 1/3 \times f_{\text{SAMPLECH}}$ 1100 = $0.9 \times 1/3 \times f_{\text{SAMPLECH}}$ 1101 = $0.8 \times 1/3 \times f_{\text{SAMPLECH}}$ 1110 = $0.7 \times 1/3 \times f_{\text{SAMPLECH}}$ 1111 = N/A				X	X	X	X	0x30	Low pass filter cutoff (global). f_{SAMPLECH} = ADC sample rate/ number of active channels. Note that the absolute range is limited to 1 MHz to 12 MHz.
10	FLEX_OFFSET	X	X	6-bit LNA offset adjustment 00 0000 for LNA bias high 01 1111 for LNA mid-high 10 0000 for LNA mid-low (default) 11 1111 for LNA bias low						0x20	LNA force offset correction (local).
11	FLEX_GAIN_1	X	X	X	X	X	010 = 16 dB (default) 011 = 22 dB 100 = 28 dB 101 = 34 dB			0x00	Total LNA + PGA gain adjustment (local)
12	FLEX_BIAS_CURRENT	X	X	X	X	X	X	LNA bias 00 = high 01 = mid-high (default) 10 = mid-low 11 = low		0x09	LNA bias current adjustment (global).
14	FLEX_OUTPUT_MODE	X	X	X	X	X	1 = output invert (local)	0 = offset binary (default) 1 = twos complement (global)		0x00	Configures the outputs and the format of the data.
15	FLEX_OUTPUT_ADJUST	0 = enable Data Bits [11:0] 1 = disable Data Bits [11:0]	X	X	X	Typical output rise time and fall time, respectively 00 = 2.6 ns, 3.4 ns 01 = 1.1 ns, 1.6 ns 10 = 0.7 ns, 0.9 ns 11 = 0.7 ns, 0.7 ns (default)		Typical output drive strength 00 = 45 mA 01 = 30 mA 10 = 60 mA 11 = 60 mA (default)		0x0F	Used to adjust output rise and fall times and select output drive strength, limiting the noise added to the channels by output switching.

Addr. (Hex)	Register Name	Bit 7 (MSB)	Bit 6	Bit 5	Bit 4	Bit 3	Bit 2	Bit 1	Bit 0 (LSB)	Default Value	Default Notes/Comments
18	FLEX_VREF	X	0 = internal reference 1 = external reference	X	X	X	X	00 = 0.625 V 01 = 0.750 V 10 = 0.875 V 11 = 1.024 V (default)		0x03	Select internal reference (recommended default) or external reference (global); adjust internal reference.
19	FLEX_USER_PATT1_LSB	B7	B6	B5	B4	B3	B2	B1	B0	0x00	User-defined pattern, 1 LSB.
1A	FLEX_USER_PATT1_MSB	B15	B14	B13	B12	B11	B10	B9	B8	0x00	User-defined pattern, 1 MSB.
1B	FLEX_USER_PATT2_LSB	B7	B6	B5	B4	B3	B2	B1	B0	0x00	User-defined pattern, 2 LSBs.
1C	FLEX_USER_PATT2_MSB	B15	B14	B13	B12	B11	B10	B9	B8	0x00	User-defined pattern, 2 MSBs.
2B	FLEX_FILTER	X	Enable automatic low-pass tuning 1 = on (self-clearing)	X	X					0x00	
2C	CH_IN_IMP	X	X	X	X	X	X		0 = 200Ω (default) 1 = 200kΩ	0x00	Input impedance adjustment (global).

Table 10. Flexible Output Test Modes

Output Test Mode Bit Sequence	Pattern Name	Digital Output Word 1	Digital Output Word 2	Subject to Data Format Select
0000	Off (default)	N/A	N/A	N/A
0001	Midscale short	1000 0000 0000	Same	Yes
0010	+Full-scale short	1111 1111 1111	Same	Yes
0011	–Full-scale short	0000 0000 0000	Same	Yes
0100	Checkerboard output	1010 1010 1010	0101 0101 0101	No
0101	PN sequence long	N/A	N/A	Yes
0110	PN sequence short	N/A	N/A	Yes
0111	One-/zero-word toggle	1111 1111 1111	0000 0000 0000	No
1000	User input	Register 0x19 to Register 0x1A	Register 0x1B to Register 0x1C	No
1001	1-/0-bit toggle	1010 1010 1010	N/A	No
1010	1× sync	0000 0011 1111	N/A	No
1011	One bit high	1000 0000 0000	N/A	No
1100	Mixed bit frequency	1010 0011 0011	N/A	No

APPLICATION DIAGRAMS

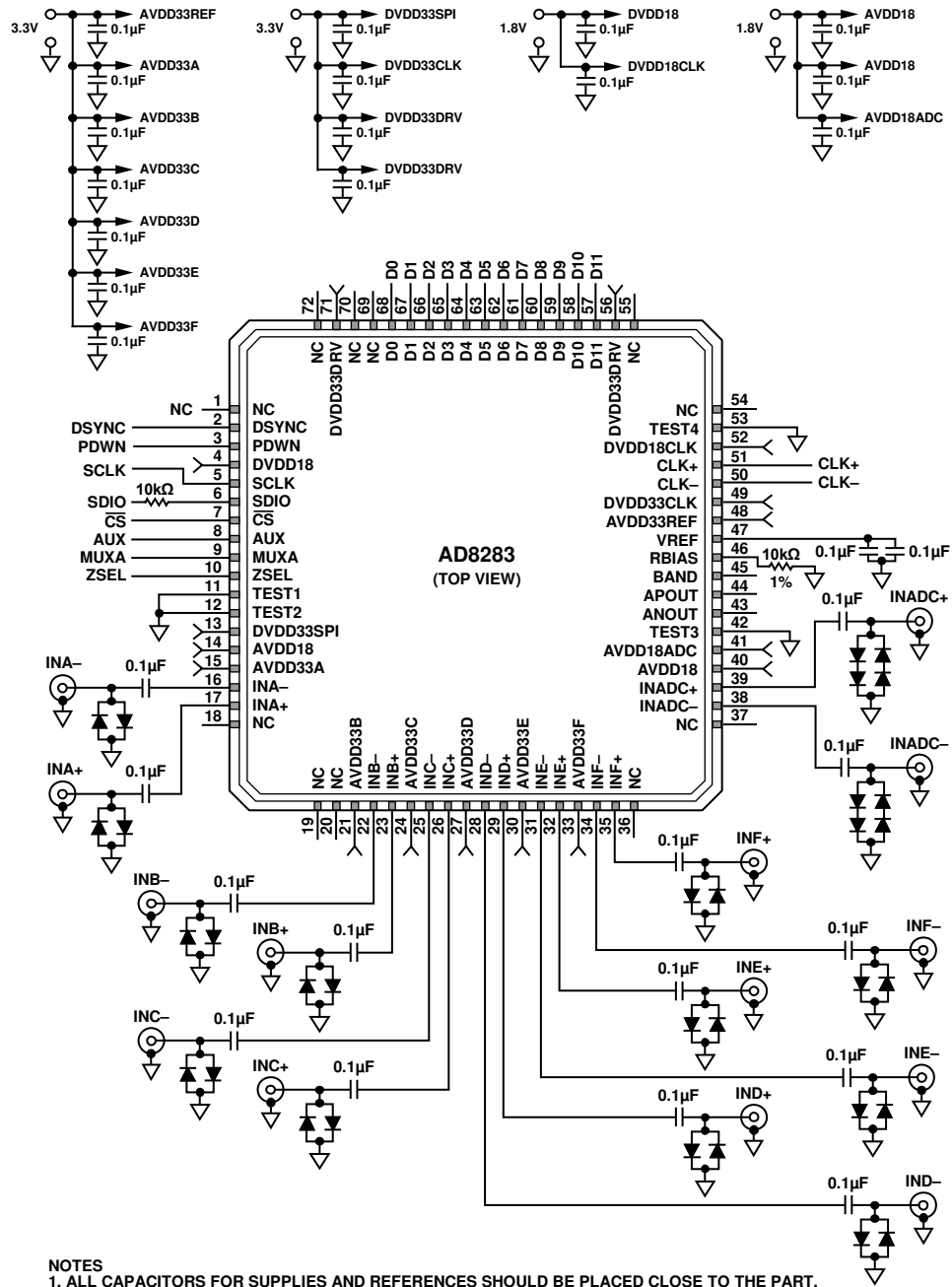
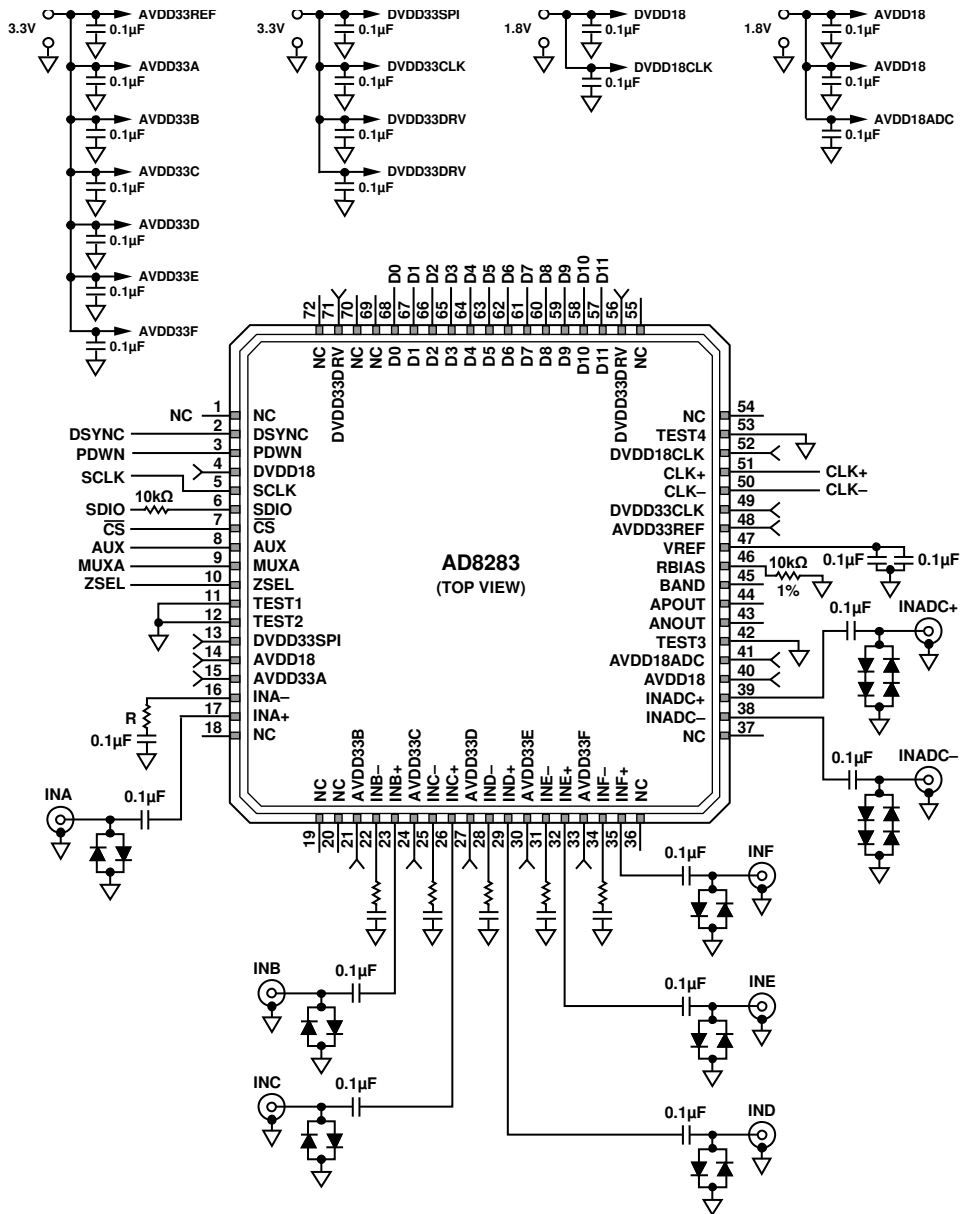

Figure 33. Differential Inputs



- NOTES**
1. RESISTOR R (IN_x- INPUTS) SHOULD MATCH THE OUTPUT IMPEDANCE OF THE INPUT DRIVER.
 2. ALL CAPACITORS FOR SUPPLIES AND REFERENCES SHOULD BE PLACED CLOSE TO THE PART.

Figure 34. Single-Ended Inputs

09795-029

OUTLINE DIMENSIONS

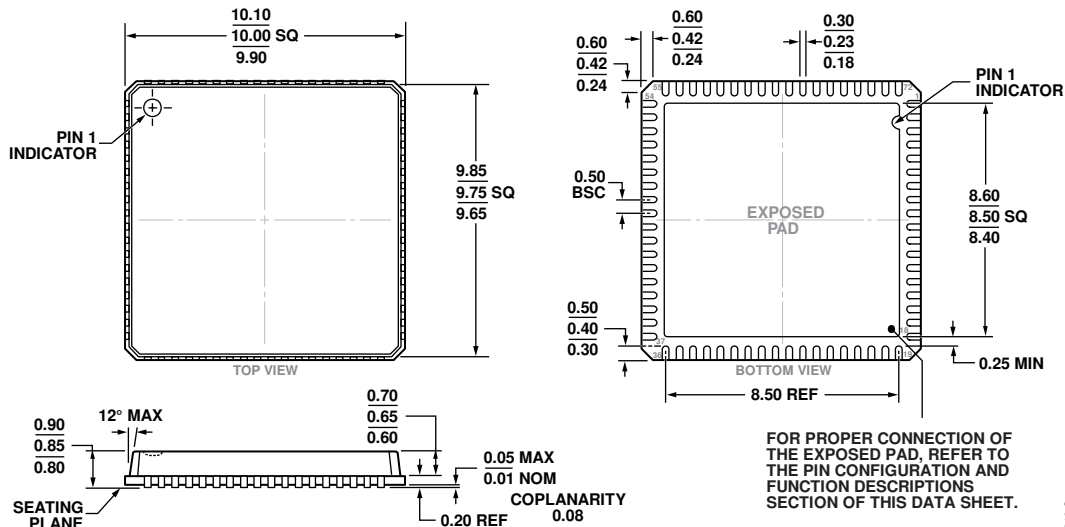

COMPLIANT TO JEDEC STANDARDS MO-220-VNND-4

Figure 35. 72-Lead Lead Frame Chip Scale Package [LFCSP_VQ]
10 mm × 10 mm Body, Very Thin Quad
(CP-72-5)
Dimensions shown in millimeters

11-06-2013-C

ORDERING GUIDE

Model ^{1, 2, 3}	Temperature Range	Package Description	Package Option
AD8283WBCPZ-RL	-40°C to +105°C	72-Lead LFCSP_VQ, 13" Tape and Reel	CP-72-5
AD8283WBCPZ	-40°C to +105°C	72-Lead LFCSP_VQ, Waffle Pack	CP-72-5
AD8283CP-EBZ		Evaluation Board	

¹ Z = RoHS Compliant Part.

² W = Qualified for Automotive Applications.

³ Compliant to JEDEC Standard MO-220-VNND-4.

AUTOMOTIVE PRODUCTS

The [AD8283WBCPZ](#) models are available with controlled manufacturing to support the quality and reliability requirements of automotive applications. Note that these automotive models may have specifications that differ from the commercial models; therefore, designers should review the Specifications section of this data sheet carefully. Only the automotive grade products shown are available for use in automotive applications. Contact your local Analog Devices account representative for specific product ordering information and to obtain the specific Automotive Reliability reports for this model.