

NH033x-L and NH050x-L Series Power Modules: 5 Vdc Input; 1.2 Vdc to 3.3 Vdc Output; 10 A and 15 A

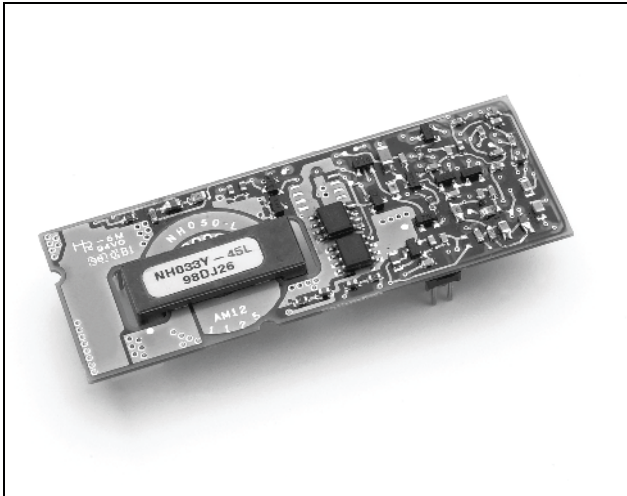

The NH033x-L and NH050x-L Series Power Modules use advanced, surface-mount technology and deliver high-quality, compact, dc-dc conversion at an economical price.

Applications

- Distributed power architectures
- Servers
- Workstations
- Desktop computers

Description

The NH033x-L and NH050x-L Series Power Modules are non-isolated dc-dc converters that operate over an input voltage range of 4.5 Vdc to 5.5 Vdc and provide a regulated output between 1.2 V and 3.3 V. The open frame power modules have a maximum output current rating of 10 A and 15 A, respectively, at typical full-load efficiencies of 91%.

Features

- Small size: 69.9 mm x 25.4 mm x 8.6 mm (2.75 in. x 1.00 in. x 0.34 in.)
- Non-isolated output
- Constant frequency
- High efficiency: 91% typical
- Overcurrent protection
- Remote on/off
- Output voltage adjustment:
90% to 110% of $V_{O, nom}$: $V_O \geq 2.5$ V
100% to 120% of $V_{O, nom}$: $V_O < 2.5$ V
- Overtemperature protection
- Remote sense
- *UL** 60950 Recognized, *CSA*† C22.2 No. 60950-00 Certified, VDE 0805 (IEC60950) Licensed
- Meets FCC Class A radiated limits

Options

- Tight tolerance output
- Short pins: 2.79 mm \pm 0.25 mm (0.110 in. \pm 0.010 in.)

* *UL* is a registered trademark of Underwriters Laboratories, Inc.

† *CSA* is a registered trademark of Canadian Standards Association.

Absolute Maximum Ratings

Stresses in excess of the absolute maximum ratings can cause permanent damage to the device. These are absolute stress ratings only. Functional operation of the device is not implied at these or any other conditions in excess of those given in the operations sections of the data sheet. Exposure to absolute maximum ratings for extended periods can adversely affect device reliability.

Parameter	Device	Symbol	Min	Max	Unit
Input Voltage (continuous)	All	V_I	—	7.0	Vdc
On/Off Terminal Voltage	All	$V_{on/off}$	—	6.0	Vdc
Operating Ambient Temperature*: NH033x-L	All	T_A	0	62	°C
NH050x-L	All	T_A	0	49	°C
Storage Temperature	All	T_{stg}	-55	125	°C

* Forced convection—200 lfpm minimum. Higher ambient temperatures possible with increased airflow and/or decreased power output. See the Thermal Considerations section for more details.

Electrical Specifications

Unless otherwise indicated, specifications apply over all operating input voltage, resistive load, and temperature conditions.

Table 1. Input Specifications

Parameter	Symbol	Min	Typ	Max	Unit
Operating Input Voltage: Start-up	V_I	4.75	—	—	Vdc
Continuous Operation	V_I	4.5	5.0	5.5	Vdc
Maximum Input Current ($V_I = 0$ V to 5.5 V; $I_O = I_{O, max}$; see Figures 1—8.): NH033x-L	$I_{I, max}$	—	—	10	A
NH050x-L	$I_{I, max}$	—	—	16	A
Input Reflected-ripple Current, Peak-to-peak (5 Hz to 20 MHz, 500 nH source impedance; see Figure 33.)	I_I	—	300	—	mAp-p
Input Ripple Rejection (120 Hz)	—	—	60	—	dB

Fusing Considerations

CAUTION: This power module is not internally fused. An input line fuse must always be used.

This power module can be used in a wide variety of applications, ranging from simple stand-alone operation to an integrated part of a sophisticated power architecture. To preserve maximum flexibility, internal fusing is not included; however, to achieve maximum safety and system protection, always use an input line fuse. The safety agencies require a normal-blow fuse with a maximum rating of 20 A (see Safety Considerations section). Based on the information provided in this data sheet on inrush energy and maximum dc input current, the same type of fuse with a lower rating can be used. Refer to the fuse manufacturer's data for further information.

Electrical Specifications (continued)

Table 2. Output Specifications

Parameter	Device	Symbol	Min	Typ	Max	Unit
Output Voltage Set Point ($V_I = 5.0\text{ V}$; $I_O = I_{O, \text{max}}$; $T_A = 25\text{ }^\circ\text{C}$)	NH0xxM-L	$V_{O, \text{set}}$	1.45	1.5	1.55	Vdc
	NH0xxS1R8-L	$V_{O, \text{set}}$	1.74	1.8	1.86	Vdc
	NH0xxG-L	$V_{O, \text{set}}$	2.42	2.5	2.58	Vdc
	NH0xxF-L	$V_{O, \text{set}}$	3.18	3.3	3.39	Vdc
Output Voltage (Over all operating input voltage, resistive load, and temperature conditions until end of life; see Figure 35.)	NH0xxM-L	V_O	1.43	—	1.58	Vdc
	NH0xxS1R8-L	V_O	1.71	—	1.89	Vdc
	NH0xxG-L	V_O	2.40	—	2.60	Vdc
	NH0xxF-L	V_O	3.16	—	3.44	Vdc
Output Regulation: Line ($V_I = 4.5\text{ V}$ to 5.5 V) Load ($I_O = 0$ to $I_{O, \text{max}}$) Temperature ($T_A = 0\text{ }^\circ\text{C}$ to $50\text{ }^\circ\text{C}$)	All	—	—	0.1	0.3	% V_O
	All	—	—	0.1	0.3	% V_O
	All	—	—	—	17	mV
Output Ripple and Noise Voltage (See Figure 34.): RMS Peak-to-peak (5 Hz to 20 MHz)	All	—	—	—	25	mVrms
	All	—	—	—	100	mVp-p
External Load Capacitance (See Design Considerations section.)	All	—	0	—	15,000	μF
Output Current (See Derating Curves Figures 50 and 51.)	NH033x-L	I_O	0	—	10.0	A
	NH050x-L	I_O	0	—	15.0	A
Output Current-limit Inception ($V_O = 90\%$ of $V_{O, \text{set}}$; $T_{Q32} = 80\text{ }^\circ\text{C}$; see Feature Descriptions section.)	All	I_O	103	—	200	% $I_{O, \text{max}}$
Output Short-circuit Current	All	I_O	—	170	—	% $I_{O, \text{max}}$
Efficiency ($V_I = 5.0\text{ V}$; $I_O = I_{O, \text{max}}$; $T_A = 25\text{ }^\circ\text{C}$; see Figure 35.)	NH033M-L	η	80	83	—	%
	NH033S1R8-L	η	82	85	—	%
	NH033G-L	η	87	89	—	%
	NH033F-L	η	90	92	—	%
	NH050M-L	η	77	81	—	%
	NH050S1R8-L	η	81	83	—	%
	NH050G-L	η	85	87	—	%
	NH050F-L	η	89	90.5	—	%
Switching Frequency	All	—	—	265	—	kHz
Dynamic Response ($\Delta I_O/\Delta t = 1\text{ A}/10\text{ }\mu\text{s}$, $V_I = 5.0\text{ V}$, $T_A = 25\text{ }^\circ\text{C}$): Load Change from $I_O = 0\%$ to 100% of $I_{O, \text{max}}$: Peak Deviation Settling Time ($V_O < 10\%$ peak deviation) Load Change from $I_O = 100\%$ to 0% of $I_{O, \text{max}}$: Peak Deviation Settling Time ($V_O < 10\%$ peak deviation)	All	—	—	20	—	mV
	All	—	—	200	—	μs
	All	—	—	20	—	mV
	All	—	—	200	—	μs

General Specifications

Parameter	Min	Typ	Max	Unit
Calculated MTBF ($I_o = 80\%$ of $I_{o, max}$; $T_A = 40\text{ }^\circ\text{C}$)	1,300,000			hours
Weight	—	—	14 (0.5)	g (oz.)

Cleanliness Requirements

The open frame (no case or potting) power modules meet specification J-STD-001B. These requirements state that any solder balls must be attached and their size should not compromise the minimum electrical spacing of the power module.

The cleanliness designator of the open frame power module is C00 (per J specification).

Feature Specifications

Unless otherwise indicated, specifications apply over all operating input voltage, resistive load, and temperature conditions. See Feature Descriptions and Design Considerations sections for further information.

Parameter	Symbol	Min	Typ	Max	Unit
Remote On/Off Signal Interface ($V_i = 4.5\text{ V}$ to 5.5 V ; open collector pnp transistor or equivalent; signal referenced to GND pin; see Figure 38 and Feature Descriptions section.): Logic Low (ON/OFF pin open)—Module On: $I_{on/off} = 0.0\text{ }\mu\text{A}$ $V_{on/off} = 0.3\text{ V}$ Logic High ($V_{on/off} > 2.8\text{ V}$)—Module Off: $I_{on/off} = 10\text{ mA}$ $V_{on/off} = 5.5\text{ V}$ Turn-on Time ($I_o = I_{o, max}$; V_o within $\pm 1\%$ of steady state; see Figures 25—32.)	$V_{on/off}$ $I_{on/off}$ $V_{on/off}$ $I_{on/off}$ —	-0.7 — — — —	— — — — 3.0	0.3 50 6.0 10 —	V μA V mA ms
Output Voltage Adjustment* (See Feature Descriptions section.): Output Voltage Remote-sense Range: For $V_o \geq 2.5\text{ V}$ For $V_o < 2.5\text{ V}$ Output Voltage Set-point Adjustment Range (Trim): For $V_o \geq 2.5\text{ V}$ For $V_o < 2.5\text{ V}$	— — V_{TRIM} V_{TRIM}	— — 90 100	— — — —	10 20 110 120	% $V_{O, nom}$ % $V_{O, nom}$ % $V_{O, nom}$ % $V_{O, nom}$
Overtemperature Protection (shutdown) (See Feature Descriptions section.)	T_{Q32}	115	120	—	$^\circ\text{C}$

* Total adjustment of trim and remote sense combined should not exceed 10% for $V_o \geq 2.5\text{ V}$ or 20% for $V_o < 2.5\text{ V}$.

Characteristics Curves

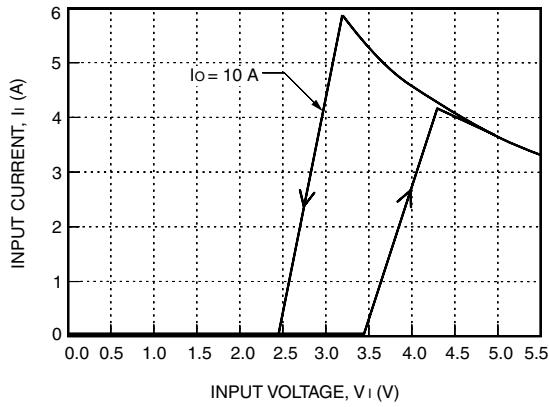

Figure 1. NH033M-L Input Characteristics,
 $T_A = 25\text{ }^\circ\text{C}$

8-2415

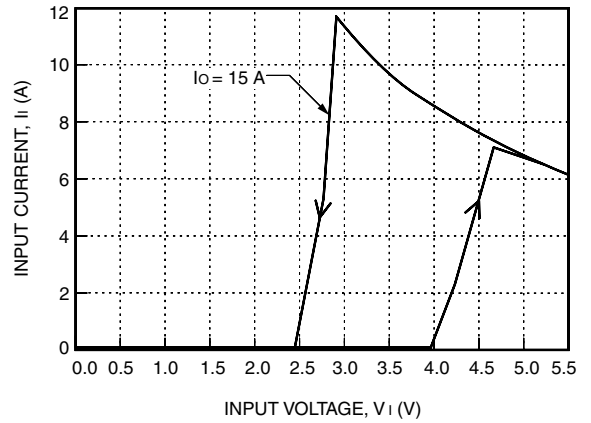

Figure 4. NH050S1R8-L Input Characteristics,
 $T_A = 25\text{ }^\circ\text{C}$

8-2420

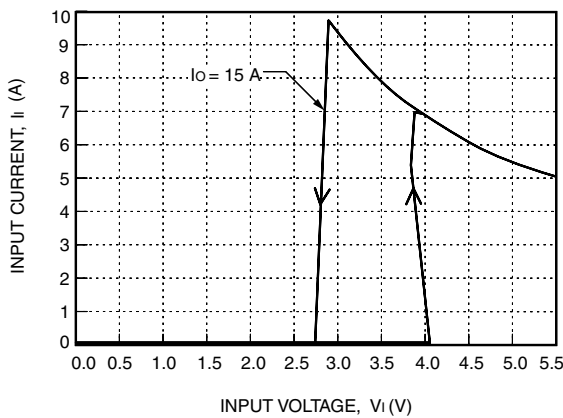

Figure 2. NH050M-L Input Characteristics,
 $T_A = 25\text{ }^\circ\text{C}$

8-2419

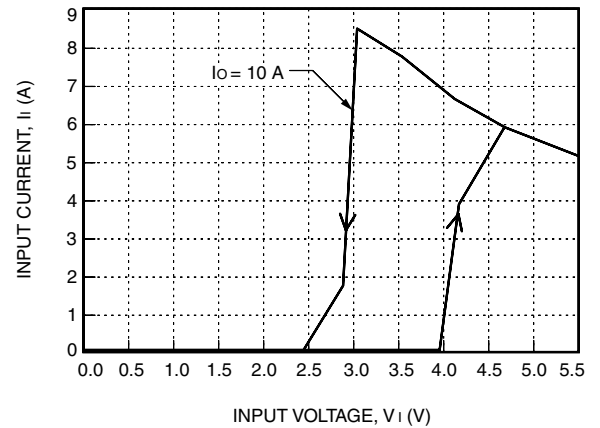

Figure 5. NH033G-L Input Characteristics,
 $T_A = 25\text{ }^\circ\text{C}$

8-2414

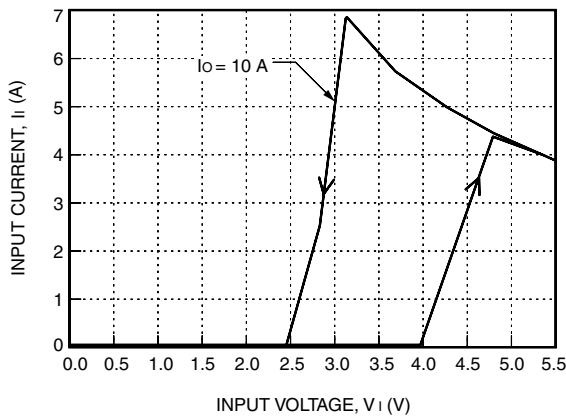

Figure 3. NH033S1R8-L Input Characteristics,
 $T_A = 25\text{ }^\circ\text{C}$

8-2416

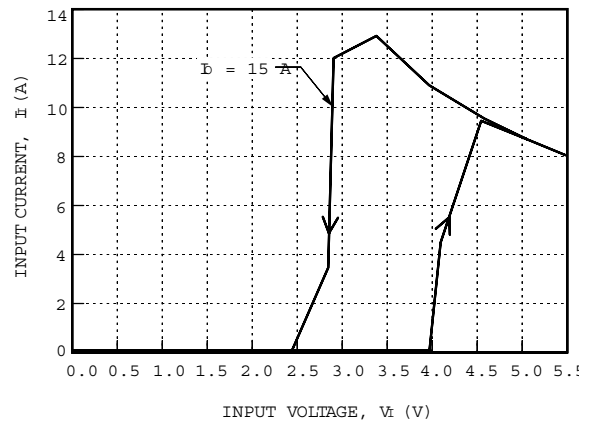
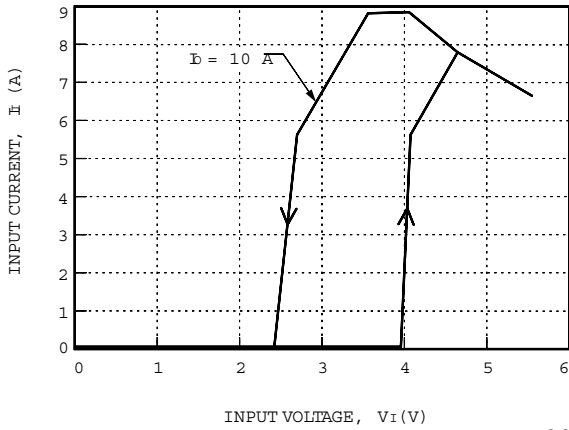

Figure 6. NH050G-L Input Characteristics,
 $T_A = 25\text{ }^\circ\text{C}$

8-2418

Characteristics Curves (continued)



8-2413(C)

Figure 7. NH033F-L Input Characteristics, TA = 25 °C

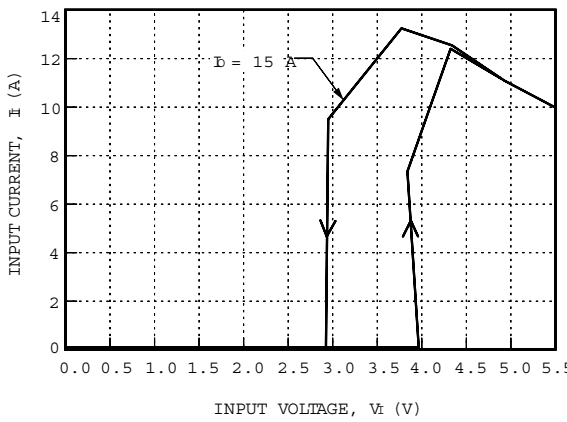

8-2417(C)

Figure 8. NH050F-L Input Characteristics, TA = 25 °C

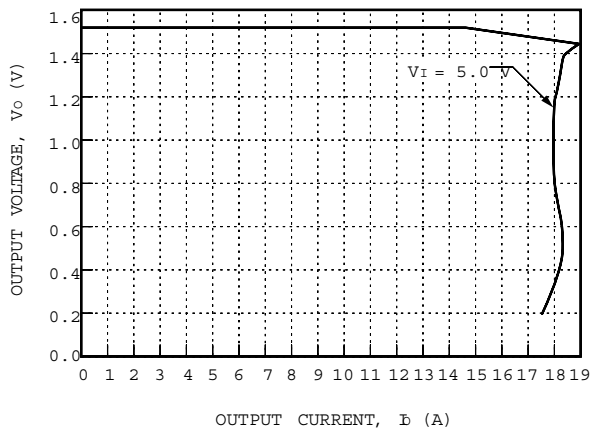

8-2423(C)

Figure 9. NH033M-L Current Limit, TA = 25 °C

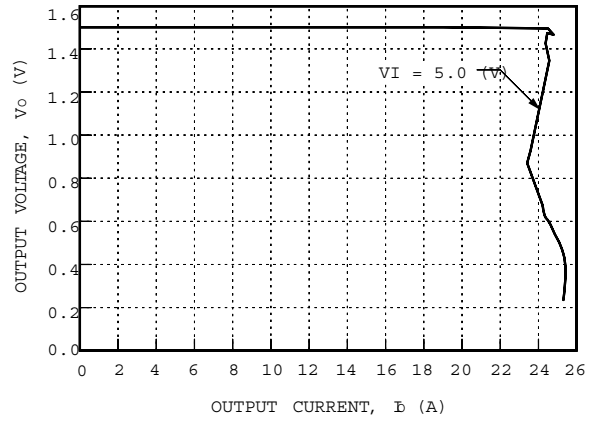

8-2427(C)

Figure 10. NH050M-L Current Limit, TA = 25 °C

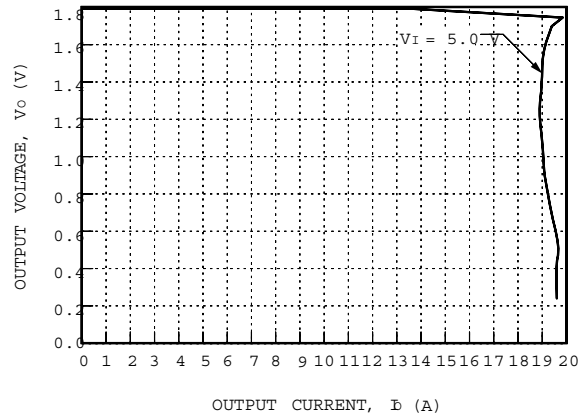

8-2424(C)

Figure 11. NH033S1R8-L Current Limit, TA = 25 °C

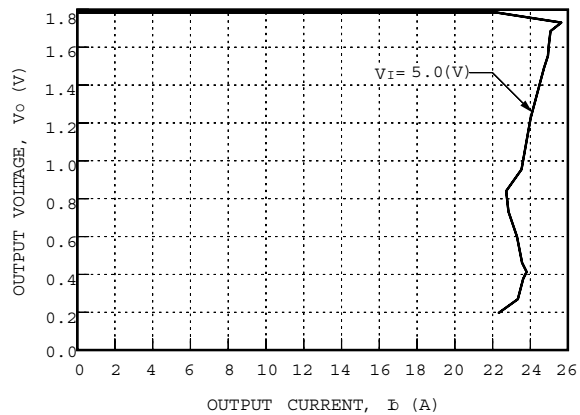

8-2428(C)

Figure 12. NH050S1R8-L Current Limit, TA = 25 °C

Characteristics Curves (continued)

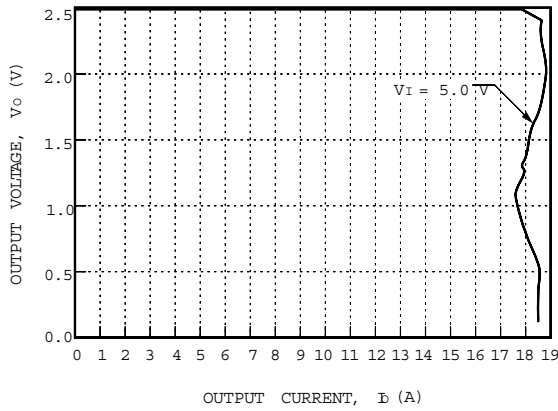

8-2422(C)

Figure 13. NH033G-L Current Limit, $T_A = 25\text{ }^\circ\text{C}$

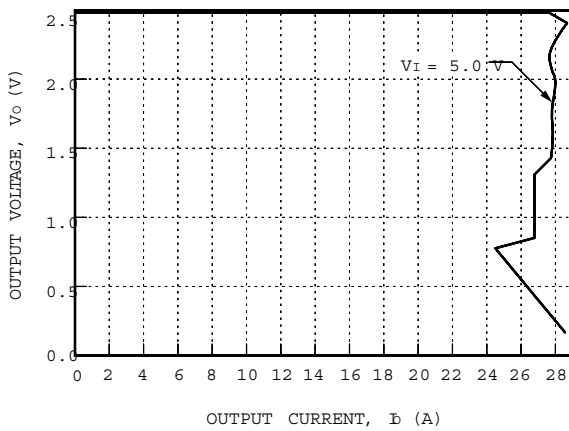

8-2426(C)

Figure 14. NH050G-L Current Limit, $T_A = 25\text{ }^\circ\text{C}$

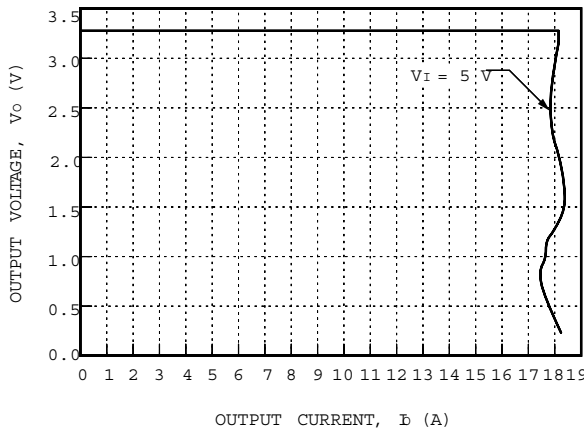

8-2421(C)

Figure 15. NH033F-L Current Limit, $T_A = 25\text{ }^\circ\text{C}$

Lineage Power

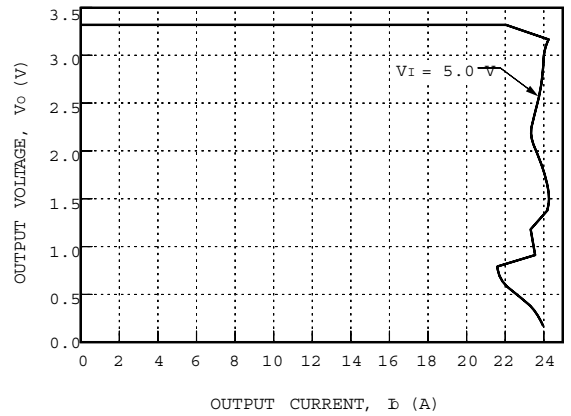

8-2425(C)

Figure 16. NH050F-L Current Limit, $T_A = 25\text{ }^\circ\text{C}$

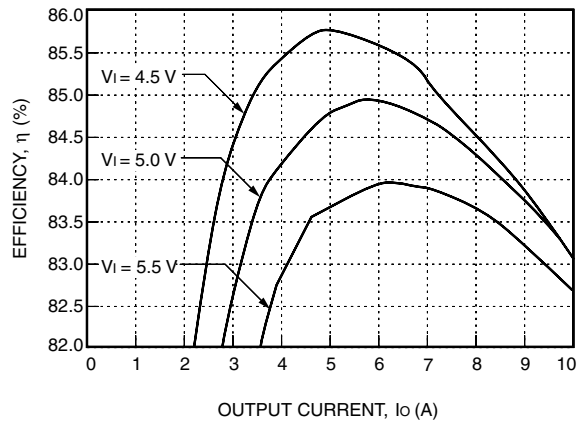

8-2431(C)

Figure 17. NH033M-L Efficiency, $T_A = 25\text{ }^\circ\text{C}$

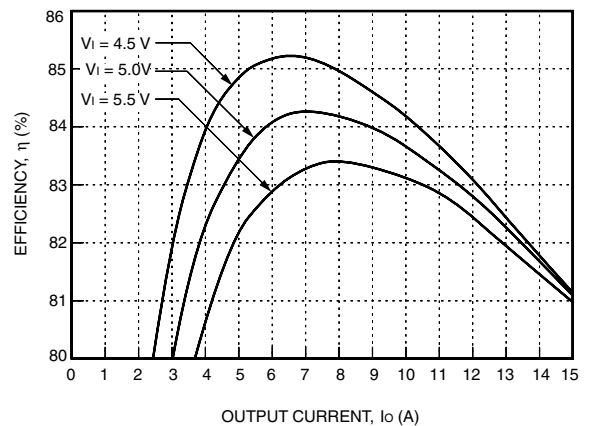

8-2435(C)

Figure 18. NH050M-L Efficiency, $T_A = 25\text{ }^\circ\text{C}$

Characteristics Curves (continued)

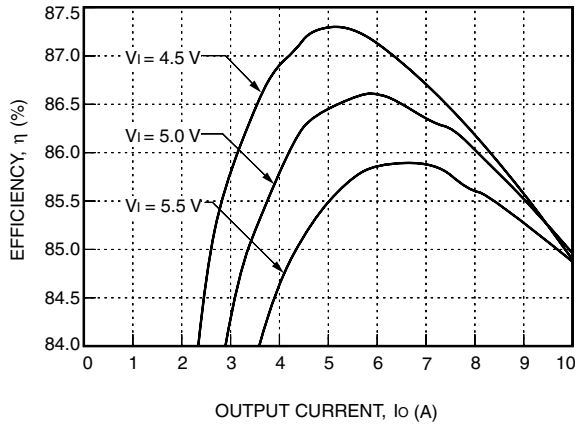

8-2432(C)

Figure 19. NH033S1R8-L Efficiency, $T_A = 25^\circ\text{C}$

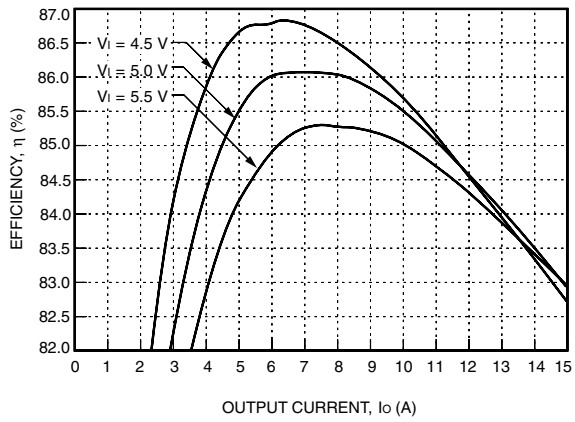

8-2436(C)

Figure 20. NH050S1R8-L Efficiency, $T_A = 25^\circ\text{C}$

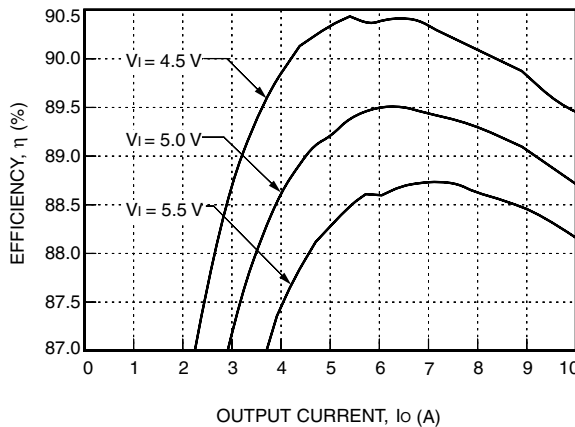

8-2430(C)

Figure 21. NH033G-L Efficiency, $T_A = 25^\circ\text{C}$

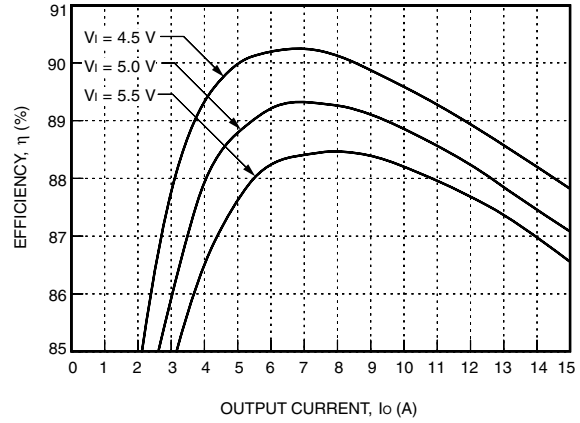

8-2434(C)

Figure 22. NH050G-L Efficiency, $T_A = 25^\circ\text{C}$

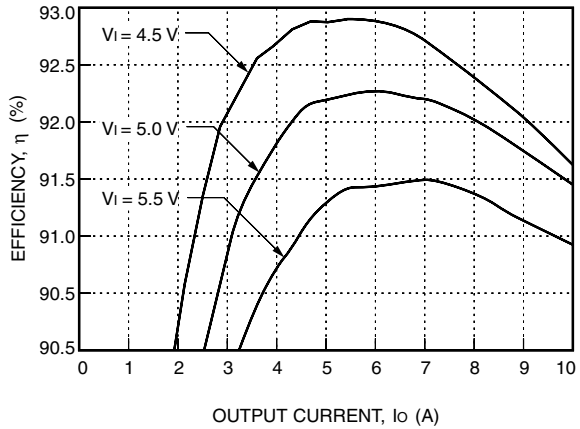

8-2429(C)

Figure 23. NH033F-L Efficiency, $T_A = 25^\circ\text{C}$

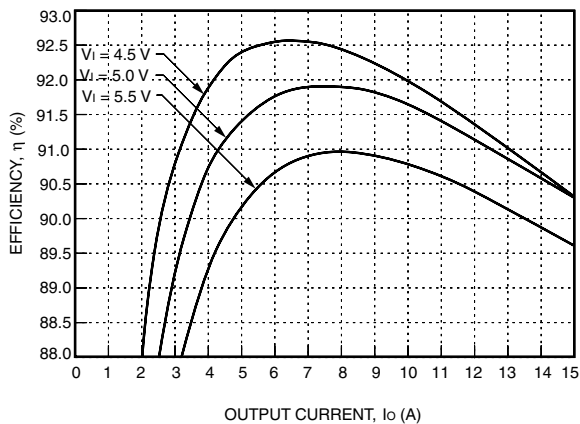

8-2433(C)

Figure 24. NH050F-L Efficiency, $T_A = 25^\circ\text{C}$

Characteristics Curves (continued)

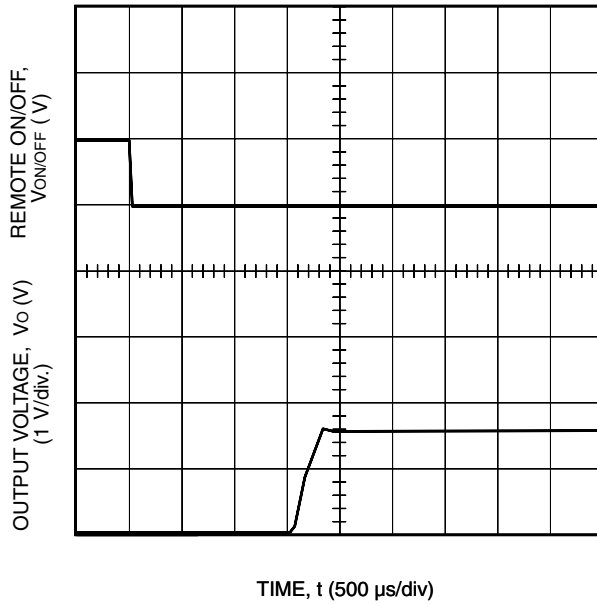

Figure 25. NH033M-L Typical Start-Up from Remote On/Off, V_i = 5 V, I_o = 10 A

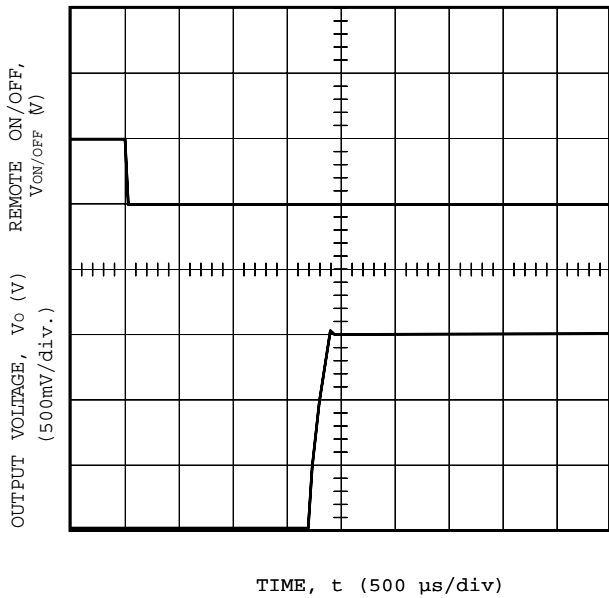

Figure 26. NH050M-L Typical Start-Up from Remote On/Off, V_i = 5 V, I_o = 15 A

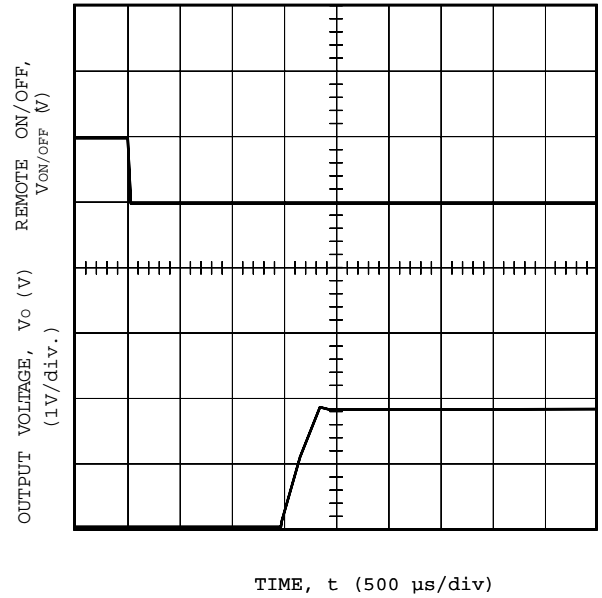

Figure 27. NH033S1R8-L Typical Start-Up from Remote On/Off, V_i = 5 V, I_o = 10 A

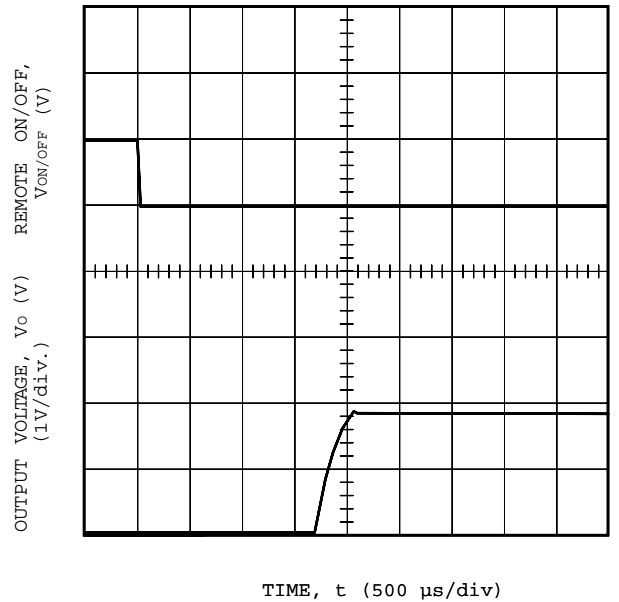
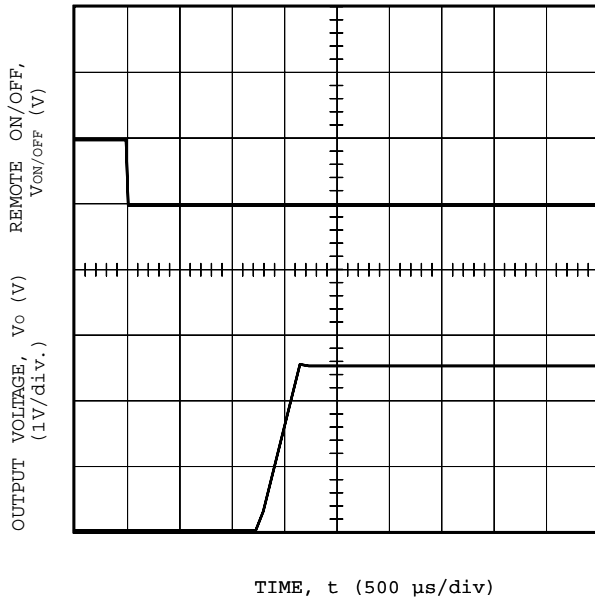

Figure 28. NH050S1R8-L Typical Start-Up from Remote On/Off, V_i = 5 V, I_o = 15 A

Characteristics Curves (continued)



8-2438(C)

Figure 29. NH033G-L Typical Start-Up from Remote On/Off, V_i = 5 V, I_o = 10 A

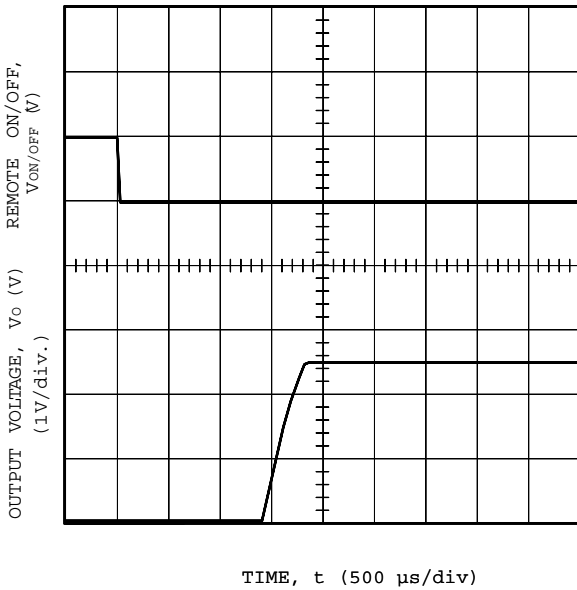

8-2443(C)

Figure 30. NH050G-L Typical Start-Up from Remote On/Off, V_i = 5 V, I_o = 15 A

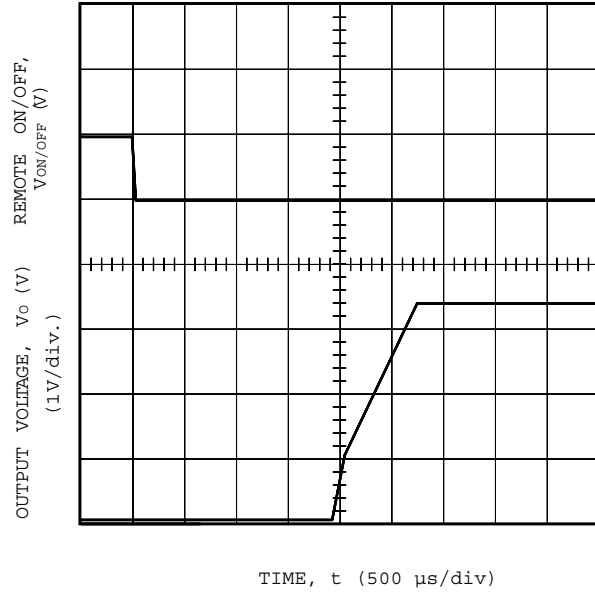

8-2437(C)

Figure 31. NH033F-L Typical Start-Up from Remote On/Off, V_i = 5 V, I_o = 10 A

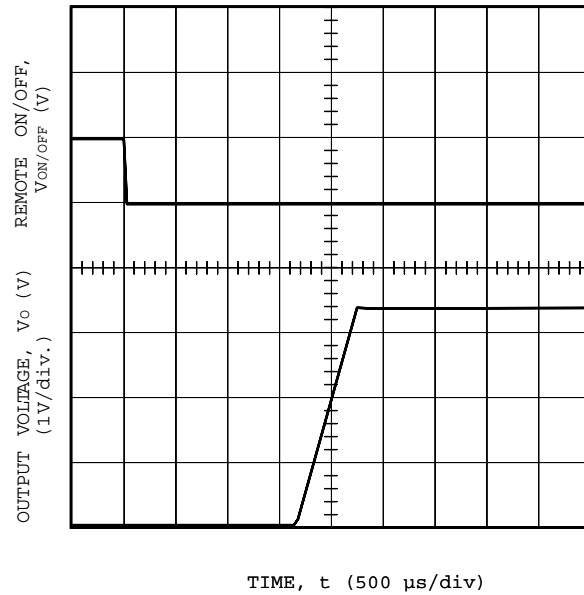

8-2441(C)

Figure 32. NH050F-L Typical Start-Up from Remote On/Off, V_i = 5 V, I_o = 15 A

Test Configurations

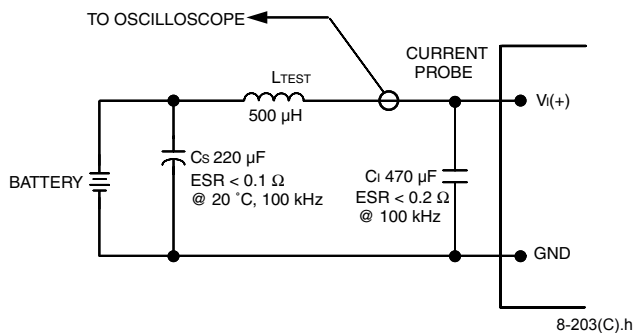

Note: Input reflected-ripple current is measured with a simulated source impedance of 500 nH. Capacitor C_s offsets possible battery impedance. Current is measured at the input of the module.

Figure 33. Input Reflected-Ripple Test Setup

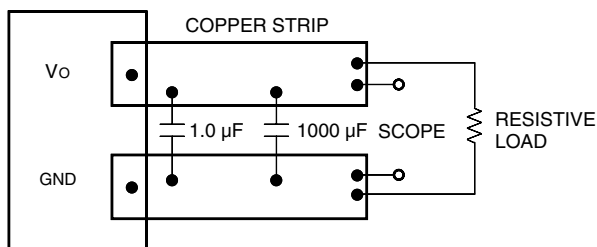

Note: Use a 0.1 µF ceramic capacitor and a 1,000 µF aluminum or tantalum capacitor (ESR = 0.05 % @ 100 kHz). Scope measurement should be made using a BNC socket. Position the load between 50 mm and 80 mm (2 in. and 3 in.) from the module.

Figure 34. Peak-to-Peak Output Noise Measurement Test Setup

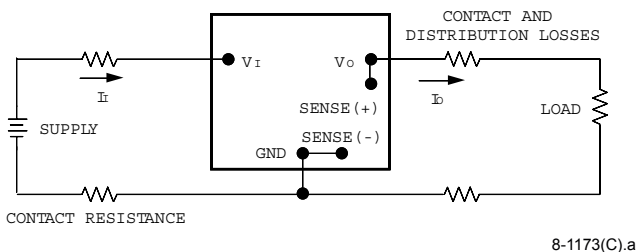

Note: All measurements are taken at the module terminals. When socketing, place Kelvin connections at module terminals to avoid measurement errors due to socket contact resistance.

$$\eta = \frac{V_o \times I_o}{V_i \times I_i} \times 100 \quad \%$$

Figure 35. Output Voltage and Efficiency Measurement Test Setup

Lineage Power

Design Considerations

Input Source Impedance

The power module should be connected to a low ac-impedance input source. Highly inductive source impedances can affect the stability of the NH033x-L and NH050x-L Series Power Modules. Adding external capacitance close to the input pins of the module can reduce the ac impedance and ensure system stability. The minimum recommended input capacitance (C_1) is a 470 µF electrolytic capacitor with an ESR $\leq 0.02 \Omega$ @ 100 kHz. Verify the quality and layout of these capacitors by ensuring that the ripple across the module input pins is less than 1 Vp-p at $I_o = I_{o, \max}$. (See Figures 33, 36, and 37.)

The 470 µF electrolytic capacitor (C_1) should be added across the input of the NH033x-L or NH050x-L to ensure stability of the unit. The electrolytic capacitor should be selected for ESR and RMS current ratings to ensure safe operation in the case of a fault condition. The input capacitor for the NH033x-L and NH050x-L series should be rated to handle 10 Arms.

When using a tantalum input capacitor, take care not to exceed the tantalum capacitor power rating because of the capacitor's failure mechanism (for example, a short circuit).

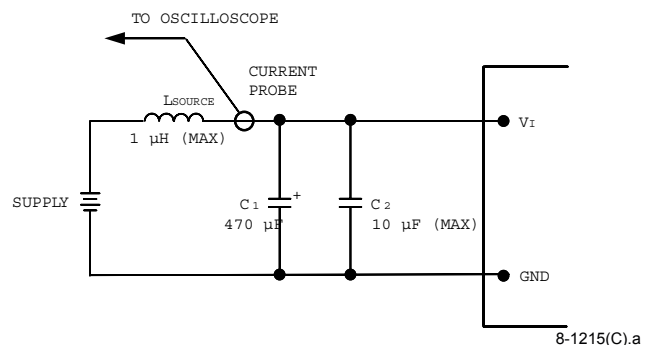

Figure 36. Setup with External Capacitor to Reduce Input Ripple Voltage

To reduce the amount of ripple current fed back to the input supply (input reflected-ripple current), an external input filter can be added. Up to 10 µF of ceramic capacitance (C_2) may be externally connected to the input of the NH033x-L or NH050x-L, provided the source inductance (L_{SOURCE}) is less than 1 µH (see Figure 36).

Design Considerations (continued)

Input Source Impedance (continued)

To further reduce the input reflected ripple current, a filter inductor (L_{FILTER}) can be connected between the supply and the external input capacitors (see Figure 37). The filter inductor should be rated to handle the maximum power module input current of 10 Adc for the NH033x-L and 16 Adc for the NH050x-L.

If the amount of input reflected-ripple current is unacceptable with an external L-C filter, more capacitance may be added across the input supply to form a C-L-C filter. For best results, the filter components should be mounted close to the power module.

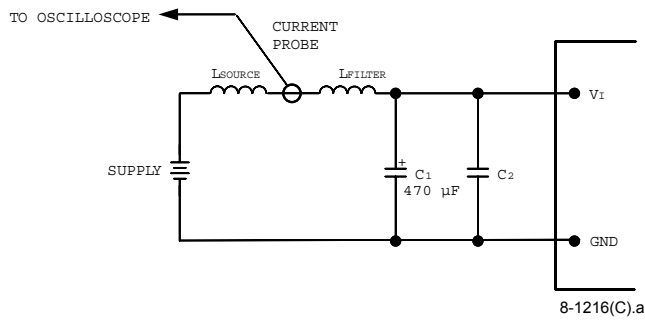

Figure 37. Setup with External Input Filter to Reduce Input Reflected-Ripple Current and Ensure Stability

Output Capacitance

The NH033x-L and NH050x-L Series Power Modules can be operated with large values of output capacitance. In order to maintain stability, choose a capacitor bank so that the product of their capacitance and ESR is greater than 50×10^{-6} (e.g., $1,000 \mu\text{F} \times 0.05 \Omega = 50 \times 10^{-6}$). For complex or very low ESR filters, consult the Technical Support for stability analysis.

Safety Considerations

For safety-agency approval of the system in which the power module is used, the power module must be installed in compliance with the spacing and separation requirements of the end-use safety agency standard, i.e., UL 60950, CSA C22.2 No. 60950-00, and VDE 0805 (IEC60950).

For the converter output to be considered meeting the requirements of safety extra-low voltage (SELV), the input must meet SELV requirements.

The power module has extra-low voltage (ELV) outputs when all inputs are ELV.

The input to these units is to be provided with a maximum 20 A normal-blow fuse in the ungrounded lead.

Feature Descriptions

Overcurrent Protection

To provide protection in a fault condition, the unit is equipped with internal overcurrent protection. The unit operates normally once the fault condition is removed.

Under some extreme overcurrent conditions, the unit may latch off. Once the fault is removed, the unit can be reset by toggling the remote on/off signal for one second or by cycling the input power.

Remote On/Off

To turn the power module on and off, the user must supply a switch to control the voltage at the ON/OFF pin ($V_{\text{on/off}}$). The switch should be an open collector pnp transistor connected between the ON/OFF pin and the V_1 pin or its equivalent (see Figure 38).

During a logic low when the ON/OFF pin is open, the power module is on and the maximum $V_{\text{on/off}}$ generated by the power module is 0.3 V. The maximum allowable leakage current of the switch when $V_{\text{on/off}} = 0.3 \text{ V}$ and $V_1 = 5.5 \text{ V}$ ($V_{\text{switch}} = 5.2 \text{ V}$) is 50 μA .

During a logic high, when $V_{\text{on/off}} = 2.8 \text{ V}$ to 5.5 V, the power module is off and the maximum $I_{\text{on/off}}$ is 10 mA. The switch should maintain a logic high while sourcing 10 mA.

Leave the remote ON/OFF pin open if not using that feature.

The module has internal capacitance to reduce noise at the ON/OFF pin. Additional capacitance is not generally needed and may degrade the start-up characteristics of the module.

Feature Descriptions (continued)

Remote On/Off (continued)

CAUTION: Never ground the ON/OFF pin. Grounding the ON/OFF pin disables an important safety feature and may damage the module or the customer system.

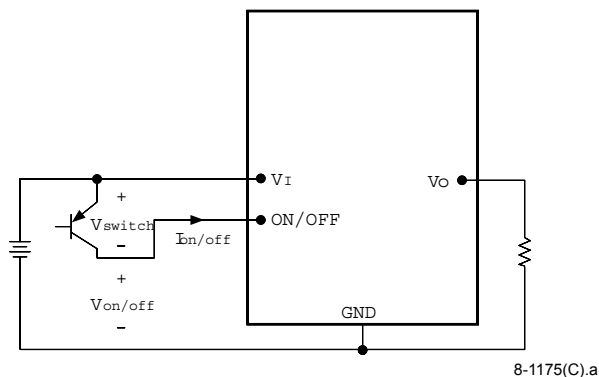

Figure 38. Remote On/Off Implementation

Remote Sense

Remote sense minimizes the effects of distribution losses by regulating the voltage at the remote-sense connections. The voltage between the remote-sense pins and the output pins must not exceed the output voltage sense range given in the Feature Specifications table.

The voltage between the Vo and GND pins must not exceed 110% of Vo, nom for Vo ≥ 2.5 V or 120% of Vo, nom for Vo < 2.5 V. This limit includes any increase in voltage due to remote-sense compensation and output voltage set-point adjustment (trim), see Figure 39.

If not using the remote-sense feature to regulate the output at the point of load, connect SENSE(+) to Vo and SENSE(-) to GND at the module.

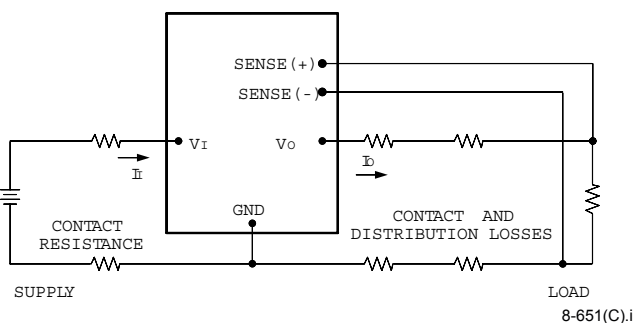

Figure 39. Effective Circuit Configuration for Single-Module Remote-Sense Operation

Lineage Power

Output Voltage Set-Point Adjustment (Trim)

Output voltage set-point adjustment allows the output voltage set point to be increased or decreased by connecting an external resistor between the TRIM pin and either the SENSE(+) pin (decrease output voltage) or SENSE(-) pin (increase output voltage). The trim range for modules that produce 2.5 Vo or greater is ±10% of Vo, nom. The trim range for modules that produce less than 2.5 Vo is +20%, -0%.

Connecting an external resistor (Rtrim-down) between the TRIM and SENSE(+) pin decreases the output voltage set point as defined in the following equation.

For the F (3.3 Vo) module:

$$R_{\text{trim-down}} = \left(\frac{18.23}{V_O - V_{O, \text{adj}}} - 47.2 \right) \text{k}\Omega$$

For the G (2.5 Vo) module:

$$R_{\text{trim-down}} = \left(\frac{6.98}{V_O - V_{O, \text{adj}}} - 24 \right) \text{k}\Omega$$

Note: Output voltages below 2.5 V cannot be trimmed down.

Connecting an external resistor (Rtrim-up) between the TRIM and SENSE(-) pins increases the output voltage set point to Vo, adj as defined in the following equation.

For the G (2.5 Vo) module:

$$R_{\text{trim-up}} = \left(\frac{28}{V_{O, \text{adj}} - V_O} - 10 \right) \text{k}\Omega$$

For all other modules:

$$R_{\text{trim-up}} = \left(\frac{28}{V_{O, \text{adj}} - V_O} - 33.2 \right) \text{k}\Omega$$

Leave the TRIM pin open if not using that feature.

Overvoltage Protection

Overvoltage protection is not provided in the power module. External circuitry is required to provide overvoltage protection.

Feature Descriptions (continued)

Overtemperature Protection

To provide additional protection in a fault condition, the unit is equipped with a nonlatched thermal shutdown circuit. The shutdown circuit engages when Q32 exceeds approximately 120 °C. The unit attempts to restart when Q32 cools down. The unit cycles on and off if the fault condition continues to exist. Recovery from shutdown is accomplished when the cause of the overheating condition is removed.

Thermal Considerations

The power modules operate in a variety of thermal environments; however, sufficient cooling should be provided to help ensure reliable operation of the unit. Heat is removed by conduction, convection, and radiation to the surrounding environment.

The thermal data presented is based on measurements taken in a wind tunnel. The test setup shown in Figure 40 was used to collect data for Figures 50 and 51. Note that the airflow is parallel to the long axis of the module. The derating data applies to airflow along either direction of the module's long axis.

The module runs cooler when it is rotated 90° from the direction shown in Figure 40. This thermally preferred orientation increases the maximum ambient temperatures 4 °C to 5 °C from the maximum values shown in Figures 50 and 51.

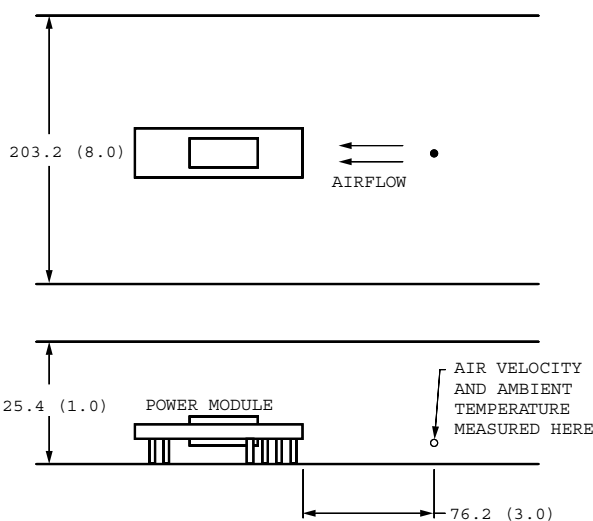

8-1199(C).a

Note: Dimensions are in millimeters and (inches).

Figure 40. Thermal Test Setup

Proper cooling can be verified by measuring the power module's temperature at lead 7 of Q32 as shown in Figure 41.

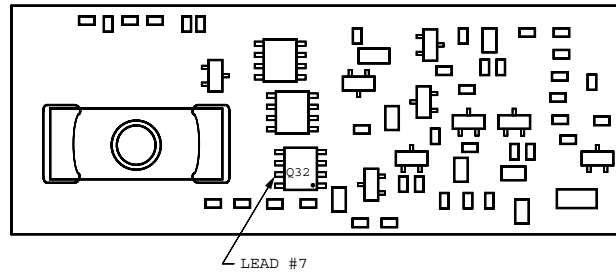

8-1149(C).b

Figure 41. Temperature Measurement Location

The temperature at this location should not exceed 115 °C at full power. The output power of the module should not exceed the rated power.

Convection Requirements for Cooling

To predict the approximate cooling needed for the module, determine the power dissipated as heat by the unit for the particular application. Figures 42 through 49 show typical power dissipation for the module over a range of output currents.

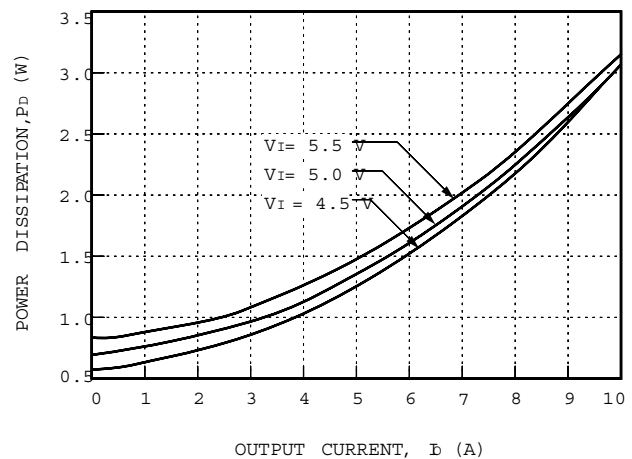

8-2446(C)

Figure 42. NH033M-L Typical Power Dissipation vs. Output Current, $T_a = 25\text{ °C}$

Thermal Considerations (continued)

Convection Requirements for Cooling
(continued)

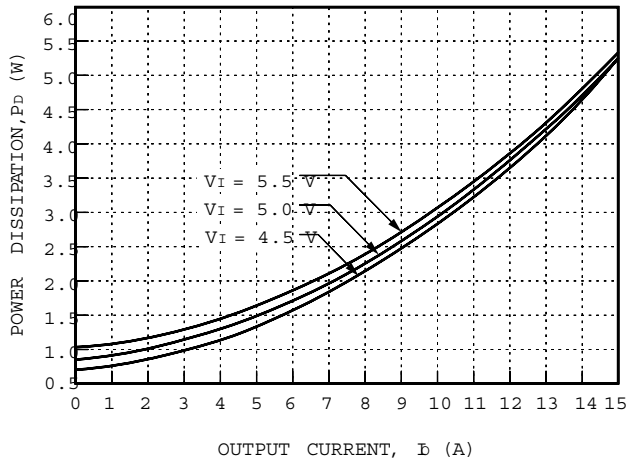

8-2450(C)

Figure 43. NH050M-L Typical Power Dissipation vs. Output Current, $T_A = 25^\circ\text{C}$

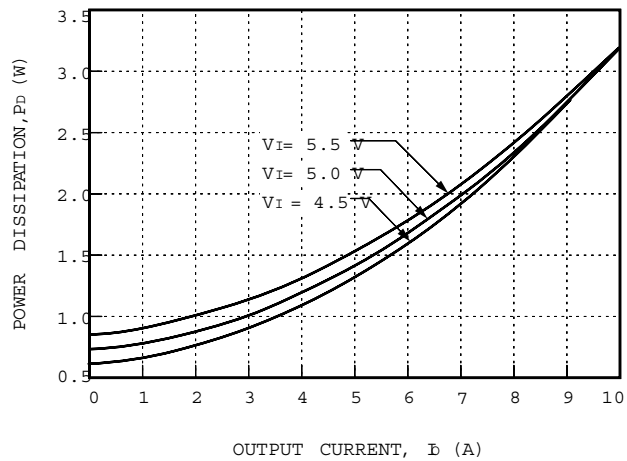

8-2447(C)

Figure 44. NH033S1R8-L Typical Power Dissipation vs. Output Current, $T_A = 25^\circ\text{C}$

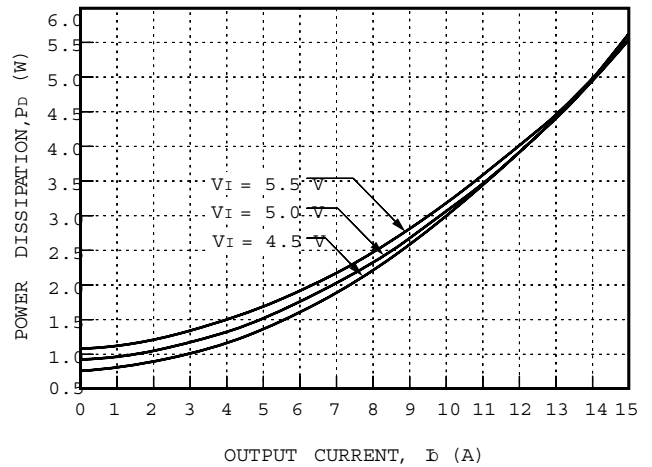

8-2451(C)

Figure 45. NH050S1R8-L Typical Power Dissipation vs. Output Current, $T_A = 25^\circ\text{C}$

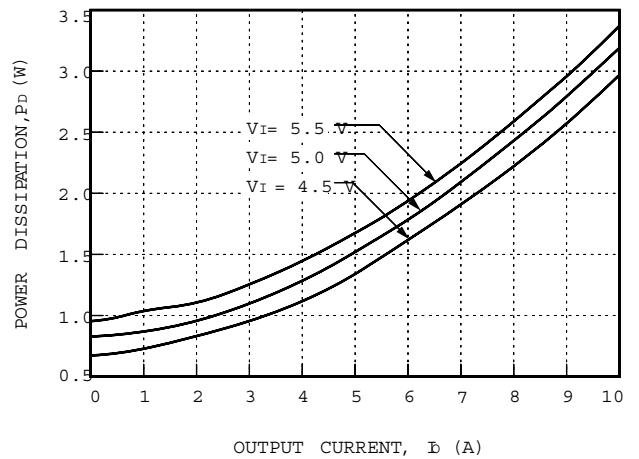

8-2445(C)

Figure 46. NH033G-L Typical Power Dissipation vs. Output Current, $T_A = 25^\circ\text{C}$

Thermal Considerations (continued)

Convection Requirements for Cooling
(continued)

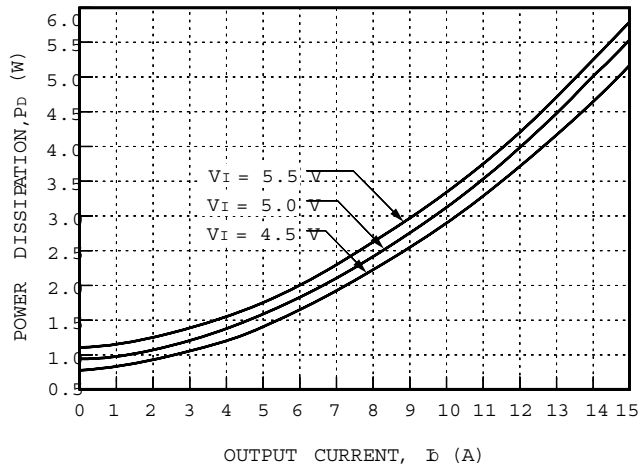

8-2449(C)

Figure 47. NH050G-L Typical Power Dissipation vs. Output Current, $T_A = 25\text{ }^\circ\text{C}$

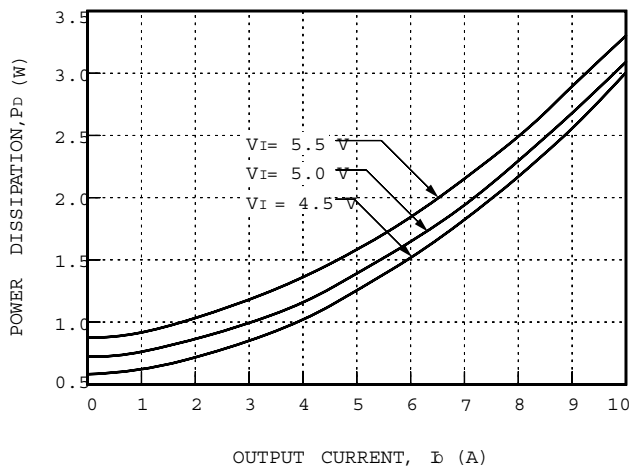

8-2444(C)

Figure 48. NH033F-L Typical Power Dissipation vs. Output Current, $T_A = 25\text{ }^\circ\text{C}$

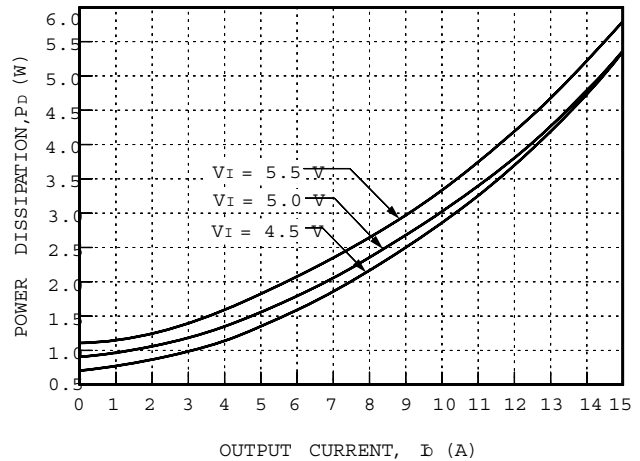

8-2448(C)

Figure 49. NH050F-L Typical Power Dissipation vs. Output Current, $T_A = 25\text{ }^\circ\text{C}$

With the known power dissipation and a given local ambient temperature, the minimum airflow can be chosen from the derating curves in Figures 50 and 51.

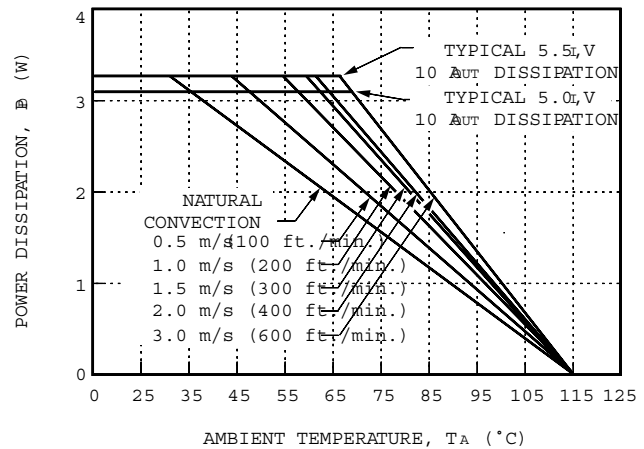

8-1425(C).c

Figure 50. NH033x-L Power Derating vs. Local Ambient Temperature and Air Velocity

Thermal Considerations (continued)

Convection Requirements for Cooling

(continued)

For example, if the NH050F-L dissipates 4 W of heat, the minimum airflow in a 65 °C environment is 1 m/s (200 ft./min.).

Keep in mind that these derating curves are approximations of the ambient temperatures and airflows required to keep the power module temperature below its maximum rating. Once the module is assembled in the actual system, the module's temperature should be checked as shown in Figure 41 to ensure it does not exceed 115 °C.

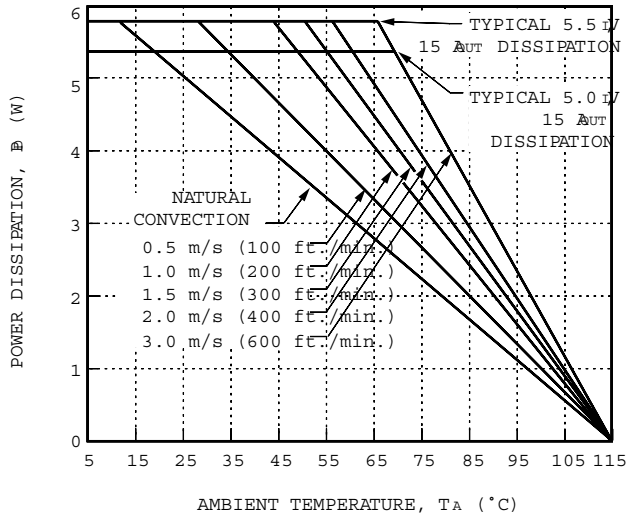

8-1426(C).b

Figure 51. NH050x-L Power Derating vs. Local Ambient Temperature and Air Velocity

Outline Diagram

Dimensions are in millimeters and (inches).

Tolerances: x.x mm ± 0.5 mm (x.xx in. ± 0.02 in.), x.xx mm ± 0.25 mm (x.xxx in. ± 0.010 in.).

Top View

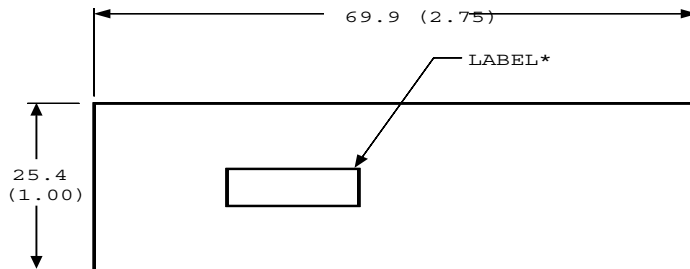

Side View

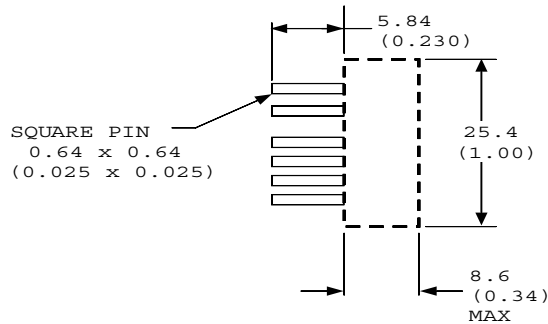

Bottom View

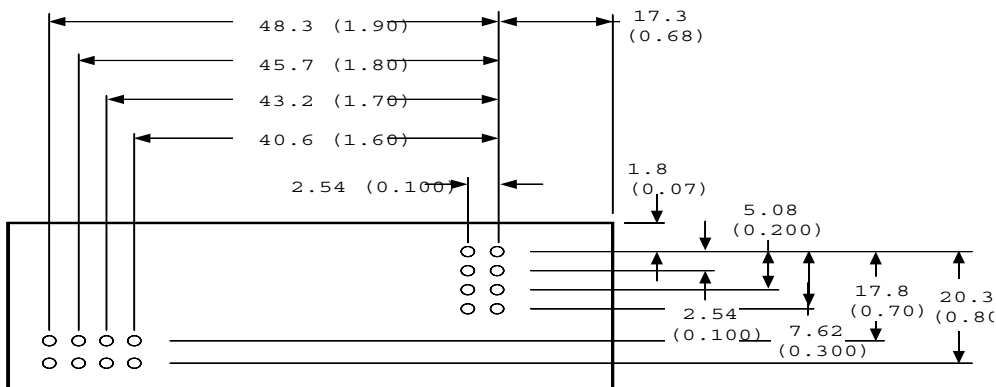

* Label includes product designation and date code.

Recommended Hole Pattern

Dimensions are in millimeters and (inches).

Tolerances: x.xx mm ± 0.13 mm (x.xxx in. ± 0.005 in.).

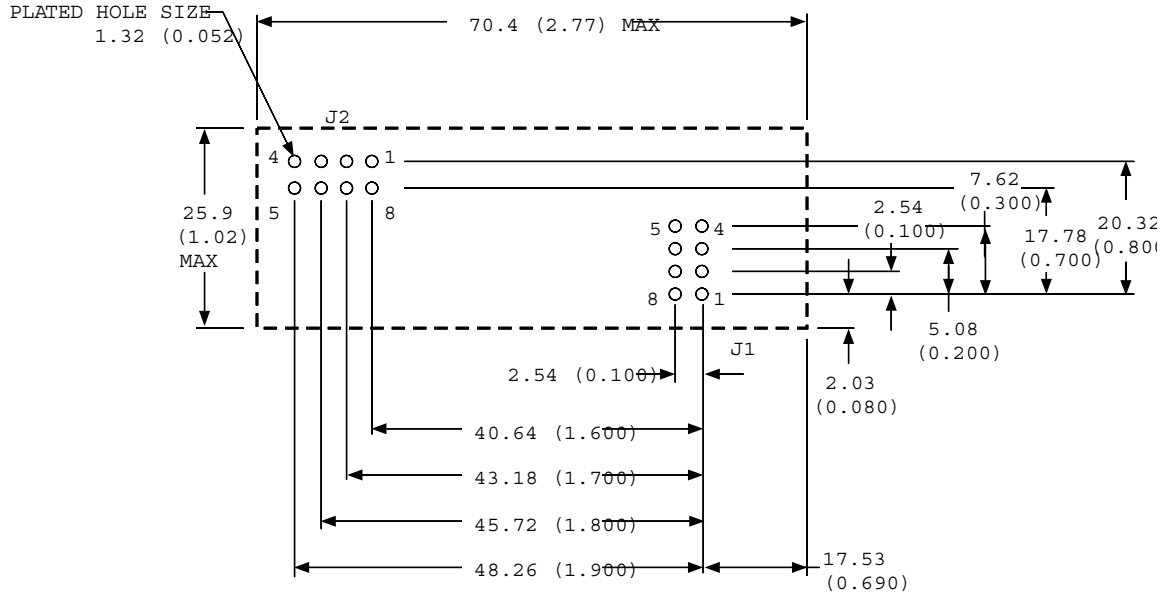

8-1176(C),b

Pin	Function	Pin	Function
J1 - 1	Remote On/Off	J2 - 1	SENSE (-)
J1 - 2	No Connection	J2 - 2	SENSE (+)
J1 - 3	TRIM	J2 - 3	V _o
J1 - 4	GND	J2 - 4	V _o
J1 - 5	GND	J2 - 5	V _o
J1 - 6	V _i	J2 - 6	V _o
J1 - 7	V _i	J2 - 7	GND
J1 - 8	V _i	J2 - 8	GND

Ordering Information

Please contact your Lineage Power Account Manager or Field Application Engineer for pricing and availability.

Table 3. Device Codes

Input Voltage	Output Voltage	Output Power	Device Code	Comcode
5 V	1.5 V	15 W	NH033M-L	107993685
5 V	1.8 V	18 W	NH033S1R8-L	107940306
5 V	2.5 V	25 W	NH033G-L	107917122
5 V	3.3 V	33 W	NH033F-L	107859928
5 V	1.5 V	22.5 W	NH050M-L	107993693
5 V	1.8 V	27 W	NH050S1R8-L	107940314
5 V	2.5 V	37.5 W	NH050G-L	107917130
5 V	3.3 V	50 W	NH050F-L	107917148

Table 4. Device Options

Option	Suffix
Tight tolerance output	2
Short pins: 2.79 mm ± 0.25 mm (0.110 in. ± 0.010 in.)	8



LINEAGE POWER

World Wide Headquarters
Lineage Power Corporation
3000 Skyline Drive, Mesquite, TX 75149, USA
+1-800-526-7819
(Outside U.S.A.: **+1-972-284-2626**)
www.lineagepower.com
e-mail: techsupport1@lineagepower.com

Asia-Pacific Headquarters
Tel: +65 6416 4283

Europe, Middle-East and Africa Headquarters
Tel: +49 89 6089 286

India Headquarters
Tel: +91 80 28411633

Lineage Power reserves the right to make changes to the product(s) or information contained herein without notice. No liability is assumed as a result of their use or application. No rights under any patent accompany the sale of any such product(s) or information.

© 2008 Lineage Power Corporation, (Mesquite, Texas) All International Rights Reserved.