

Interface RF Connector with Switch

MS-151C Series

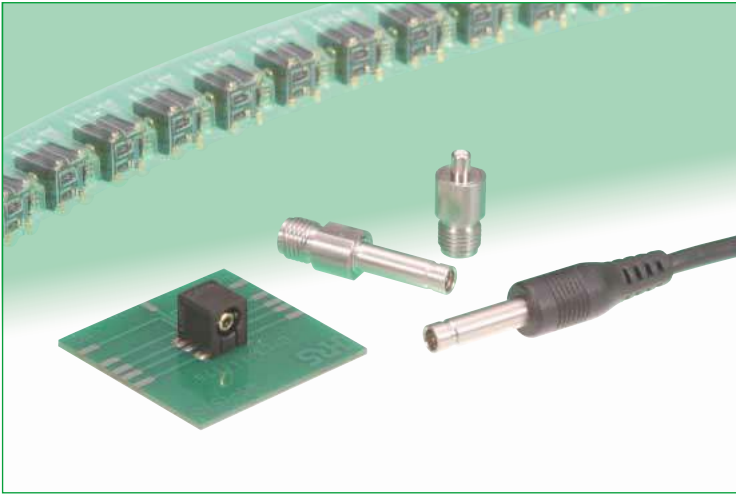

Overview

Designed for end user applications requiring re-direction of the transmission.

Small size, lightweight and high reliability make it ideal for use in wireless applications requiring bandwidth of up to 6GHz.

Features

1. Confirmation of complete connection

Built-in interlock feature confirms fully mated condition with a "click" sensation.

2. Non-directional connection

The connector can be mated in any position on a 360° axis and can rotate within the same when in use, allowing routing of the connected cable in any direction.

3. High durability

Guaranteed 5000 insertion/removal cycles.

4. Space-saving

The external dimensions of the board-mounted receptacle (7.3mm high, 7.9mm wide and 8.45mm deep) make it ideal for use in small devices.

5. Ease of connection and handling

Over-molded plug, with convenient grip and built-in cable strain relief assures reliable mating/un-mating by the end user.

6. Designed for board placement with automatic equipment

Top surface of receptacle assembly is flat, allowing reliable hold for vacuum nozzles of automatic placement equipment.

7. RoHS compliant

All components and materials comply with EU Directive 2002/95/EC, with respect to all applicable substances.

Applications

GPS terminals, wireless LAN modules, desktop and notebook computers, PDA's, high frequency equipment and other applications requiring re-direction of the transmission.

Plug can be rotated after full insertion.

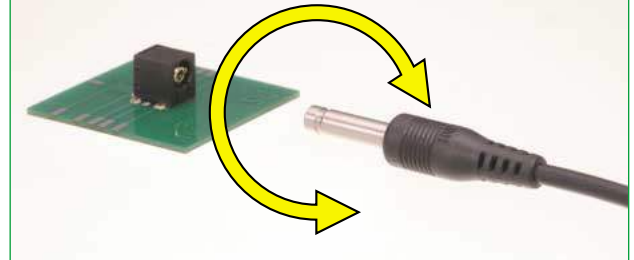

●Receptacle

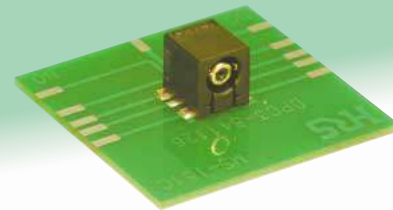

MS-151C

●Plug



MS-151-C(BP)

●SMA Conversion Adapter For Receptacle: MS-151C



MS151P-HRMJ-1

●SMA Conversion Adapter For Plug: MS-151-C(BP)



MS151J-HRMJ

Product Specifications

Frequency range	DC to 6GHz		
Operating temperature range	-40°C to +85°C		
Power rating	4W		
		Not mated with the plug	Open (Mated with MS-151-C(BP))
V.S.W.R.	DC to 2 GHz	1.2 max.	1.3 max.
	2 GHz to 4 GHz	1.3 max.	1.5 max.
	4 GHz to 5 GHz		1.7 max.
	5 GHz to 6 GHz	1.7 max.	
Insertion loss	DC to 2 GHz	0.4dB max.	0.4dB max.
	2 GHz to 4 GHz	0.5dB max.	0.6dB max.
	4 GHz to 5 GHz		0.8dB max.
	5 GHz to 6 GHz	1.0dB max.	
Isolation loss	DC to 2 GHz	————	18dB min.
	2 GHz to 4 GHz	————	14dB min.
	4 GHz to 6 GHz	————	12dB min.

Item	Specification	Conditions
1. Contact resistance	50 mΩ max.	100 mA
2. Insulation resistance	1000 MΩ min.	100 V DC
3. Withstanding voltage	No flashover or insulation breakdown	100 V AC / 1 minute
4. Vibration	No electrical discontinuity of 10 μs or more	Frequency : 10 to 500 Hz, single amplitude of 0.75 mm, 2 hours in each of the 3 directions
5. Shock	No electrical discontinuity of 10 μs or more	Acceleration of 490 m/s ² , 6 ms duration, sine half-wave waveform, 3 cycles in each of the 3 axis
6. Temperature cycle	Contact resistance: 100 mΩ max. Insulation resistance: 10 MΩ min.	Temperature : -55°C → +5°C to +35°C → +85°C → +5°C to +35°C Time : 30 → 5 → 30 → 5 (Minutes) 100 cycles
7. Humidity (Steady state)	Contact resistance: 100 mΩ max. Insulation resistance: 10 MΩ min.	96 hours at 40°C, humidity of 90% to 95%
8. Salt spray	Contact resistance: 100 mΩ max. No excessive corrosions	5% salt water solution, 48 hours
9. Mating/un-mating forces	Mating : 1 to 10N Un-mating : 3 to 15N	With corresponding connector (Initial value)
10. Durability (insertion/ withdrawal)	Contact resistance: 100 mΩ max.	5000 cycles

Materials

Receptacle

Part	Material	Finish
Insulator	Polyamide (UL94V-0)	————
Lock mating section	Stainless steel	Gold plated
Outer conductor	Phosphor bronze	Gold plated
Contact A	Phosphor bronze	Gold plated
Contact C	Beryllium copper	Gold plated

Plug

Part	Material	Finish
Ring	Stainless steel	Nickel plated
Outer conductor	Phosphor bronze	Nickel plated
Inner contact	Phosphor bronze	Gold plated
Insulator	PTFE	————
Ferrule	Phosphor bronze	————
Bushing	TPEE-M	————

◆ High Frequency Characteristics (Typical)

● NORMALLY CLOSED(N.C) ~ (Not mated with the plug)

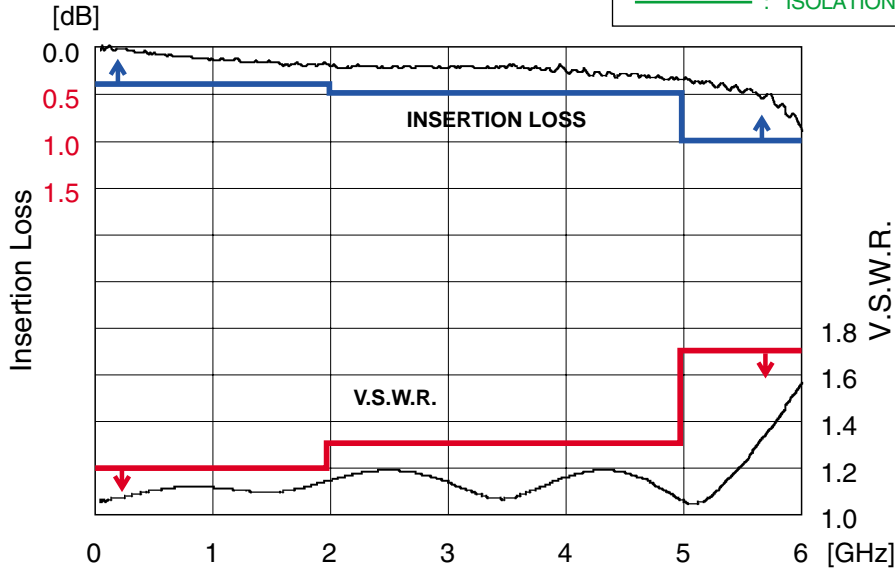
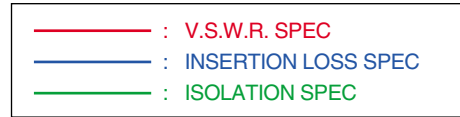

● OPEN(N.O) ~ (Mated with the plug)

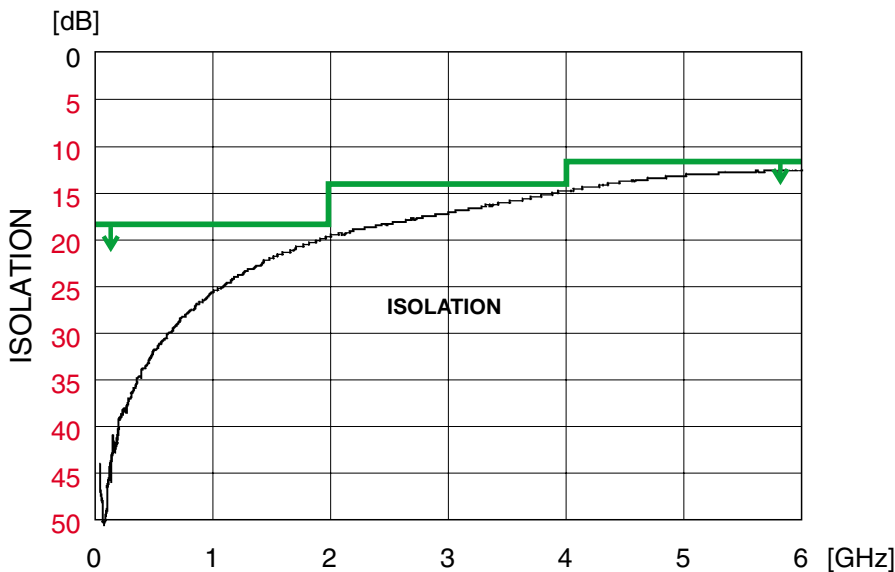
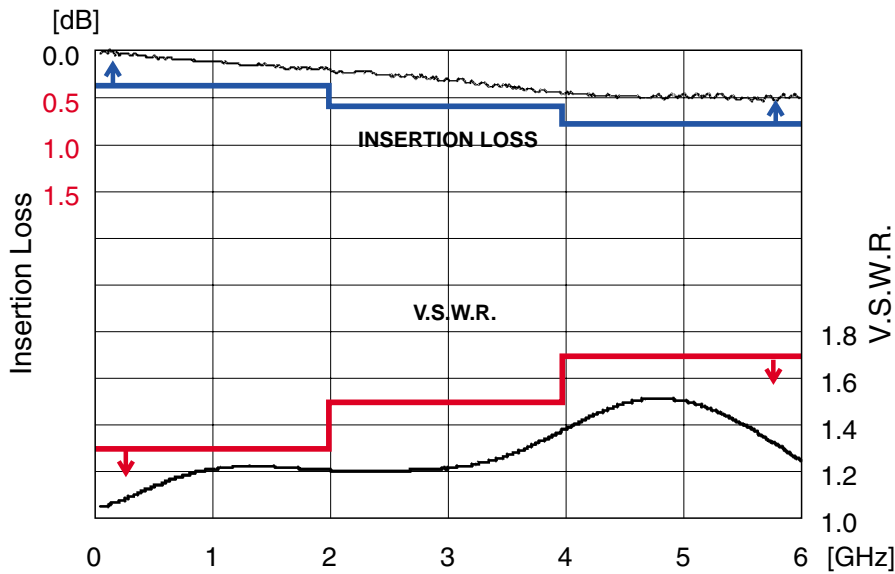

■ Receptacle

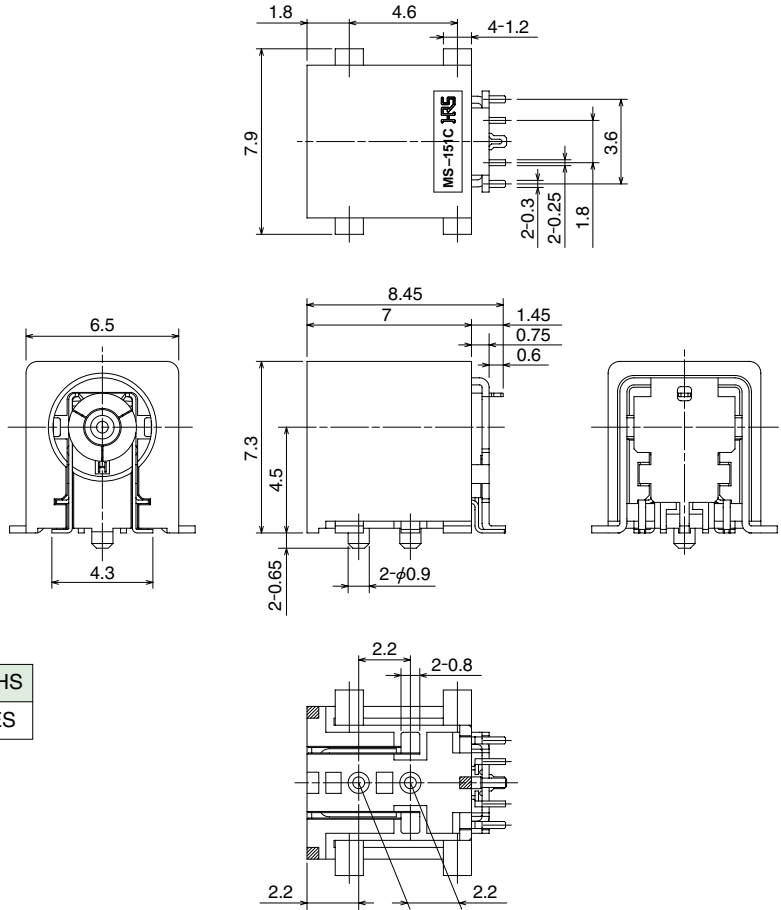
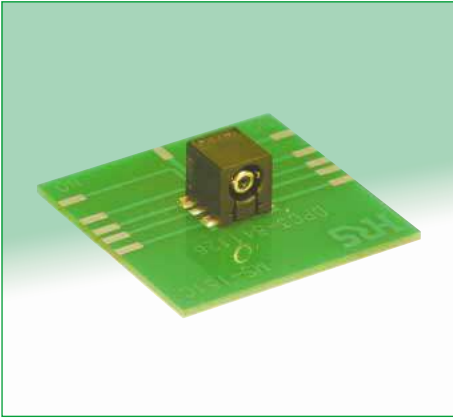

Part Number	CL No.	Packaging	RoHS
MS-151C	358-0211-8	800 pieces per reel	YES

◆ Circuit diagram

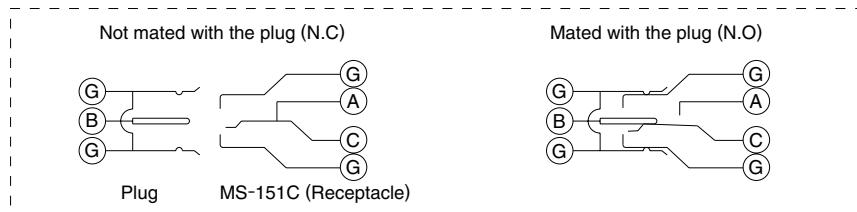

◆ PCB mounting pattern

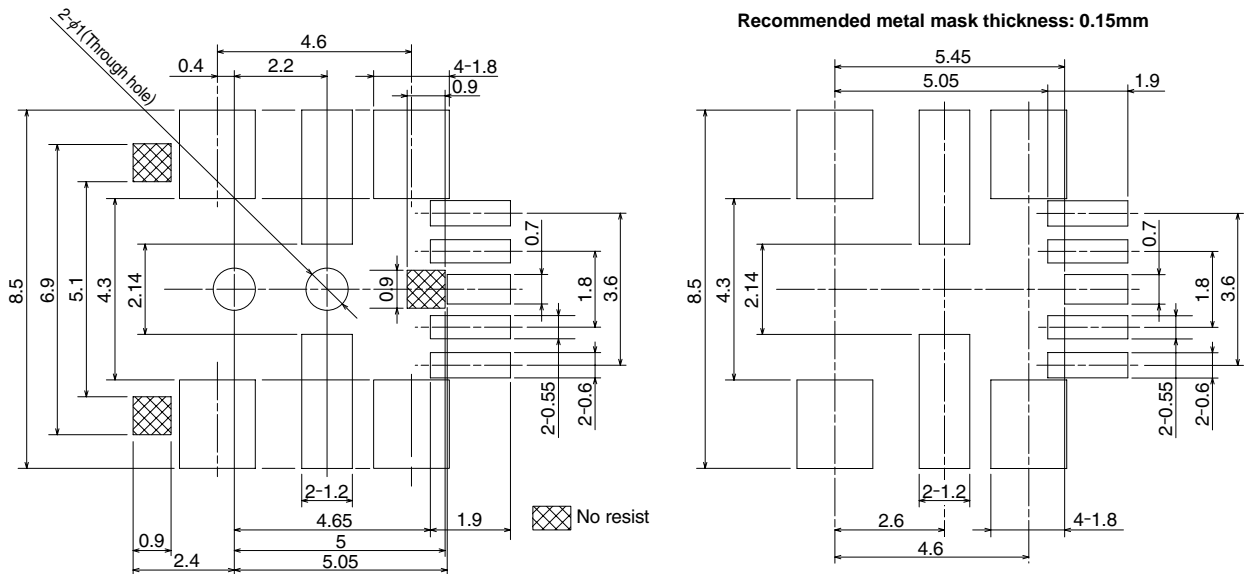

◆ Packaging Specifications

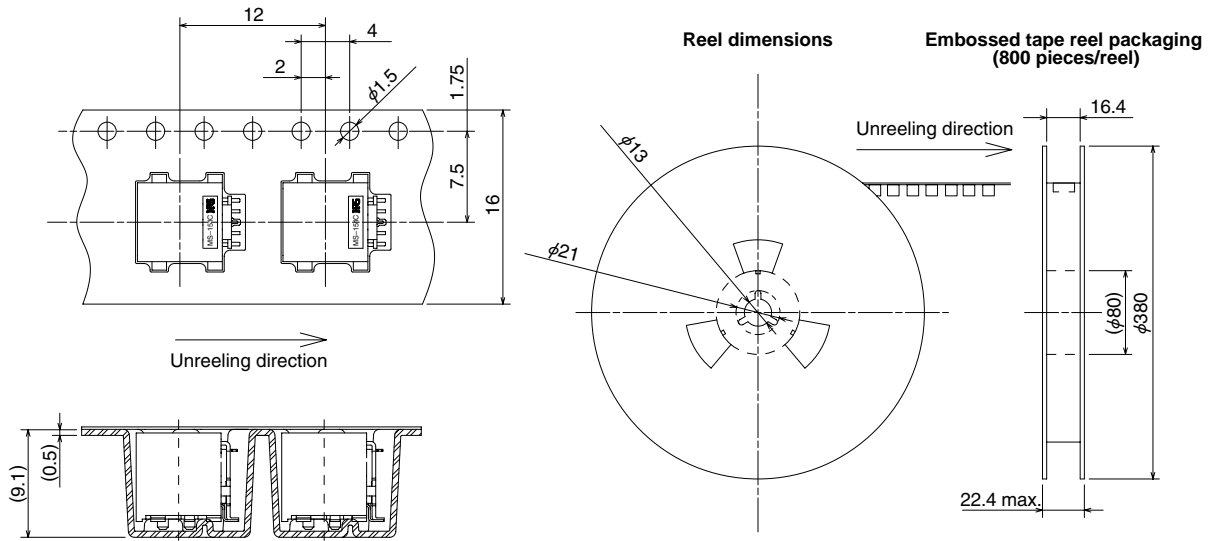

◆ Recommended Temperature Profile

Lead-free Solder Paste

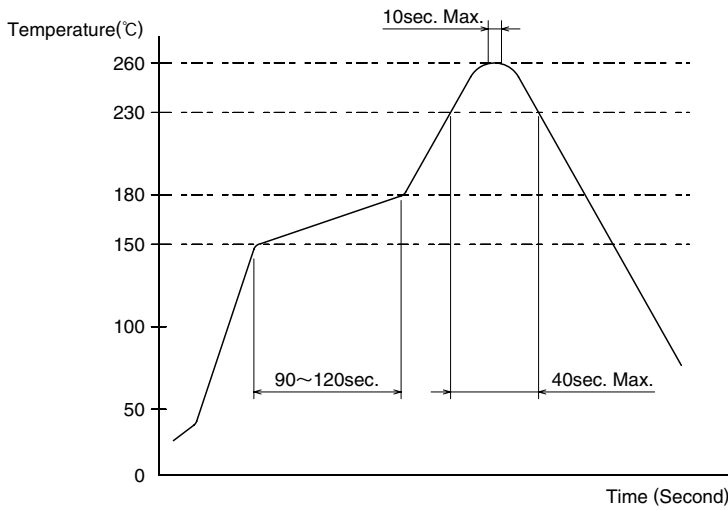

Maximum temperature	: 260°C
Duration of peak temperature	: 10 sec. max.
Peak temperature	: 240°C to 255°C
230°C min	: 40 sec. max.
150°C to 180°C	: 90 to 120 sec.

■ Plug

* Supplied by HRS only as a terminated cable assembly.

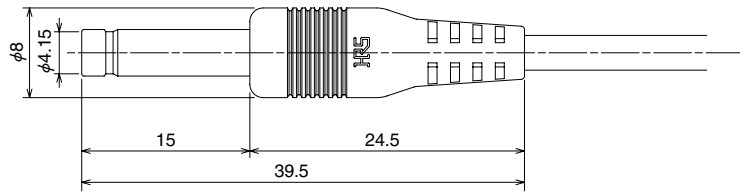

Part Number	CL No.	Applicable cable	Packaging	RoHS
MS-151-C(BP)	358-0219-0	1.5DS-QEHV(TA)	1	YES

■ SMA Conversion adapters

● For Receptacle: MS-151C

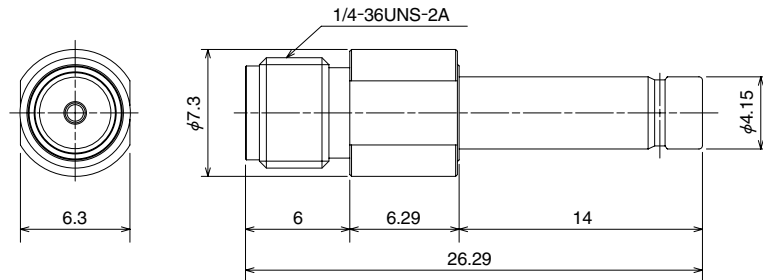

Part Number	CL No.	Packaging	RoHS
MS151P-HRMJ-1	355-0090-6	1	YES

● For Plug: MS-151-C(BP)

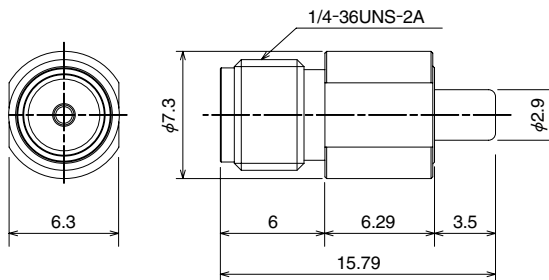

Part Number	CL No.	Packaging	RoHS
MS151J-HRMJ	355-0088-4	1	YES

■ Applications

● Wireless LAN IEEE802.11a/b/g

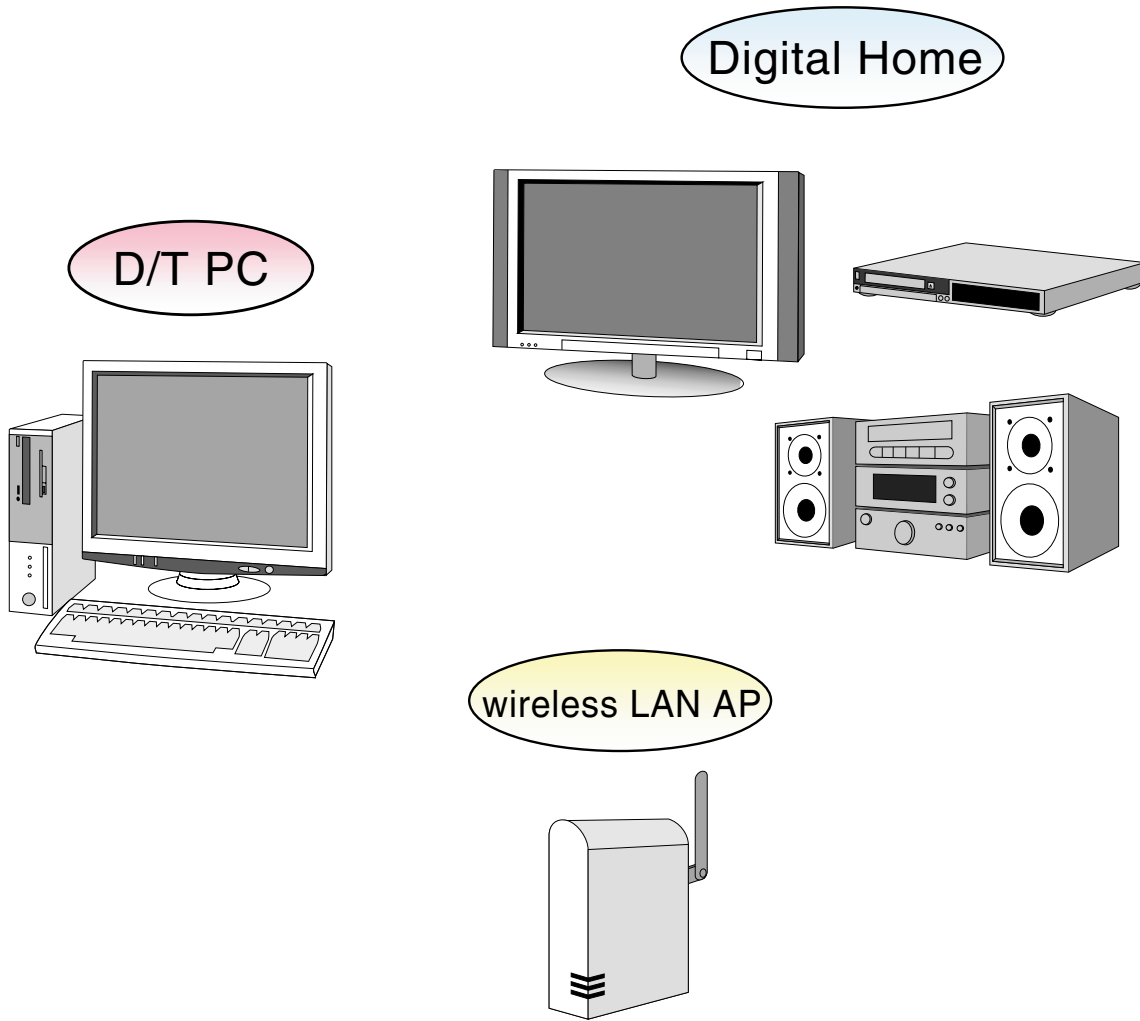

◆ Desktop PC with inner antenna for wireless LAN

