



150HBRW4_3 Series

150W Half-Brick - Single Output DC-DC Converter - Wide Input - Isolated & Regulated

DC-DC Converter

150 Watt

- ⊕ Wide input voltage range: 50-160V
- ⊕ High efficiency up to 91%
- ⊕ 3000VDC isolation
- ⊕ Short circuit protection (SCP)
- ⊕ Operating temperature range: -40°C~+100°C
- ⊕ International standard: 1/2 brick
- ⊕ Meets requirements of railway standard EN50155
- ⊕ Input under-voltage, output over-voltage, over-current, over-temperature protection

The 150HBRW4_1.5 series is a high performance product designed for the field of railway applications. Output power up to 150W, no min load requirement, wide input voltage 50-160VDC, which allows the base plate operating temperature up to 100°C. Further product features include input under-voltage protection, output over-voltage protection, short circuit protection, over current protection, over temperature protection, remote control and compensated, output voltage regulation functions. Meets the EN50155 railway standard. Widely used in the railway system and associated equipment.



Common specifications

Short circuit protection:	Continuous, automatic recovery
Operation temperature range:	-40°C~+100°C
Storage temperature range:	-55°C ~+125°C
Over temperature protection:	Base-plate temperature 100°C MIN, 120°C MAX
Pin welding temperature:	1.5mm from casing, 10 sec, 300°C MAX
Storage humidity range:	< 95%
Temperature coefficient:	±0.03%/°C (full load)
Cooling:	Natural convection or forced convection
Thermal resistance (without/with heatsink):	Natural convection: 7.8/3.7°C/W 200LFM convection: 4.44/2.2°C/W 400LFM convection: 3.39/1.76°C/W 1000LFM convection: 2.52/1.28°C/W
Case material:	Epoxy, aluminium base plate
MTBF:	MIL-HDBK-217F2, 500 Khours
Cooling Test:	EN60068-2-1
Dry heat:	EN60068-2-2
Damp heat:	EN60068-2-30
Shock and vibration test:	IEC/EN61373
Weight:	70g, 120g with heatsink

Input specifications

Item	Test condition	Min	Typ	Max	Units
Input current	Nominal input, full load/no load		1495/3	1532/10	mA
Reflected ripple current	Nominal input		80		mA
Input impulse voltage	1sec. max.	-0.7		180	VDC
Starting voltage			47	50	VDC
Under-voltage shutdown voltage		35	43	50	VDC
Start time			25		ms
Input filter	Pi filter				
Hot plug	Unavailable				
Ctrl*	<ul style="list-style-type: none"> • Module switch on • Module switch off • Input current when switched off 			Ctrl suspended or connected to TTL high level (3.5-12VDC) Ctrl connected to -Vin or low level (0-1.2VDC)	2 5 mA

* The voltage of Ctrl pin is relative to input pin -Vin.

Output specifications

Item	Test condition	Min	Typ	Max	Units
Output voltage accuracy	Nominal input, 10%-100% load		±1	±3	%
Line regulation	Full load, input voltage from low to high			±0.3	%
Load regulation	Nominal input, 10%-100% load			±0.5	%
Over current protection	$V_{imin} \leq V_i \leq V_{imax}$		120		%
Transient response deviation	<ul style="list-style-type: none"> • 15V/24V output • 12V output 		±3 ±4	±5 ±8	%Vo %Vo
Transient recovery Time	25% load step change		300	500	µs
Ripple & Noise*	20MHz Bandwidth (with 10%-100% load)		60	150	mVp-p
Output voltage regulated range	Trim		95	110	%Vo
Output voltage remote compensation	Sense			105	%Vo
Switching frequency	PWM mode		160		KHz
Over voltage protection	Input voltage range	110		140	%Vo
Over current protection	Input voltage range	110	130	180	%Io

* See ripple and noise section, page 4.

Isolation specifications

Item	Test condition	Min	Typ	Max	Units
Isolation voltage	<ul style="list-style-type: none"> • input-output • input-aluminium plate • output-aluminium plate 	3000 1500 1000			VDC
Isolation resistance	Input-output		500		MΩ
Isolation capacitance	Input-output, 100KHz/0.1V		2500		pF

Example:

150HBRW4_11012S3

W= 150 Watt; HBR= Half Brick; W4= Wide input (4:1);
110= 50-160Vin; 12= 12Vout; S= Single Output; 3= 3kVDC Isolation

150HBRW4_3 Series

150W Half-Brick - Single Output DC-DC Converter - Wide Input - Isolated & Regulated

EMC specifications				
EMI	CE	CISPR22/EN55022	CLASS B	(see EMC solution recommended circuit)
EMS	ESD	IEC/EN61000-4-2 GB/T17626.2	Contact ±6KV; Air ±8KV	perf. Criteria B
EMS	RS	IEC/EN61000-4-3 GB/T17626.3	10V/m	perf. Criteria A
EMS	CS	IEC/EN61000-4-6 GB/T17626.6	10Vr.m.s	perf. Criteria A
EMS	EFT	IEC/EN61000-4-4 GB/T17626.4	±2KV (5KHz, 100KHz)	(see EMC solution-module recommended circuit) perf. Criteria B
EMS	Surge	IEC/EN61000-4-5 GB/T17626.5	±2KV (1.2µs/50µs 2Ω)	(see EMC solution-module recommended circuit) perf. Criteria B
EMS	Immunities of short interruption	EN50155	100%-0%, 10ms	(see EMC solution-module recommended circuit) perf. Criteria B

Part Number	Input Voltage [VDC]			Output Voltage [VDC]	Output Current [mA, max]	Capacitive load [µF]	Efficiency [%, typ]
	Nominal	Range	Max*				
150HBRW4_11012S3	110	66-160/50-66	170	12	12500/10000	10000	89
150HBRW4_11015S3	110	66-160/50-66	170	15	10000/8000	6800	89
150HBRW4_11024S3	110	66-160/50-66	170	24	6250/5000	4400	91

Add suffix H for heatsink, f.ex. 150HBRW4_11012S3H

* Absolute maximum rating without damage on the converter, but it isn't recommended.

Efficiency

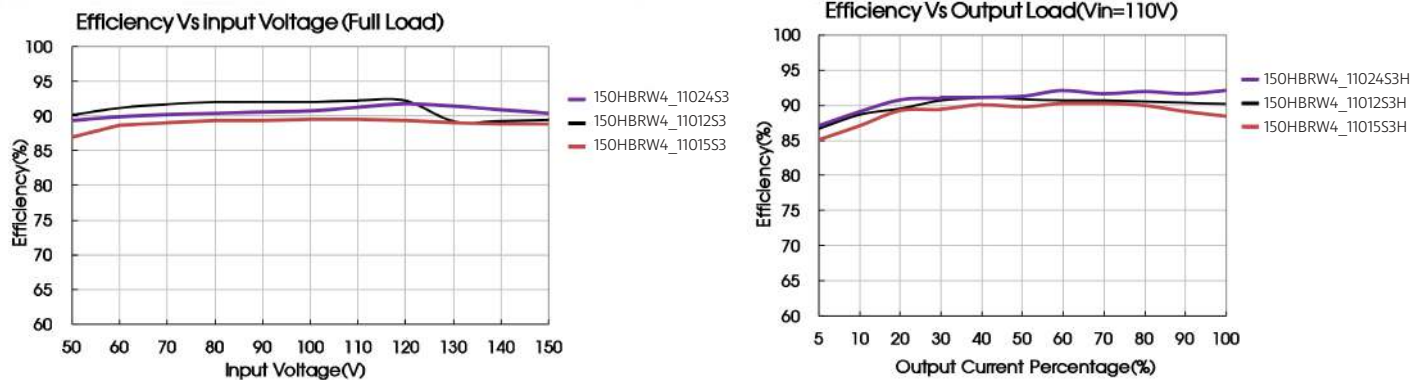

150HBRW4_3 Series

150W Half-Brick - Single Output DC-DC Converter - Wide Input - Isolated & Regulated

Temperature derating curve

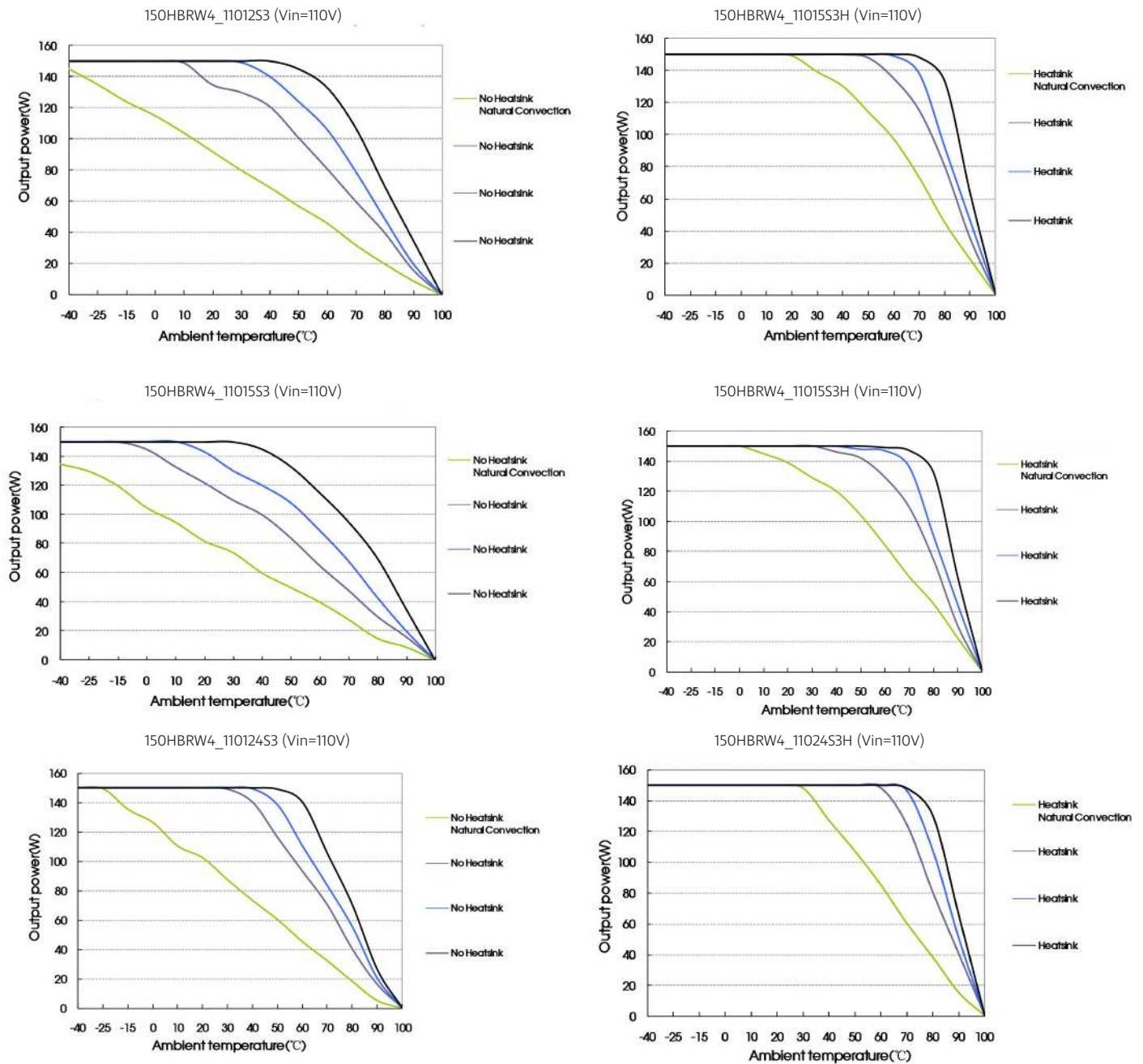

150HBRW4_3 Series

150W Half-Brick - Single Output DC-DC Converter - Wide Input - Isolated & Regulated

Sense of application and precautions

When remote sense is not used

1. When remote sense is not used, make sure +Vo and Sense + are shorted, and that 0V and Sense- are shorted as well;
2. Keep the patterns between +Vo and Sense + and 0V and Sense- as short as possible. Avoid a looping pattern. If noise enters the loop, the operation of the power module will become unstable.

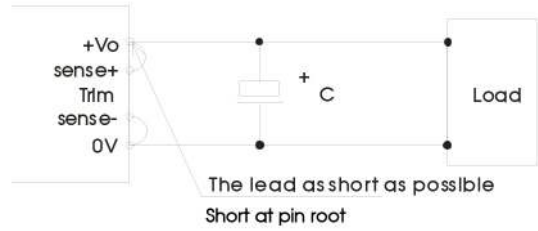

When remote sense is used

1. Using remote sense with long wires may cause output voltage to become unstable. Consult us if long sensing wiring is necessary.
2. Sense patterns or wires should be as short as possible. If wires are used, use either twisted-pair or shielded wires.
3. Please Use wide PCB trace or a thick wires between the power supply module and the load, the line voltage drop should be kept less than 0.3V. Make sure the power supply module's output voltage remains within the specified range.
4. The impedance of wires may cause the output the voltage oscillation or have a greater ripple, please do adequate assessments before using.

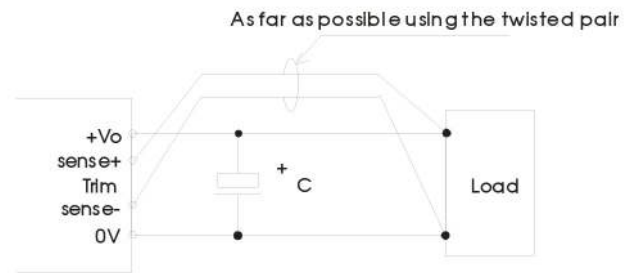

Ripple and noise

When remote sense is not used

All the 150HBRW4_3 series have been tested according to the following recommended test circuit before leaving the factory (see Fig. 1), Ripple & noise tested according to Fig. 2.

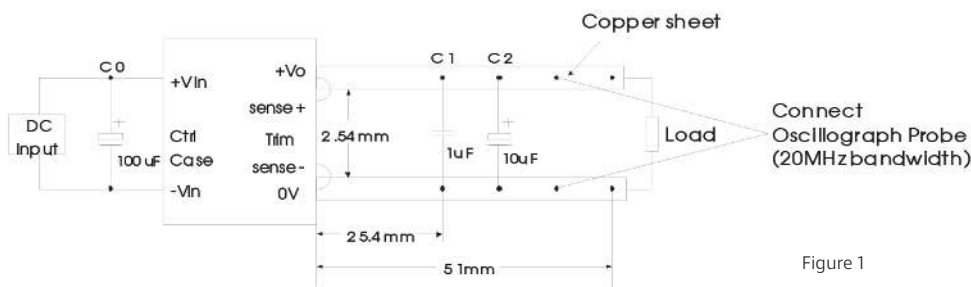
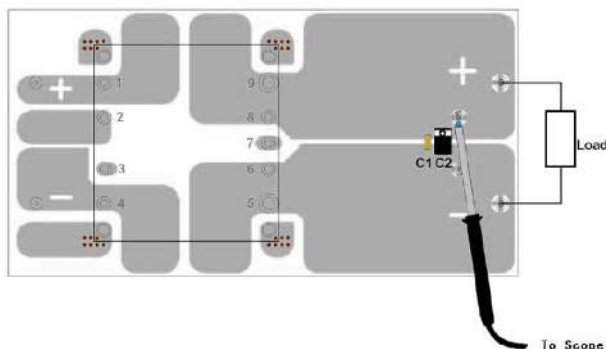

Figure 1



Note: Capacitive value C1:1μF/50V; C2:10μF/35V.

Figure 2

150HBRW4_3 Series

150W Half-Brick - Single Output DC-DC Converter - Wide Input - Isolated & Regulated

Typical application

If not using our EMC recommended circuit, please ensure an 100µF electrolytic capacitors in parallel with the input, which used to suppress the surge voltage come from the input terminal.

If it is required to further reduce input and output ripple, properly increase the input & output of additional capacitors Cin and Cout or select capacitors of low equivalent impedance provided that the capacitance is no larger than the max. capacitive load of the product.



Parameter output voltage	Cout (µF)	Cin (µF)
12V, 15V, 24V	220	100

EMC solution-module recommended circuit

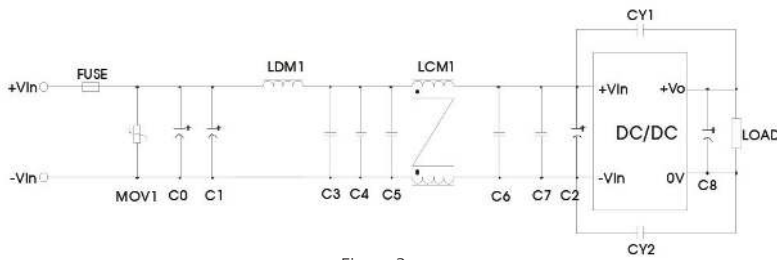
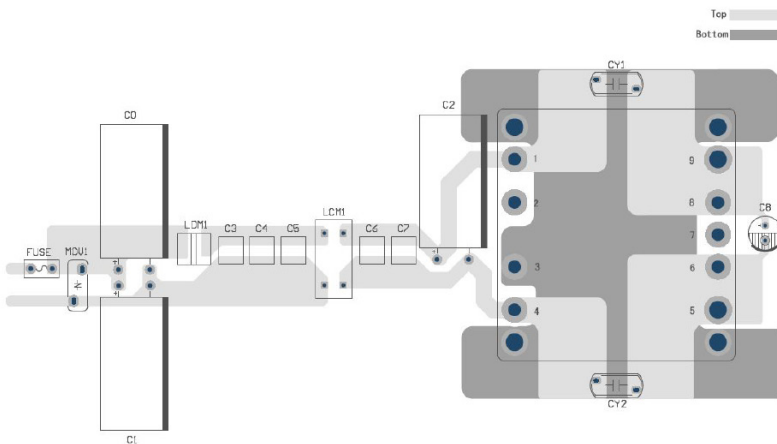

Figure 3

Element model	Recommended value
FUSE	Choose according to actual input current
MOV1	S20K130 (Varistor)
C0	220uF/400V (electrolytic capacitor)
C1/C2	100uF/400V (electrolytic capacitor)
C3/C4/C5/C6/C7	2.2uF/250V
C8	220 uF/50V (electrolytic capacitor)
CY1	2200pF/400VAC (Y Safety capacitor)
CY2	3300pF/400VAC (Y Safety capacitor)
LDM1	10uH (Shielded inductor)
LCM1	1.0mH

EMC solution-module recommended circuit PCB layout



Thermal design

The maximum operating temperature of base-plate TB is 100°C, as long as the user's thermal system keeps TB <100°C, the converter can deliver its full rated power. A power derating curve can be calculated for any heatsink that is attached to the base-plate of the converter. It is only necessary to determine the thermal resistance, Rth(B-A), of the chosen heatsink between the base-plate and then ambient air for a given air-flow rate. This information is usually available from the heatsink vendor. The following formula can be used to determine the maximum power the converter can dissipate for a given thermal condition if its base-plate is to be no higher than 100 °C.

$$P_{diss}^{max} = \frac{100^{\circ}C - T_A}{R_{th(B-A)}} \quad (T_A \text{ is ambient temperature})$$

The maximum load operating power of power supply module at a certain ambient temperature can be calculated by the power dissipation, Formula is as follows:

$$P_{o \max} = \frac{P_{diss}^{max}}{\left(\frac{1}{\eta} - 1\right)} \quad (\eta \text{ is converter efficiency})$$

Therefore, customers can according to the actual application to choose the right heatsink.

150HBRW4_3 Series

150W Half-Brick - Single Output DC-DC Converter - Wide Input - Isolated & Regulated

Trim

Application of Trim and calculation of Trim resistance

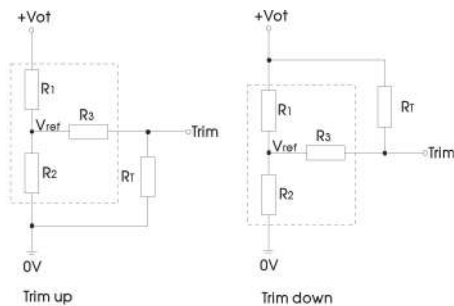

Calculation formula of trim resistance:

$$\begin{aligned} \text{up: } R_T &= \frac{aR_2}{R_2 - a} - R_3 & a &= \frac{V_{ref}}{V_o' - V_{ref}} \cdot R_1 \\ \text{down: } R_T &= \frac{aR_1}{R_1 - a} - R_3 & a &= \frac{V_o' - V_{ref}}{V_{ref}} \cdot R_2 \end{aligned}$$

Note: Value for R1, R2, R3, and Vref refer to the above table
 1. RT: Resistance of Trim.
 a: User-defined parameter, no actual meanings.
 Vo': The trim up/down voltage.

It is not allowed to connect modules output in parallel to enlarge the power.

Applied circuits of Trim (Part in broken line is the interior of models)

Parameter	Vo	Vo	Vo
R1 (KΩ)	11	14.49	24.87
R2 (KΩ)	2.87	2.87	2.87
R3 (KΩ)	17.8	20	20
Vref (V)	2.5	2.5	2.5

Mechanical dimensions

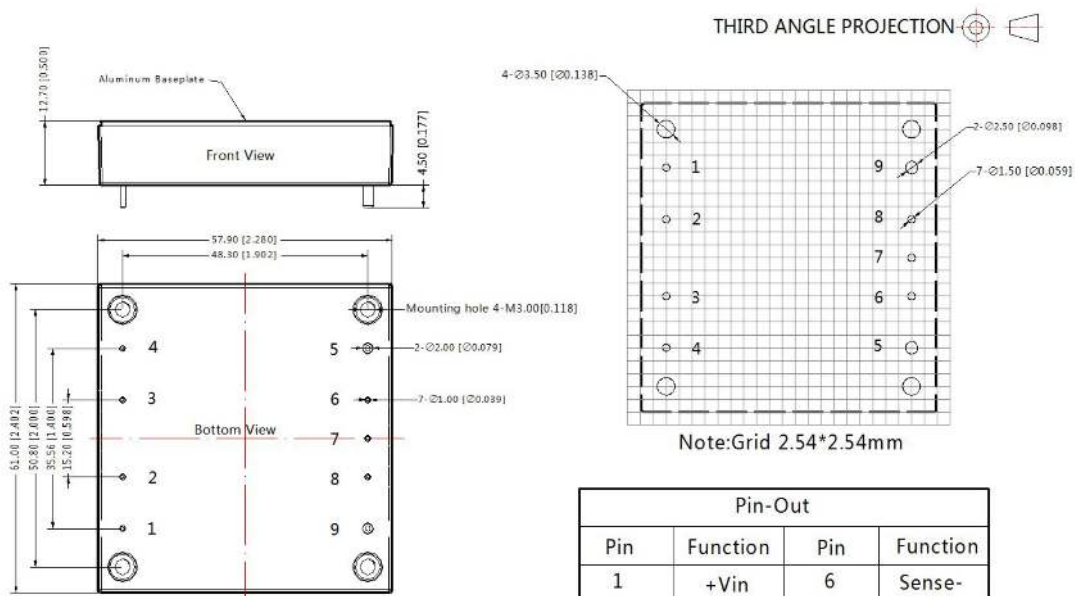

Note:
 Unit:mm[inch]
 Pin1,2,3,4,6,7,8's diameter:1.00[0.039]
 Pin5,9's diameter:2.00[0.079]
 Pin diameter tolerances:±0.10[±0.004]
 General tolerances:±0.50[±0.020]
 Mounting hole screwing torque: Max 0.4 N·m

Pin-Out			
Pin	Function	Pin	Function
1	+Vin	6	Sense-
2	Ctrl	7	Trim
3	Case	8	Sense+
4	-Vin	9	+Vo
5	0V		

150HBRW4_3 Series

150W Half-Brick - Single Output DC-DC Converter - Wide Input - Isolated & Regulated

Mechanical dimensions with heatsink

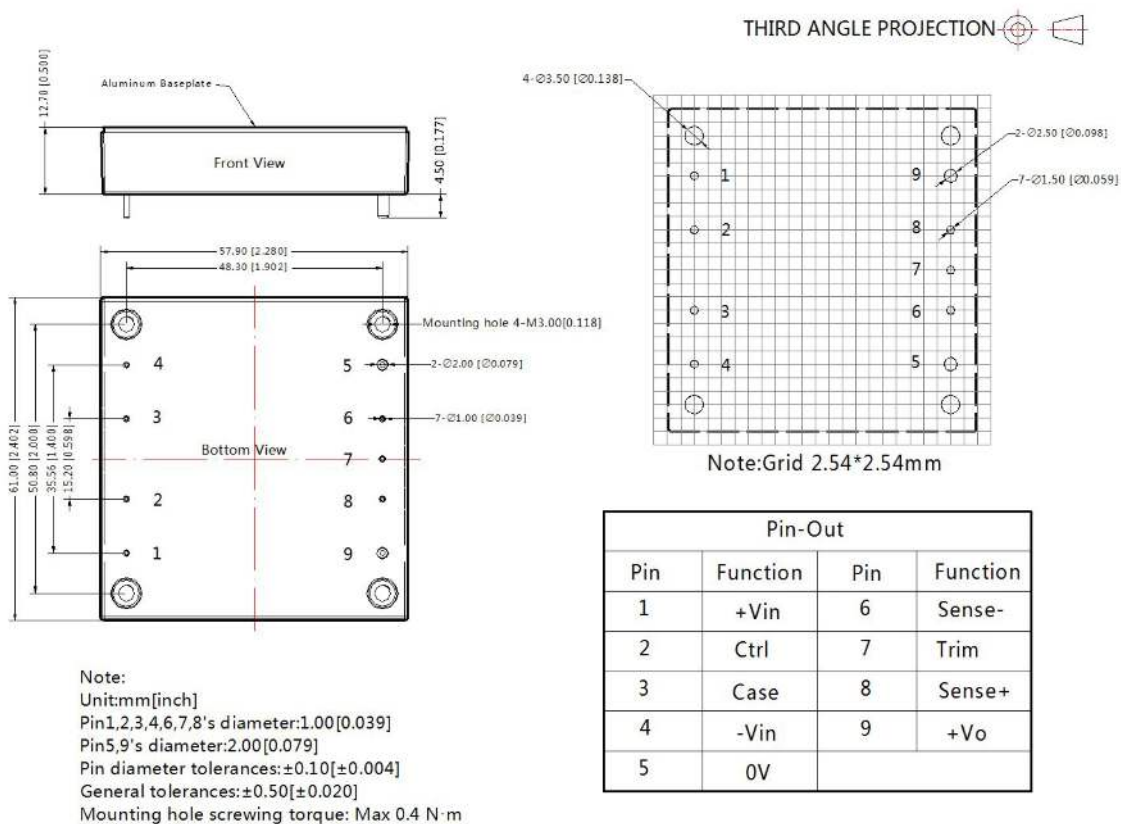

Note:

1. The max capacitive load should be tested within the input voltage range and under full load conditions;
2. Recommends that customers plus silicone film or thermal grease between the module and the heatsink, in order to ensure good heat dissipation;
3. Unless otherwise specified, parameters in this datasheet were measured under the conditions of Ta=25°C, humidity<75% with nominal input voltage and rated output load;
4. when used in lower than 10% load, the ripple & noise index of the product is 3%Vo;
5. All index testing methods in this datasheet are based on our Company's corporate standards;
6. The performance parameters of the product models listed in this manual are as above, but some parameters of non-standard model products may exceed the requirements mentioned above. Please contact our technicians directly for specific information;
7. We can provide product customization service;
8. Specifications are subject to change without prior notice.