

Features

- High speed 1Mbit/s
- 15kV/ μ s minimum common mode transient immunity at $V_{CM} = 1500V$ (HCPL0453)
- High isolation voltage between input and output ($V_{iso} = 3750 V_{rms}$)
- Guaranteed performance from 0°C to 70°C
- Wide operating temperature range of -55°C to 100°C
- Pb free and RoHS and Halogen free compliant
- cUL approved (No. E214129)
- VDE approved (No. 40028116)
- SEMKO approved
- NEMKO approved
- DEMKO approved
- FIMKO approved

Description

The EL0500, EL0501, EL0452 and EL0453 devices each consist of an infrared emitting diode, optically coupled to a high speed photo detector transistor. A separate connection for the photodiode bias and output-transistor collector increase the speed by several orders of magnitude over conventional phototransistor couplers by reducing the base-collector capacitance of the input transistor.

The devices are packaged in an 8-pin small outline package which conforms to the standard SO-8 footprint.

Applications

- Line receivers
- Telecommunication equipments
- Power transistor isolation in motor drives
- Replacement for low speed phototransistor photo couplers
- Feedback loop in switch-mode power supplies
- Home appliances
- High speed logic ground isolation

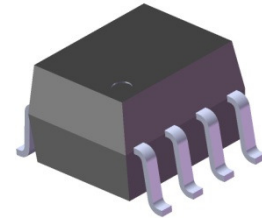

Schematic

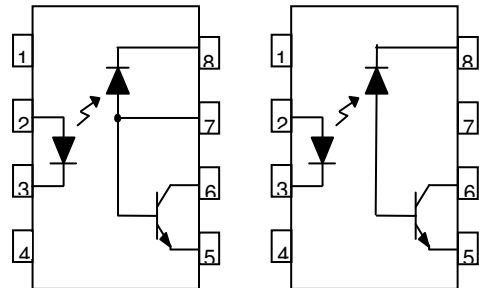

EL0500 / EL0501

EL0452 / EL0453

Pin Configuration

1. No Connection
2. Anode
3. Cathode
4. No Connection
5. Gnd
6. Vout

Pin Configuration

1. No Connection
2. Anode
3. Cathode
4. No Connection
5. Gnd
6. Vout

Absolute Maximum Ratings ($T_a=25^\circ\text{C}$)

Parameter		Symbol	Rating	Unit
Input	Forward current	I_F	25	mA
	Peak forward current (50% duty, 1ms P.W)	I_{FP}	50	mA
	Peak transient current ($\leq 1\mu\text{s}$ P.W, 300pps)	I_{Ftrans}	1	A
	Reverse voltage	V_R	5	V
	Power dissipation	P_{IN}	45	mW
Output	Power dissipation	P_O	100	mW
	Emitter-Base reverse voltage	EL0500 EL0501 V_{EBR}	5	V
	Base current	EL0500 EL0501 I_B	5	mA
	Average Output current	$I_{O(AVG)}$	8	mA
	Peak Output current	$I_{O(PK)}$	16	mA
	Output voltage	V_O	-0.5 to 20	V
	Supply voltage	V_{CC}	-0.5 to 30	V
Isolation voltage ^{*1}		V_{ISO}	3750	V rms
Operating temperature		T_{OPR}	-55 ~ +100	$^\circ\text{C}$
Storage temperature		T_{STG}	-55 ~ +125	$^\circ\text{C}$
Soldering temperature ^{*2}		T_{SOL}	260	$^\circ\text{C}$

Notes

*1 AC for 1 minute, R.H.= 40 ~ 60% R.H. In this test, pins 1, 2, 3, 4 are shorted together, and pins 5, 6, 7, 8 are shorted together.

*2 For 10 seconds.

Electrical Characteristics ($T_A=0$ to 70°C unless specified otherwise)

Input

Parameter	Symbol	Min.	Typ.*	Max.	Unit	Conditions
Forward voltage	V_F	-	1.5	1.8	V	$I_F = 16\text{mA}$
Reverse Voltage	V_R	5.0	-	-	V	$I_R = 10\mu\text{A}$
Temperature coefficient of forward voltage	$\Delta V_F/\Delta T_A$	-	-1.6	-	mV/ $^\circ\text{C}$	$I_F = 16\text{mA}$

Output

Parameter	Symbol	Min.	Typ.*	Max.	Unit	Conditions
Logic High Output Current	I_{OH}	-	0.001	0.5	μA	$I_F=0\text{mA}, V_O=V_{CC}=5.5\text{V}, T_A=25^\circ\text{C}$
		-	0.01	1		$I_F=0\text{mA}, V_O=V_{CC}=15\text{V}, T_A=25^\circ\text{C}$
		-	-	50		$I_F=0\text{mA}, V_O=V_{CC}=15\text{V}$
Logic Low Supply Current	I_{CCL}	-	140	200	μA	$I_F=16\text{mA}, V_O=\text{Open}, V_{CC}=15\text{V}$
Logic High Supply Current	I_{CCH}	-	0.01	1	μA	$I_F=0\text{mA}, V_O=\text{Open}, V_{CC}=15\text{V}, T_A=25^\circ\text{C}$
		-	-	2		$I_F=0\text{mA}, V_O=\text{Open}, V_{CC}=15\text{V}$

* Typical values at $T_A = 25^\circ\text{C}$

Transfer Characteristics ($T_A=0$ to 70°C unless specified otherwise)

Parameter		Symbol	Min.	Typ.*	Max.	Unit	Conditions
Current Transfer Ratio	EL0500	CTR	7	-	50	%	$I_F = 16\text{mA}, V_O = 0.4\text{V}, V_{CC}=4.5\text{V}, T_A=25^\circ\text{C}$
	EL0501 EL0452 EL0453		19	-	50		
	EL0500		5	-	-		$I_F = 16\text{mA}, V_O = 0.5\text{V}, V_{CC}=4.5\text{V}$
	EL0501 EL0452 EL0453		15	-	-		
Logic Low Output Voltage	EL0500	V_{OL}	-	0.18	0.4	V	$I_F = 16\text{mA}, I_O = 1.1\text{mA}, V_{CC}=4.5\text{V}, T_A=25^\circ\text{C}$
	EL0501 EL0452 EL0453		-	0.18	0.4		$I_F = 16\text{mA}, I_O = 3\text{mA}, V_{CC}=4.5\text{V}, T_A=25^\circ\text{C}$
	EL0500		-	-	0.5		$I_F = 16\text{mA}, I_O = 0.8\text{mA}, V_{CC}=4.5\text{V}$
	EL0501 EL0452 EL0453		-	-	0.5		$I_F=16\text{mA}, I_O=2.4\text{mA}, V_{CC}=4.5\text{V}$

* Typical values at $T_A = 25^\circ\text{C}$

Switching Characteristics ($T_A=0$ to 70°C unless specified otherwise, $I_F=16\text{mA}$, $V_{CC}=5\text{V}$)

Parameter		Symbol	Min.	Typ.*	Max.	Unit	Conditions
Propagation Delay Time to Logic Low (Fig.8)	EL0500	TPHL	-	-	1.5	μs	$R_L=4.1\text{K}\Omega$, $T_A=25^\circ\text{C}$
			-	-	2.0		$R_L=4.1\text{K}\Omega$
	EL0501 EL0452 EL0453		-	-	0.8		$R_L=1.9\text{K}\Omega$, $T_A=25^\circ\text{C}$
			-	-	1.0		$R_L=1.9\text{K}\Omega$
Propagation Delay Time to Logic High (Fig.8)	EL0500	TPLH	-	-	1.5	μs	$R_L=4.1\text{K}\Omega$, $T_A=25^\circ\text{C}$
			-	-	2.0		$R_L=4.1\text{K}\Omega$
	EL0501 EL0452 EL0453		-	-	0.8		$R_L=1.9\text{K}\Omega$, $T_A=25^\circ\text{C}$
			-	-	1.0		$R_L=1.9\text{K}\Omega$
Common Mode Transient Immunity at Logic High (Fig.9) ³	EL0500	CM_H	-	1,000	-	$\text{V}/\mu\text{s}$	$I_F = 0\text{mA}$, $V_{CM}=10\text{Vp-p}$, $R_L=4.1\text{K}\Omega$, $T_A = 25^\circ\text{C}$
	EL0452 EL0501		-	1,000	-		$I_F = 0\text{mA}$, $V_{CM}=10\text{Vp-p}$, $R_L=1.9\text{K}\Omega$, $T_A = 25^\circ\text{C}$
	EL0453		15000	-	-		$I_F = 0\text{mA}$, $V_{CM}=1500\text{Vp-p}$, $R_L=1.9\text{K}\Omega$, $T_A = 25^\circ\text{C}$
Common Mode Transient Immunity at Logic Low (Fig.9) ³	EL0500	CM_L	-	1,000	-	$\text{V}/\mu\text{s}$	$I_F = 16\text{mA}$, $V_{CM}=10\text{Vp-p}$, $R_L=4.1\text{K}\Omega$, $T_A = 25^\circ\text{C}$
	EL0452 EL0501		-	1,000	-		$I_F = 16\text{mA}$, $V_{CM}=10\text{Vp-p}$, $R_L=1.9\text{K}\Omega$, $T_A=25^\circ\text{C}$
	EL0453		15000	-	-		$I_F = 16\text{mA}$, $V_{CM}=1500\text{Vp-p}$, $R_L=1.9\text{K}\Omega$, $T_A=25^\circ\text{C}$

* Typical values at $T_A = 25^\circ\text{C}$

Typical Performance Curves

Figure 1. Forward Current vs Forward Voltage

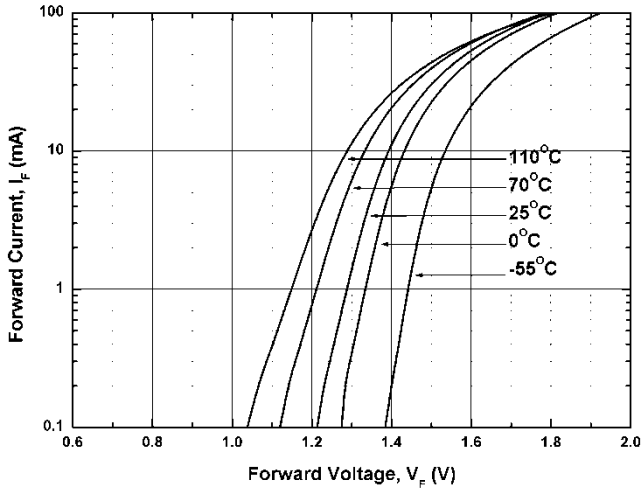

Figure 2. Current Transfer Ratio vs Forward Current

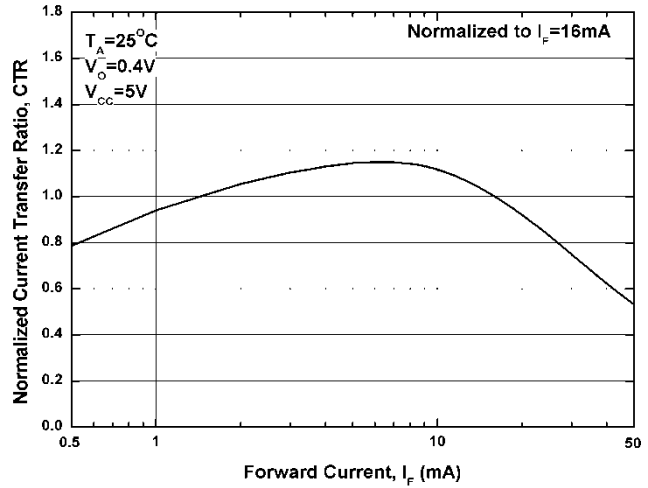

Figure 3. Current Transfer Ratio vs Ambient Temperature

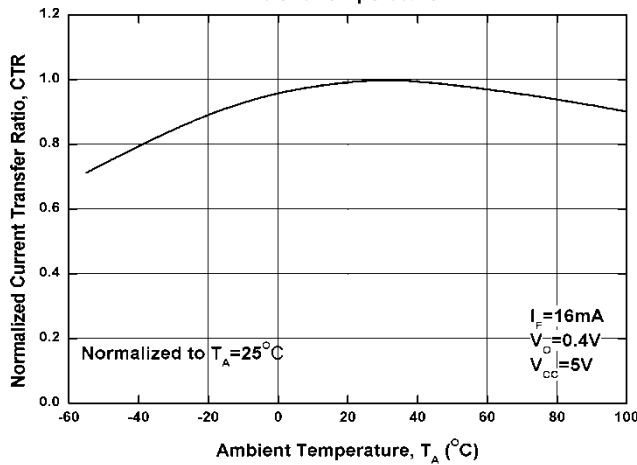

Figure 4. Output Current vs Output Voltage

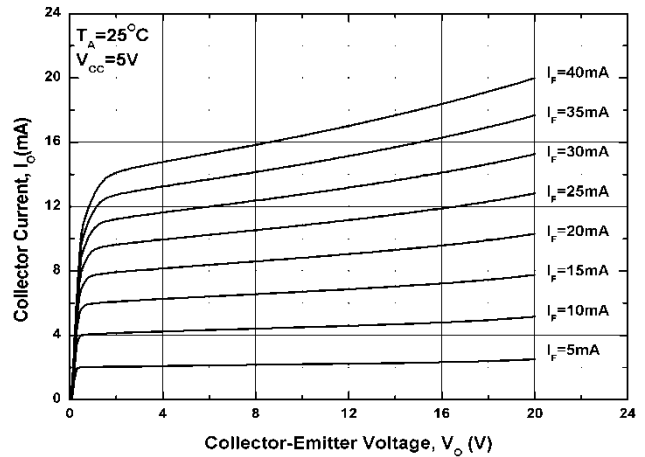

Figure 5. Logic High Output Current vs Ambient Temperature

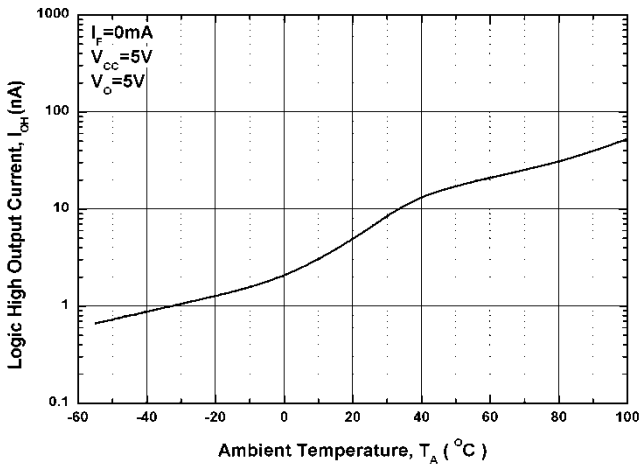

Figure 6. Propagation Delay vs Load Resistance

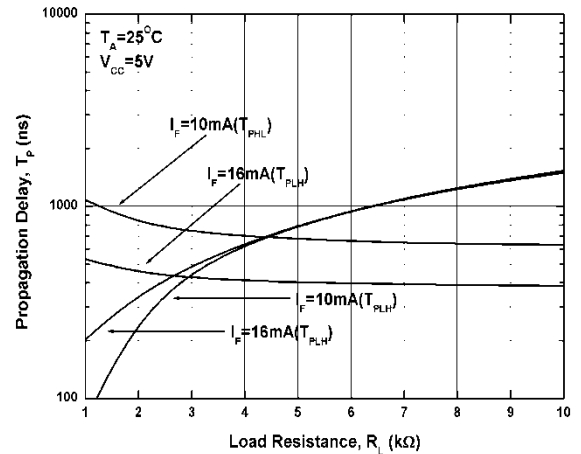

Figure 7. Propagation Delay vs. Temperature

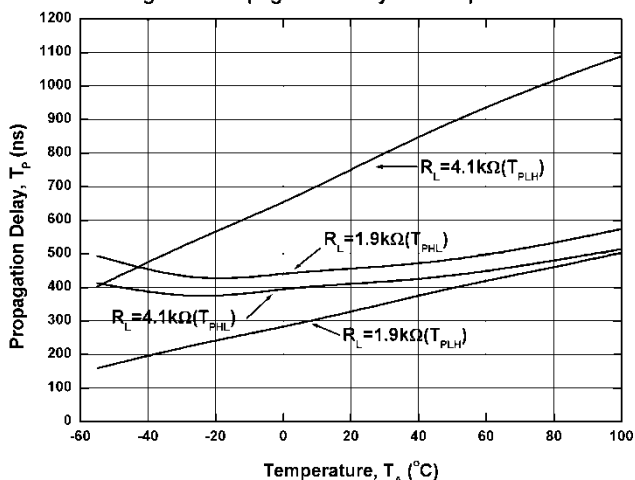

Figure 8 Switching Time Test Circuit & Waveform

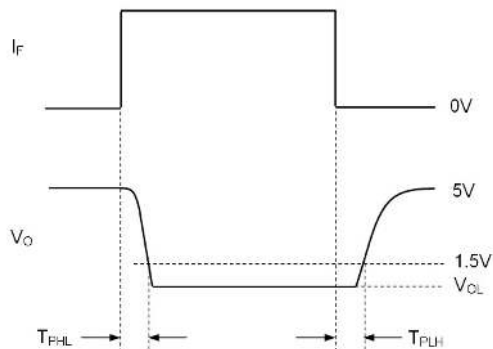
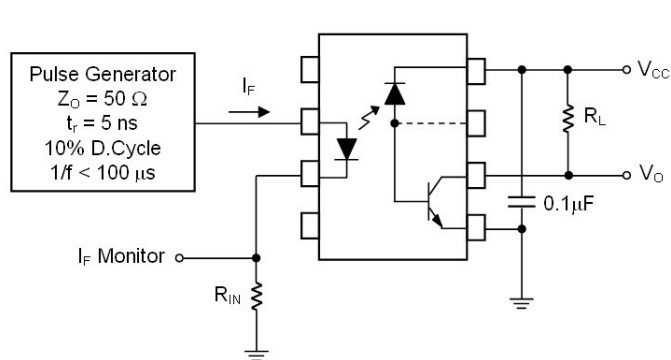
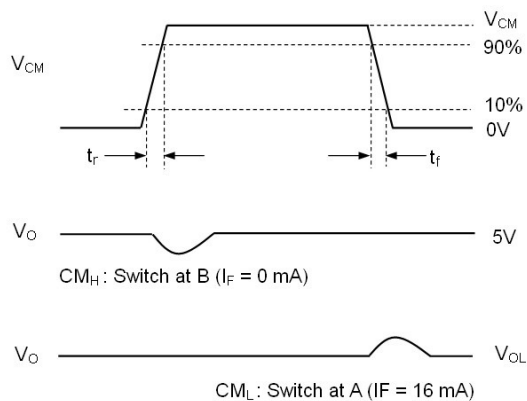
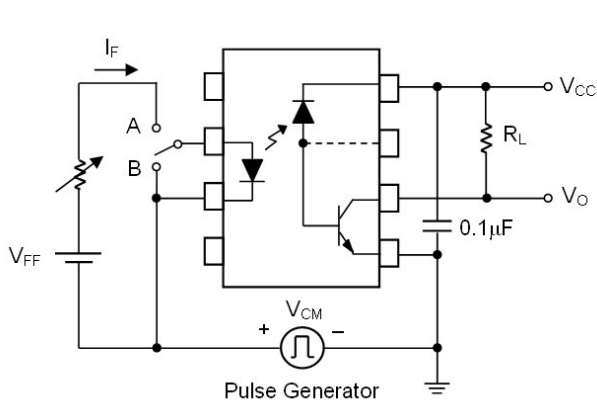

Figure 9 Transient Immunity Test Circuit &



Note:

*3 Common mode transient immunity in logic high level is the maximum tolerable (positive) dV_{cm}/dt on the leading edge of the common mode pulse signal VCM, to assure that the output will remain in a logic high state (i.e., $V_O > 2.0V$).

Common mode transient immunity in logic low level is the maximum tolerable (negative) dV_{cm}/dt on the trailing edge of the common mode pulse signal, VCM, to assure that the output will remain in a logic low state (i.e., $V_O < 0.8V$).

Order Information**Part Number****EL050X(Z)-V**

Or

EL045X(Z)-V**Note**

- X = Part No. (X = 0 or 1) for EL050x; (x=2 or 3) for EL045x
- Z = Tape and reel option (TA, TB or none)
- V = VDE (optional)

Option	Description	Packing quantity
None	Standard	100 units per tube
-V	Standard + VDE	100 units per tube
(TA)	TA tape & reel option	2000 units per reel
(TB)	TB tape & reel option	2000 units per reel
(TA)-V	TA tape & reel option + VDE	2000 units per reel
(TB)-V	TB tape & reel option + VDE	2000 units per reel

Package Drawing (Dimensions in mm)

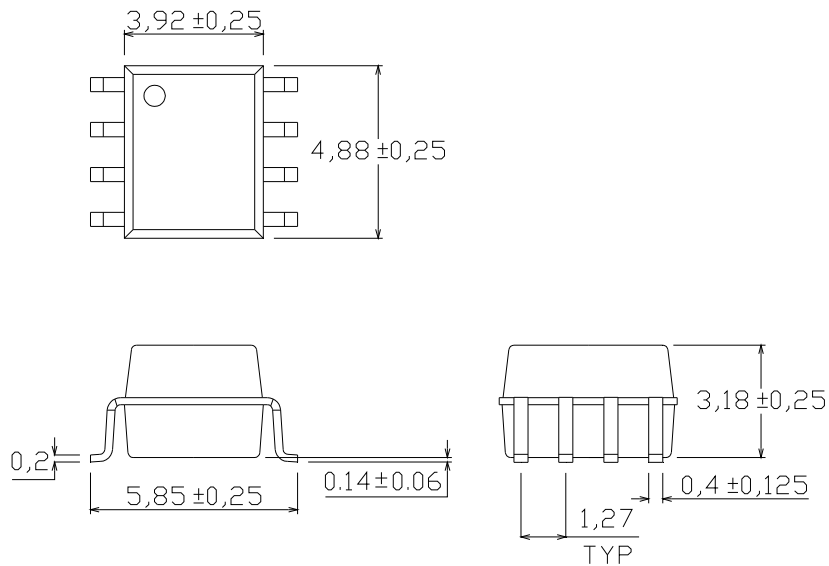

Recommended pad layout for surface mount leadform

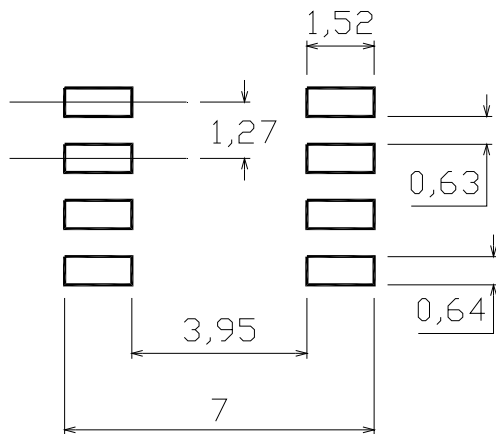

Device Marking

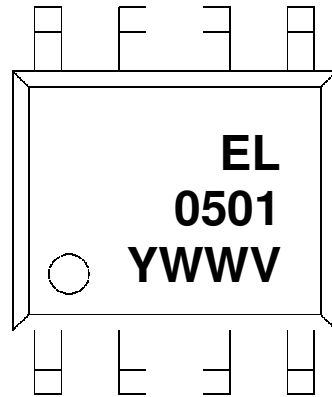

Notes

EL	denotes EVERLOGHT
0501	denotes Device Number
Y	denotes 1 digit Year code
WW	denotes 2 digit Week code
V	denotes VDE (optional)

Tape & Reel Packing Specifications

Option TA

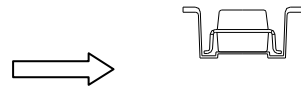
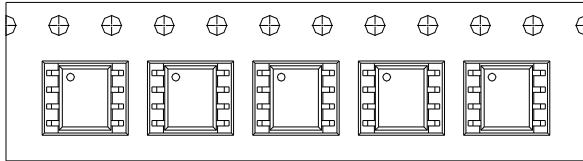

Direction of feed from reel

Option TB

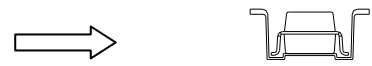
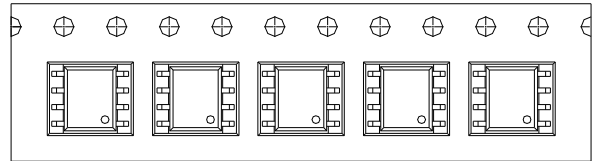

Direction of feed from reel

Tape dimensions

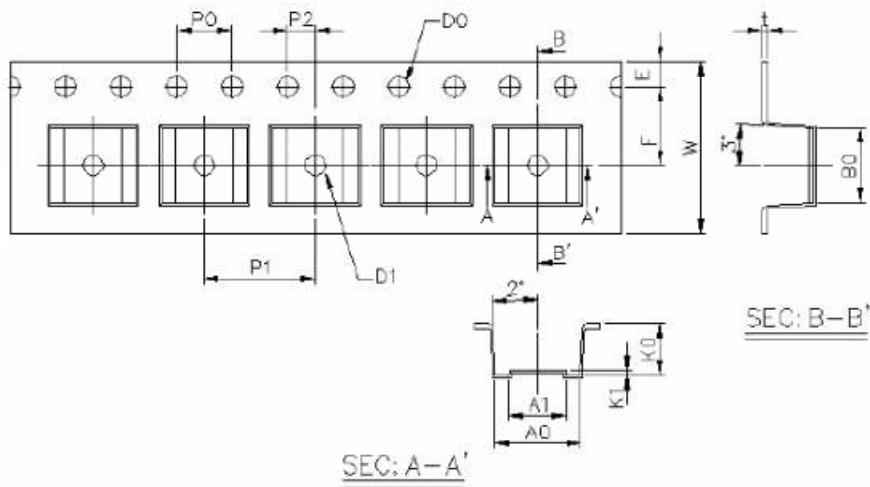

Dimension No.	A0	A1	B0	D0	D1	E	F
Dimension(mm)	6.2±0.1	4.1±0.1	5.28±0.1	1.5±0.1	1.5±0.3	1.75±0.1	5.5±0.1
Dimension No.	Po	P1	P2	t	W	K0	K1
Dimension(mm)	4.0±0.1	8.0±0.1	2.0±0.1	0.4±0.1	12.0+0.3/ -0.1	3.7±0.1	0.3±0.1

Solder Reflow Temperature Profile

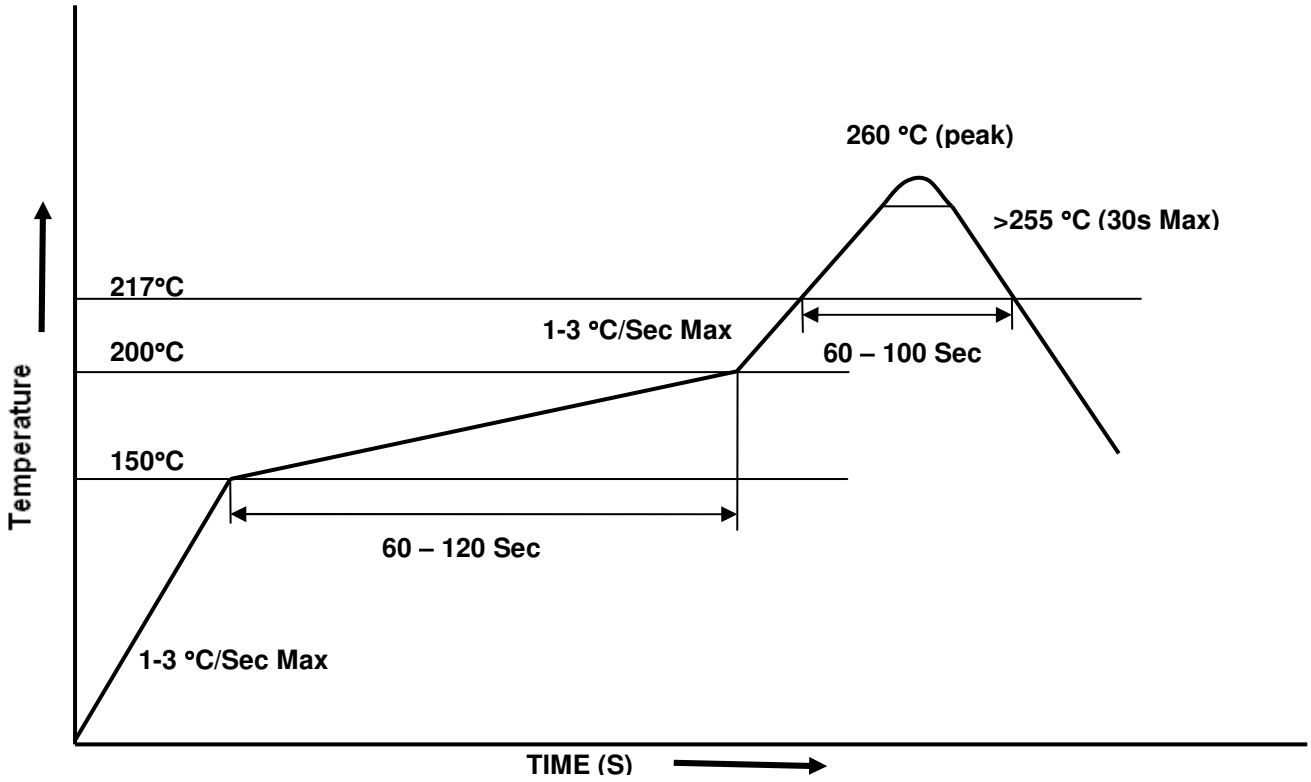

DISCLAIMER

1. Above specification may be changed without notice. EVERLIGHT will reserve authority on material change for above specification.
2. When using this product, please observe the absolute maximum ratings and the instructions for using outlined in these specification sheets. EVERLIGHT assumes no responsibility for any damage resulting from use of the product which does not comply with the absolute maximum ratings and the instructions included in these specification sheets.
3. These specification sheets include materials protected under copyright of EVERLIGHT corporation. Please don't reproduce or cause anyone to reproduce them without EVERLIGHT's consent.