

## Features

- Integrated Transient Voltage Suppressor (TVS) in the Transceiver IC
- TVS Protection for Bus Terminals :  
±15 kV IEC 61000-4-2, Contact Discharge  
±18 kV IEC 61000-4-2, Air-Gap Discharge  
±15 kV EIA/JEDEC Human Body Model
- HBM ±8kV ESD Protection for all pins
- MM ±800V ESD Protection for all pins
- Latchup immunity up to ±400mA for all pins.
- High CDM protection up to ±1kV for all pins.
- Meet the Requirements of the EIA/TIA-485 Standards with 3.3V Power Supply
- True Fail-Safe Receiver While Maintaining EIA/TIA-485 Compatibility
- Data Rate up to 16Mbps
- Hot-Swap Glitch free Protection on Control Inputs
- Up to 256 Transceivers on the Bus

## Applications

- Telecommunications Equipment
- Security System
- Building Automation Networks

## Description

The AZRS3078 is a ±15kV IEC 61000-4-2 contact discharge protected half-duplex RS485 transceiver IC, which contains one transmitter and one receiver inside. This device is fully compliant with the EIA/TIA-485 standard with 3.3V power supply.

The AZRS3078 features a fail-safe receiver, which guarantees the output of the receiver to be logic high when the differential inputs (bus pins, A and B) of the receiver are open, short or idle under abnormal operating conditions.

The AZRS3078 features a hot-swap glitch-free which guarantees outputs of the transmitter and the receiver in a high impedance state and even no short current event during the power up period. The AZRS3078 has the thermal shutdown and the current limited function in the transmitter to protect the device from damage by system fault conditions during normal operating condition. The AZRS3078 is designed 1/8 unit load with minimum 96kohm of input impedance, which can connect 256 devices on a bus at least. The AZRS3078 is also a high reliable device with built-in system level ESD protected devices against high-energy noise transients without requiring any external components.

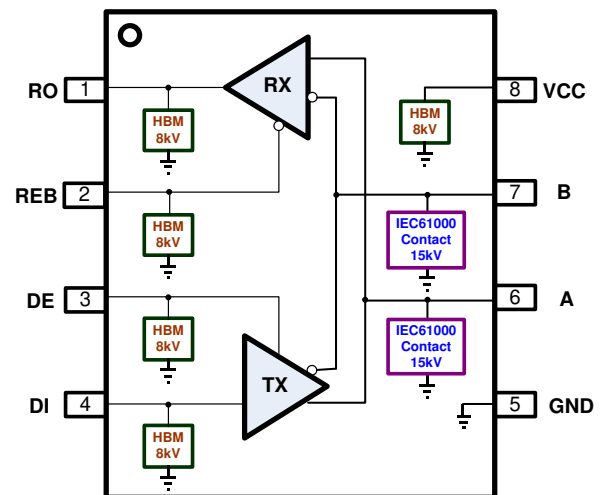

**Functional Block of AZRS3078**

Part Number	Duplex	Tx/Rx	Supply	Max Data Rate (Mbps)	Fail- safe	HBM on A,B	IEC 61000-4-2 Contact on A,B	Package Type
AZRS3078	Half	1/1	3.3V	16	Yes	±15kV	± 15kV	SOP8



## ABSOLUTE MAXIMUM RATINGS

PARAMETER	PARAMETER	RATING	UNITS
Power Supply Vcc	Vcc	-0.3 to 8.0	V
Control Input Voltage	REB, DE	-0.3 to (Vcc+ 0.3)	V
Receiver Input Voltage	A, B	±13	V
Receiver Output Voltage	RO	-0.3 to (Vcc+ 0.3)	V
Transmitter Output Voltage	A, B	±13	V
Transmitter Input	DI	-0.3 to (Vcc+ 0.3)	V
Operating Temperature	T <sub>OP</sub>	-40 to +85	°C
Storage Temperature	T <sub>STO</sub>	-65 to +150	°C

## DC ELECTRICAL CHARACTERISTICS

(Vcc=3.3V±5% with T<sub>AMB</sub>= T<sub>MIN</sub> to T<sub>MAX</sub>, unless otherwise noted. Typical values are at Vcc=3.3V and T<sub>AMB</sub>= 25 °C.)

PARAMETER	SYMBOL	CONDITIONS	MIN	TYP	MAX	UNITS
<b>Transmitter</b>						
Differential Transmitter Output	V <sub>OD1</sub>	No load			Vcc	V
Differential Transmitter Output	V <sub>OD2</sub>	Fig.1, R <sub>L</sub> = 27 Ω	1.5			V
Change in Magnitude of Differential Output Voltage	ΔV <sub>OD</sub>	Fig.1, R <sub>L</sub> = 27 Ω			0.2	V
Transmitter Common- Mode Output Voltage	V <sub>OC</sub>	Fig.1, R <sub>L</sub> = 27 Ω			3	V
Change in Magnitude of Common- Mode Voltage	ΔV <sub>OC</sub>	Fig.1, R <sub>L</sub> = 27 Ω			0.2	V
Input High Voltage	V <sub>IH</sub>	DE, DI, REB	2.0			V
Input Low Voltage	V <sub>IL</sub>	DE, DI, REB			0.8	V
Input Current	I <sub>IN1</sub>	DE, DI, REB			±2	μA
Input Current for A and B	I <sub>IN2</sub>	DE=0, Vcc=0V or 3.6V	V <sub>IN</sub> =12V		125	μA
			V <sub>IN</sub> =-7V	-100		
Transmitter Short-Circuit Output Current	I <sub>OSD</sub>	-7V ≤ V <sub>OUT</sub> ≤ 12V	-250		250	mA



PARAMETER	SYMBOL	CONDITIONS	MIN	TYP	MAX	UNITS
<b>RECEIVER</b>						
Receiver Differential Threshold Voltage	$V_{TH}$	$-7V \leq V_{CM} \leq +12V$	-200		-50	mV
Receiver Output High Voltage	$V_{OH}$	$I_o = -4mA, V_{ID} = 200mV$	$V_{CC} - 0.6$			V
Receiver Output Low Voltage	$V_{OL}$	$I_o = 4mA, V_{ID} = -200mV$			0.4	V
Three- State Output Current at Receiver	$I_{OZR}$	$0 \leq V_o \leq V_{CC}$			$\pm 1$	$\mu A$
Receiver Input Resistance	$R_{IN}$	$-7V \leq V_{CM} \leq +12V$	96			$k\Omega$
Receiver Output Short-Circuit Current	$I_{OSR}$	Fig. 6, $0V \leq V_{RO} \leq V_{CC}$			$\pm 80$	mA
<b>SUPPLY CURRENT</b>						
Supply Current	$I_{CC}$	No load, REB=0, DE= $V_{CC}$		0.3	1.0	mA
		No load, REB= $V_{CC}$ , DE= $V_{CC}$		0.3	1.0	mA
		No load, REB=0, DE= 0		0.3	1.0	mA
Supply Current in Shutdown Mode	$I_{SHDN}$	REB= $V_{CC}$ , DE= 0			10	$\mu A$
<b>ESD PROTECTION</b>						
ESD Protection for A and B		Human Body Model (HBM)		15		kV
		Contact (IEC 61000-4-2)		15		kV
		Air (IEC 61000-4-2)		18		kV

## SWITCHING CHARACTERISTICS

( $V_{CC} = 3.3V \pm 5\%$  with  $T_{AMB} = T_{MIN}$  to  $T_{MAX}$ , unless otherwise noted. Typical values are at  $V_{CC} = 3.3V$  and  $T_{AMB} = 25^\circ C$ .)

PARAMETER	SYMBOL	CONDITIONS	MIN	TYP	MAX	UNITS
<b>Transmitter</b>						
Transmitter Propagation Delay	$t_{DPLH}, t_{DPHL}$	Fig.2, Fig.7, $R_{DIFF} = 54\Omega$ , $C_{L1} = C_{L2} = 100pF$			50	ns
Transmitter Output Skew $ t_{DPLH} - t_{DPHL} $	$t_{DSKEW}$	Fig.2, Fig.7, $R_{DIFF} = 54\Omega$ , $C_{L1} = C_{L2} = 100pF$			8	ns
Transmitter Rise or Fall Time	$t_{DF}, t_{DR}$	Fig.2, Fig.7, $R_{DIFF} = 54\Omega$ , $C_{L1} = C_{L2} = 100pF$			15	ns
Data Rate	$f_{Data}$	Duty cycle 40% ~ 60%		16		Mbps



Transmitter Enable to Output Low	$t_{DZL}$	Fig.4, Fig.8, $C_{DL}= 50pF$ , S1 closed			150	ns
Transmitter Enable to Output High	$t_{DZH}$	Fig.4, Fig.8, $C_{DL}= 50pF$ , S2 closed			150	ns
Transmitter Disable Time from Low	$t_{DLZ}$	Fig.4, Fig.8, $C_{DL}= 50pF$ , S1 closed			100	ns
Transmitter Disable Time from High	$t_{DHZ}$	Fig.4, Fig.8, $C_{DL}= 50pF$ , S2 closed			100	ns
Transmitter Enable from Shutdown to Output Low	$t_{DZL(SHDN)}$	Fig.4, Fig.8, $C_{DL}= 50pF$ , S1 closed			1800	ns
Transmitter Enable from Shutdown to Output High	$t_{DZH(SHDN)}$	Fig.4, Fig.8, $C_{DL}= 50pF$ , S2 closed			1800	ns
Time to shutdown	$t_{SHDN}$		50	200	600	ns
<b>Receiver</b>						
Receiver Input to Output	$t_{RPLH}, t_{RPHL}$	Fig.5, Fig.9, $ V_{ID}  \geq 2.0V$ ; rise and fall time of $V_{ID} \leq 15ns$		40	75	ns
$ t_{RPLH} - t_{RPH} $ Different Receiver Skew	$t_{RSKD}$	Fig.5, Fig.9, $ V_{ID}  \geq 2.0V$ ; rise and fall time of $V_{ID} \leq$			8	ns
Data Rate	$f_{Data}$			16		Mbps
Receiver Enable to Output Low	$t_{RZL}$	Fig.3, Fig.10, $C_{RL}= 15pF$ , S1 closed			50	ns
Receiver Enable to Output High	$t_{RZH}$	Fig.3, Fig.10, $C_{RL}= 15pF$ , S2 closed			50	ns
Receiver Disable Time from Low	$t_{RLZ}$	Fig.3, Fig.10, $C_{RL}= 15pF$ , S1 closed			50	ns
Receiver Disable Time from High	$t_{RHZ}$	Fig.3, Fig.10, $C_{RL}= 15pF$ , S2 closed			50	ns
Receiver Enable from Shutdown to Output Low	$t_{RZL(SHDN)}$	Fig.3, Fig.10, $C_{RL}= 15pF$ , S1 closed			1800	ns
Receiver Enable from Shutdown to Output High	$t_{RZH(SHDN)}$	Fig.3, Fig.10, $C_{RL}= 15pF$ , S2 closed			1800	ns
Time to shutdown	$t_{SHDN}$		50	200	600	ns



## PIN FUNCTION DESCRIPTION

Pin Number	Mnemonic	Function
1	RO	Receiver Output: When REB is low and if $(A - B) \geq -50\text{mV}$ , RO is high; if $(A - B) \leq -200\text{mV}$ , RO is low.
2	REB	Receiver Output Enable: REB is low to enable the Receiver; REB is high to disable the Receiver.
3	DE	Transmitter Output Enable: DE is high to enable the transmitter; DE is low to disable the transceiver.
4	DI	Transmitter Input: When DE is high, a low on DI forces A output low and B output high. Similarly, a high on DI forces A output high and B output low.
5	GND	Ground.
6	A	Non-inverting Receiver Input and Non-inverting Transmitter Output.
7	B	Inverting Receiver Input and Inverting Transmitter Output.
8	VCC	Power Supply Input 3.3V.

## FUNCTION TABLE

TRANSMITTING				
INPUTS			OUTPUTS	
REB	DE	DI	A	B
X	1	0	0	1
X	1	1	1	0
0	0	X	High- Z	High- Z
1	0	X	Shutdown	

X= Don't care  
HIGH- Z= High impedance

RECEIVING			
INPUTS			OUTPUTS
REB	DE	A - B	RO
0	X	$\geq -0.05\text{V}$	1
0	X	$\leq -0.2\text{V}$	0
0	X	Open/Shorted	1
1	1	X	High- Z
1	0	X	Shutdown

X= Don't care  
HIGH- Z= High impedance



## Detail Description

The AZRS3078 is a half-duplex RS-485 transceiver IC with IEC61000-4-2 contact  $\pm 15\text{kV}$  ESD protection for bus pins (A and B), which contains one transmitter and one receiver inside with 3.3V power supply. This device is fully compliant with the EIA/TIA-485 standard.

The AZRS3078 features the hot-swap glitch free design which guarantees the outputs of the transceiver in a high impedance state during the power-up period until the supply voltage has stabilized.

The AZRS3078 with whole chip ESD protected design for all of the I/O pins has robust ESD protection up to both HBM  $\pm 8\text{kV}$  and MM  $\pm 800\text{V}$ . Moreover, the latchup immunity of the AZRS3078 is up to  $\pm 400\text{mA}$  for all of the pins. For IC self discharge issue, the CDM protection level of the AZRS3078 is up to  $\pm 1\text{kV}$ .

## Transmitter

The design of the transmitter is a non-inverted translator that converts the single-ended TTL input signal to differential EIA/TIA-485 signal level. The transmitter of the AZRS3078 guarantees 16Mbps data rate communication. When the transmitter is active (DE= HIGH), the single-end TTL input signals of transmitter will be transported to differential output RS485 signals of the transmitter. Under the disable state (DE= LOW), the outputs of transmitter keep at high impedance state. The differential output voltage (VA-VB) of the AZRS3078 is at least 1.5V with 54 ohm load under  $T = 25^\circ\text{C}$ .

## Receiver

The receiver of the AZRS3078 converts the differential EIA/TIA-485 signals to single-end output TTL signal when receiver is in active state (REB=LOW). When the receiver is disable (REB=HIGH), the output of the receiver keeps in high impedance state no matter what receiver input.

## True Fail-Safe

In traditional design, the fail-safe function is implemented by resistors on the PCB. One resistor is terminated pin A to VCC; the other is terminated pin B to GND to keep RO at high state when bus is idle, which is only the open fail-safe. The AZRS3078 guarantees a receiver output high when the receiver inputs are short, open or idle, that is true fail-safe. The threshold voltage of receiver input is between  $-50\text{mV}$  and  $-200\text{mV}$ . If the differential input voltage (A - B) of receiver is greater than or equal to  $-50\text{mV}$ , receiver output (RO) is logic-high. If (A - B) is less than or equal to  $-200\text{mV}$ , RO is logic-low. In the case of a terminated bus with all transmitters disabled, the receiver's differential input voltage (A - B) is 0V, so the RO is logic-high at that time.

## 1/8 Unit Load

The RS-485 standard defines both receiver inputs impedance are  $12\text{k}\Omega$  (1 unit load) and the maximum 32-unit loads on the bus. The AZRS3078 transceiver has a  $96\text{k}\Omega$  input impedance (1/8 unit load) of the receiver, allowing up to 256 or fewer devices to be connected in parallel on the RS485 bus.

## Transmitter Output Protection

The AZRS3078 has the current limitation function and the thermal shutdown protection in the transmitter. Firstly, the function of current limitation provides immediate protection against short circuits over the whole common-mode voltage range ( $-7\text{V}$  to  $+12\text{V}$ ). Secondly, the function of thermal shutdown protection forces the transmitter outputs into a high impedance state if the die temperature becomes excessive.

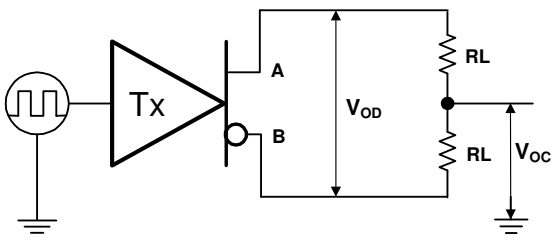

Fig.1 Transmitter DC test circuit

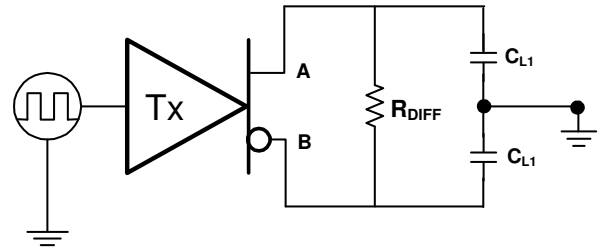

Fig.2 Transmitter timing test circuit

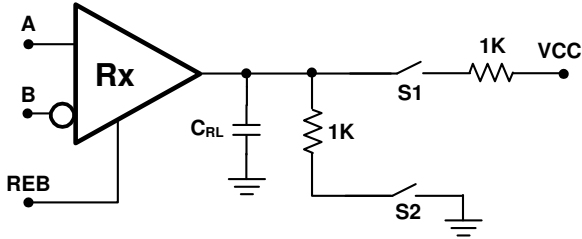

Fig.3 Receiver enable/disable timing test load

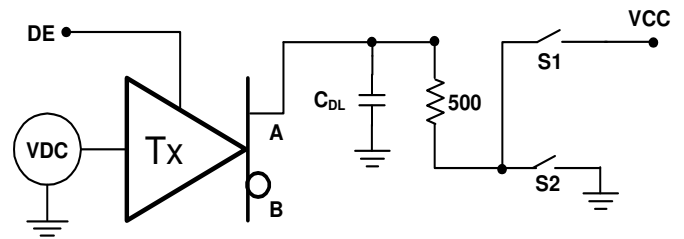

Fig.4 Transmitter enable/disable timing test load

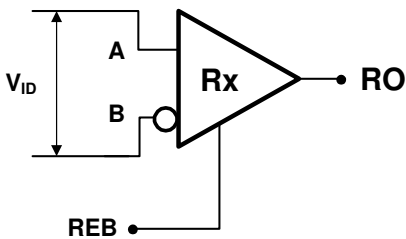

Fig.5 Receiver timing test circuit

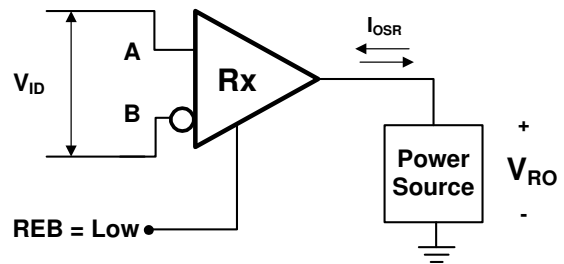

Fig.6 Receiver output short circuit

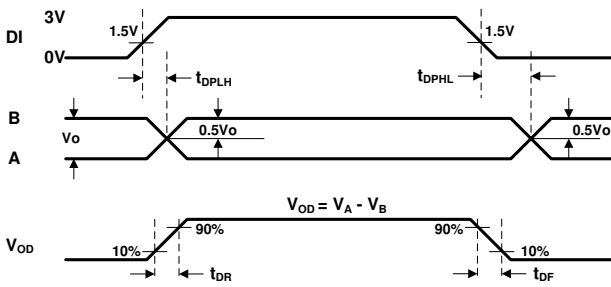

Fig.7 Transmitter Propagation Delays

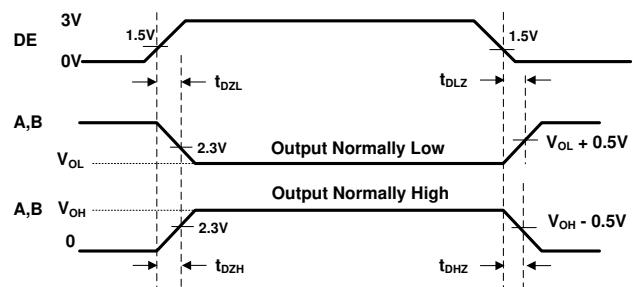

Fig.8 Transmitter Enable and Disable Times

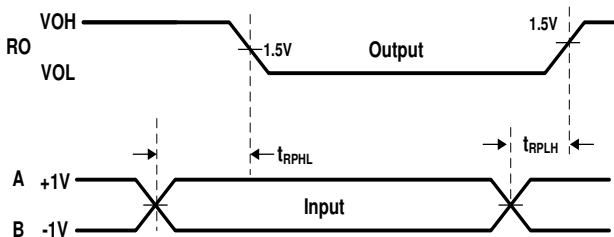

Fig.9 Receiver Propagation Delays

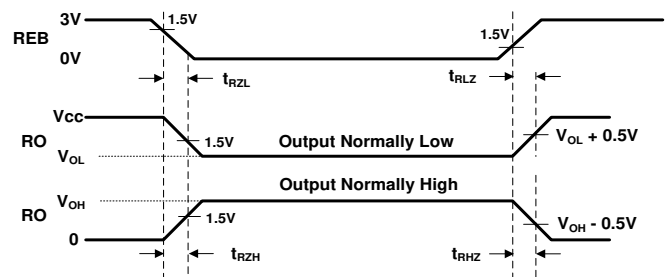
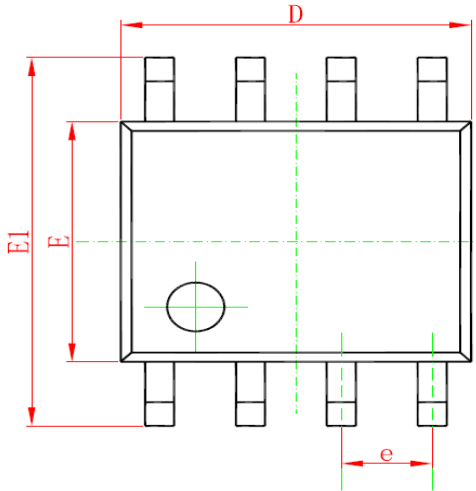

Fig.10 Receiver Enable and Disable Times



## Mechanical Details

**SOP-8**  
**PACKAGE DIAGRAMS**  
**TOP VIEW**



**SIDE VIEW**

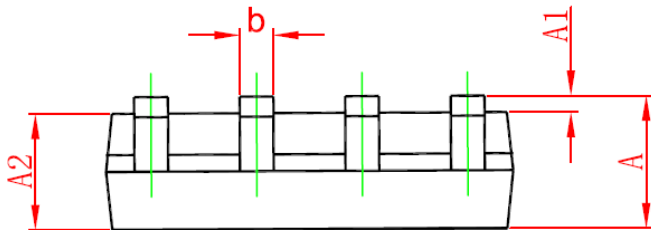

**END VIEW**

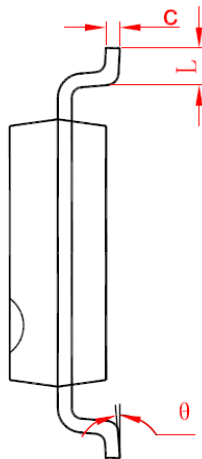

**PACKAGE DIMENSIONS**

Symbol	Millimeters		Inches	
	min	max	min	max
A	1.35	1.75	0.053	0.069
A1	0.10	0.25	0.004	0.010
A2	1.35	1.55	0.053	0.061
b	0.33	0.51	0.013	0.020
C	0.17	0.26	0.007	0.010
D	4.70	5.10	0.185	0.201
E	3.70	4.10	0.146	0.161
E1	5.80	6.20	0.228	0.244
e	1.27 BSC		0.05BSC	
L	0.40	1.27	0.016	0.050
L1	0.95	1.15	0.037	0.045
θ	0	8	0	8

## MARKING CODE

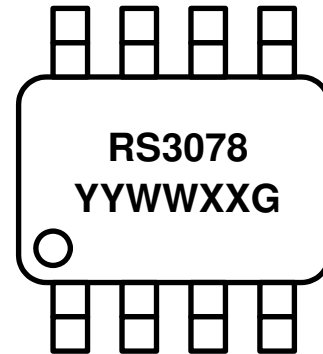

RS3078 = Device Code

YYWW = Date Code

XX = Control Code

G = Green Part Indication

Part Number	Marking Code
AZRS3078	RS3078 YYWWXXG





## Ordering Information

PN#	Material	Type	Reel size	MOQ/interal box	MOQ/carton
AZRS3078.RDG	Green	T/R	13 inch	1 reel=2,500/box	5 box=12,500/carton

## Revision History

Revision	Modification Description
Revision 2014/11/25	Formal Release.
Revision 2015/11/30	Added Order Information
Revision 2016/05/06	Modified the indication of Marking code.