

Features

- Typ $r_{DS(on)}$ = 173mΩ at $V_{GS} = 10V$, $I_D = 20A$
- Typ $Q_g(tot)$ = 72nC at $V_{GS} = 10V$, $I_D = 20A$
- UIS Capability
- RoHS Compliant
- Qualified to AEC Q101

Description

SuperFET™ is Fairchild's proprietary new generation of high voltage MOSFETs utilizing an advanced charge balance mechanism for outstanding low on-resistance and lower gate charge performance.

This advanced technology has been tailored to minimize conduction loss, provide superior switching performance, and withstand extreme dv/dt rate and higher avalanche energy.

Consequently, SuperFET is suitable for various automotive DC/DC power conversion.

Applications

- Automotive On Board Charger
- Automotive DC/DC converter for HEV

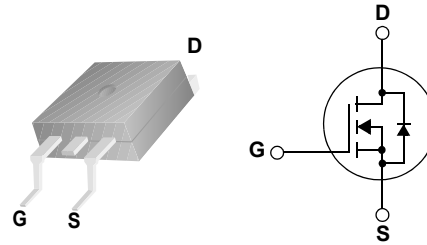

For current package drawing, please refer to the Fairchild website at www.fairchildsemi.com/packaging



MOSFET Maximum Ratings $T_J = 25^\circ\text{C}$ unless otherwise noted

Symbol	Parameter	Rated	Units
V_{DSS}	Drain to Source Voltage	600	V
V_{GS}	Gate to Source Voltage	±30	V
I_D	Drain Current - Continuous ($V_{GS}=10$) (Note 1)	$T_C = 25^\circ\text{C}$	20
	Pulsed Drain Current	$T_C = 25^\circ\text{C}$	See Figure4
E_{AS}	Single Pulse Avalanche Energy (Note 2)	480	mJ
P_D	Power Dissipation	341	W
	Derate above 25°C	2.3	W/ $^\circ\text{C}$
T_J, T_{STG}	Operating and Storage Temperature	-55 to + 150	$^\circ\text{C}$
$R_{\theta JC}$	Thermal Resistance Junction to Case	0.44	$^\circ\text{C/W}$
$R_{\theta JA}$	Maximum Thermal Resistance Junction to Ambient (Note 3)	43	$^\circ\text{C/W}$

Package Marking and Ordering Information

Device Marking	Device	Package	Reel Size	Tape Width	Quantity
FCB20N60	FCB20N60_F085	TO-263AB	330mm	24mm	800 units

Notes:

- 1: Current is limited by bondwire configuration.
- 2: Starting $T_J = 25^\circ\text{C}$, $L = 15\text{mH}$, $I_{AS} = 8A$, $V_{DD} = 100V$ during inductor charging and $V_{DD} = 0V$ during time in avalanche
- 3: $R_{\theta JA}$ is the sum of the junction-to-case and case-to-ambient thermal resistance where the case thermal reference is defined as the solder mounting surface of the drain pins. $R_{\theta JC}$ is guaranteed by design while $R_{\theta JA}$ is determined by the user's board design. The maximum rating presented here is based on mounting on a 1 in² pad of 2oz copper.

Electrical Characteristics $T_J = 25^\circ\text{C}$ unless otherwise noted

Symbol	Parameter	Test Conditions	Min	Typ	Max	Units
--------	-----------	-----------------	-----	-----	-----	-------

Off Characteristics

$B_{V_{DS}}$	Drain to Source Breakdown Voltage	$I_D = 250\mu\text{A}$, $V_{GS} = 0\text{V}$	600	-	-	V
I_{DSS}	Drain to Source Leakage Current	$V_{DS} = 600\text{V}$, $T_J = 25^\circ\text{C}$	-	-	1	μA
		$V_{GS} = 0\text{V}$, $T_J = 150^\circ\text{C}$ (Note 4)	-	-	1	mA
I_{GSS}	Gate to Source Leakage Current	$V_{GS} = \pm 30\text{V}$	-	-	± 100	nA

On Characteristics

$V_{GS(th)}$	Gate to Source Threshold Voltage	$V_{GS} = V_{DS}$, $I_D = 250\mu\text{A}$	3.0	4.0	5.0	V
$r_{DS(on)}$	Drain to Source On Resistance	$I_D = 20\text{A}$, $T_J = 25^\circ\text{C}$	-	173	198	$\text{m}\Omega$
		$V_{GS} = 10\text{V}$, $T_J = 150^\circ\text{C}$ (Note 4)	-	471	570	$\text{m}\Omega$

Dynamic Characteristics

C_{iss}	Input Capacitance	$V_{DS} = 25\text{V}$, $V_{GS} = 0\text{V}$, $f = 1\text{MHz}$	-	2710	3080	pF	
C_{oss}	Output Capacitance		-	1350	1665	pF	
C_{rss}	Reverse Transfer Capacitance		-	86	150	pF	
R_g	Gate Resistance	$f = 1\text{MHz}$	-	1	-	Ω	
$Q_{g(ToT)}$	Total Gate Charge at 10V	$V_{GS} = 0$ to 10V	$V_{DD} = 300\text{V}$ $I_D = 20\text{A}$	-	72	102	nC
$Q_{g(th)}$	Threshold Gate Charge	$V_{GS} = 0$ to 2V		-	5	8.6	nC
Q_{gs}	Gate to Source Gate Charge			-	15	-	nC
Q_{gd}	Gate to Drain "Miller" Charge		-	31	-	nC	

Switching Characteristics

t_{on}	Turn-On Time	$V_{DD} = 300\text{V}$, $I_D = 20\text{A}$, $V_{GS} = 10\text{V}$, $R_G = 25\Omega$	-	-	166	ns
$t_{d(on)}$	Turn-On Delay Time		-	44	-	ns
t_r	Rise Time		-	60	-	ns
$t_{d(off)}$	Turn-Off Delay Time		-	208	-	ns
t_f	Fall Time		-	43	-	ns
t_{off}	Turn-Off Time		-	-	400	ns

Drain-Source Diode Characteristics

V_{SD}	Source to Drain Diode Voltage	$I_{SD} = 20\text{A}$, $V_{GS} = 0\text{V}$	-	-	1.4	V
T_{rr}	Reverse Recovery Time	$I_F = 20\text{A}$, $dI_{SD}/dt = 100\text{A}/\mu\text{s}$	-	486	632	ns
Q_{rr}	Reverse Recovery Charge	$V_{DD} = 480\text{V}$	-	10	13	μC

Notes:

4: The maximum value is specified by design at $T_J = 150^\circ\text{C}$. Product is not tested to this condition in production.

Typical Characteristics

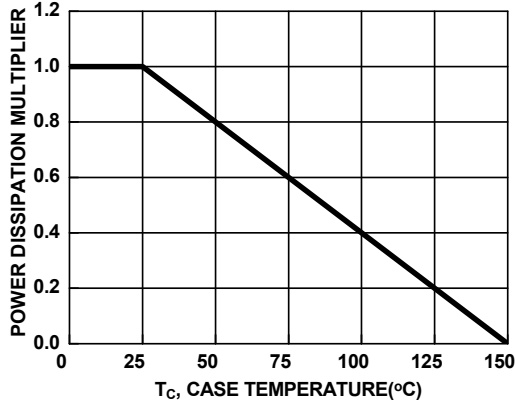

Figure 1. Normalized Power Dissipation vs Case Temperature

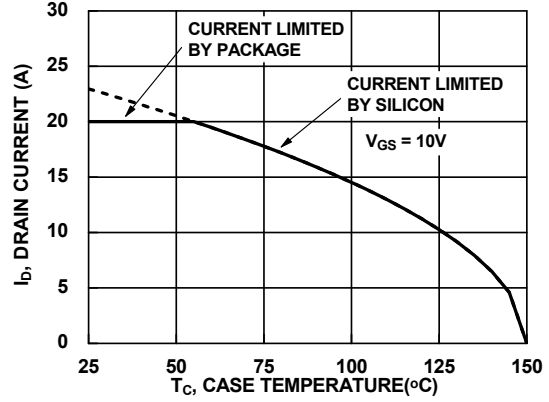

Figure 2. Maximum Continuous Drain Current vs Case Temperature

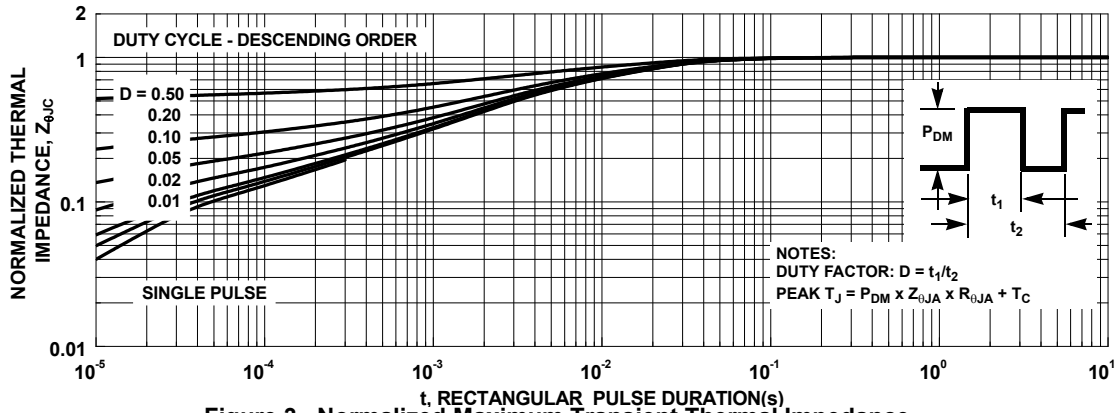

Figure 3. Normalized Maximum Transient Thermal Impedance

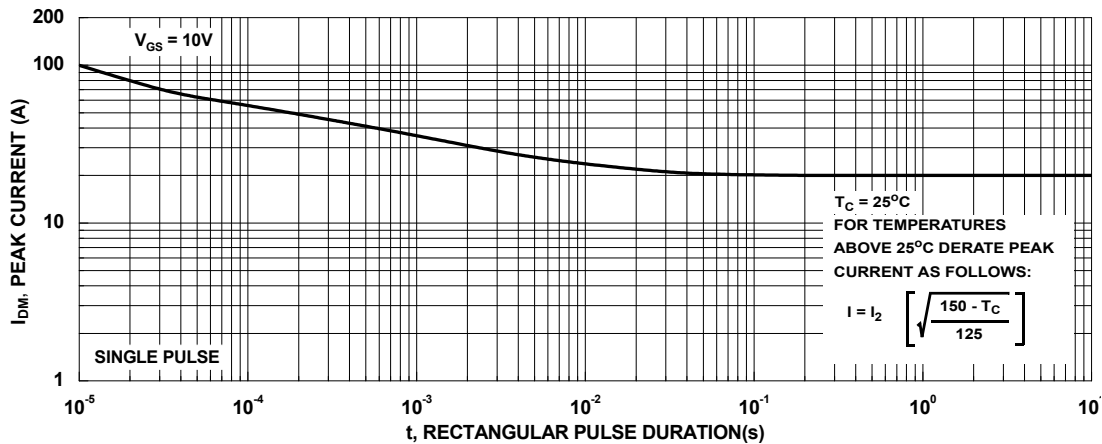

Figure 4. Peak Current Capability

Typical Characteristics

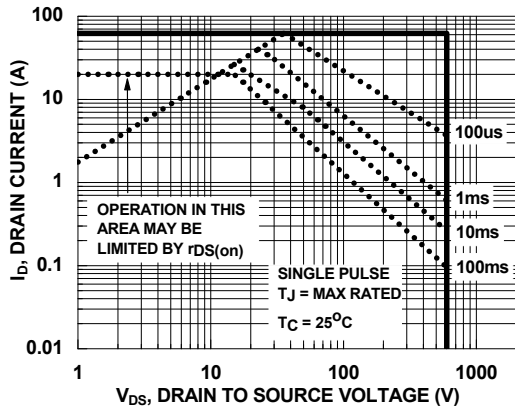

Figure 5. Forward Bias Safe Operating Area

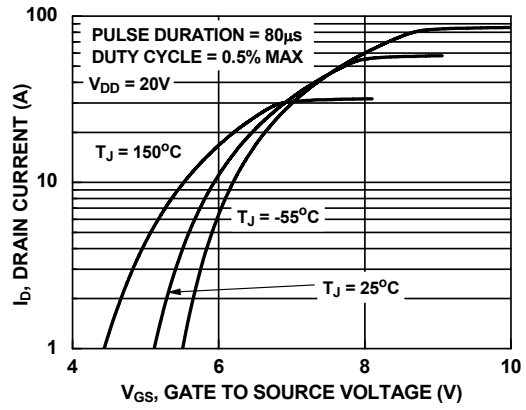

Figure 6. Transfer Characteristics

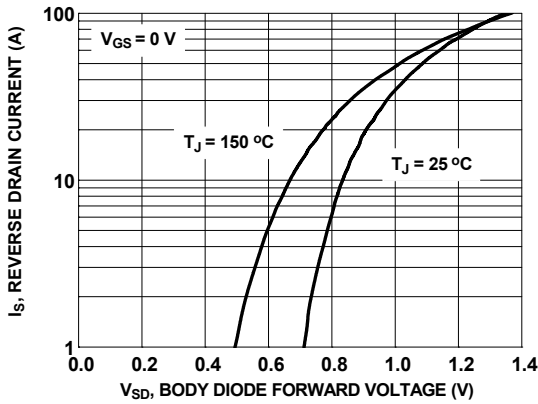

Figure 7. Forward Diode Characteristics

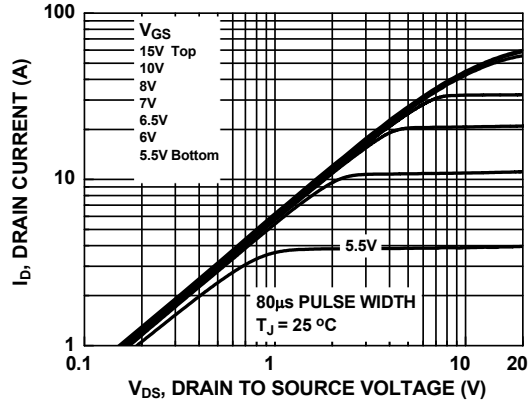

Figure 8. Saturation Characteristics

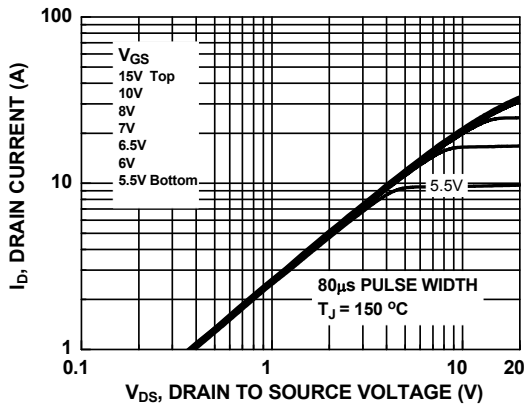

Figure 9. Saturation Characteristics

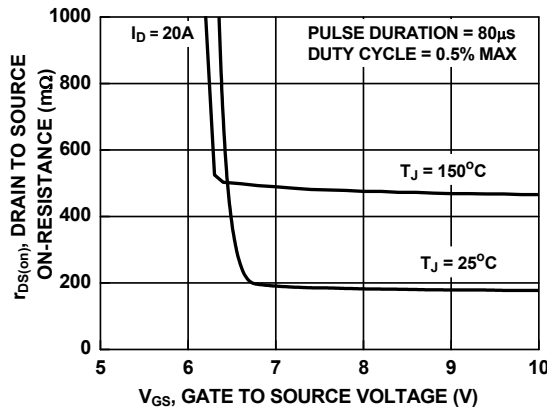

Figure 10. Rdson vs Gate Voltage

Typical Characteristics

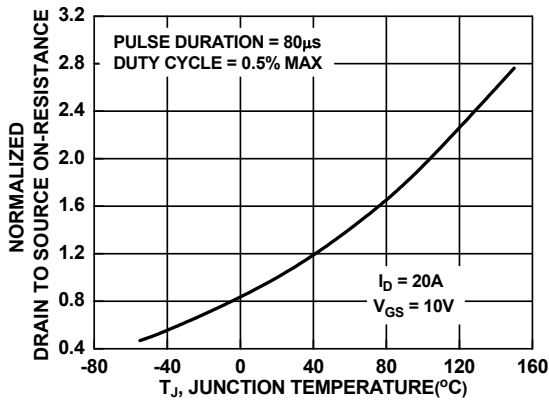

Figure 11. Normalized $R_{DS(on)}$ vs Junction Temperature

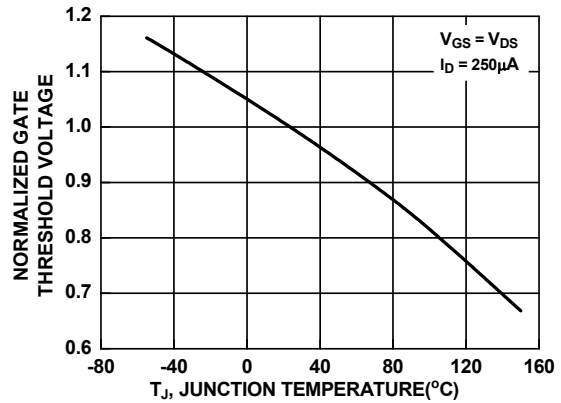

Figure 12. Normalized Gate Threshold Voltage vs Temperature

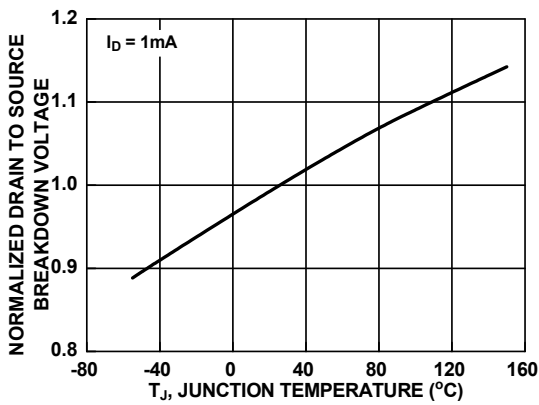

Figure 13. Normalized Drain to Source Breakdown Voltage vs Junction Temperature

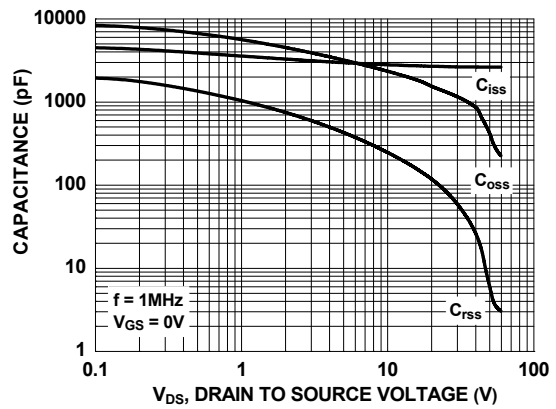

Figure 14. Capacitance vs Drain to Source Voltage

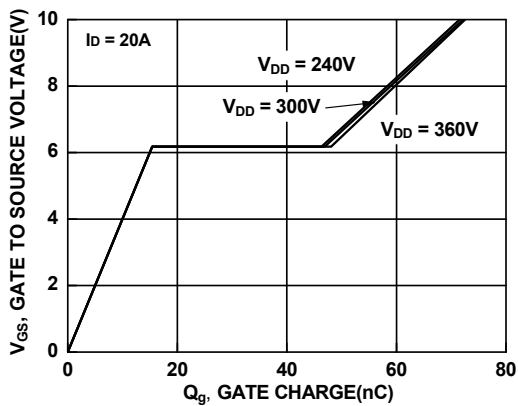



Figure 15. Gate Charge vs Gate to Source Voltage



TRADEMARKS

The following includes registered and unregistered trademarks and service marks, owned by Fairchild Semiconductor and/or its global subsidiaries, and is not intended to be an exhaustive list of all such trademarks.

- | | | | |
|---|---|---------------------------------------|---|
| AccuPower™ | F-PFS™ | PowerTrench® | Sync-Lock™ |
| AX-CAP®* | FRFET® | PowerXS™ | E SYSTEM ®* |
| BitSiC™ | Global Power ResourceSM | Programmable Active Droop™ | GENERAL |
| Build it Now™ | GreenBridge™ | QFET® | TinyBoost® |
| CorePLUS™ | Green FPS™ | QS™ | TinyBuck® |
| CorePOWER™ | Green FPS™ e-Series™ | Quiet Series™ | TinyCalc™ |
| CROSSVOLT™ | Gmax™ | RapidConfigure™ | TinyLogic® |
| CTL™ | GTO™ | Saving our world, 1mW/W/kW at a time™ | TINYOPTO™ |
| Current Transfer Logic™ | IntelliMAX™ | SignalWise™ | TinyPower™ |
| DEUXPEED® | ISOPLANAR™ | SmartMax™ | TinyPWM™ |
| Dual Cool™ | Marking Small Speakers Sound Louder and Better™ | SMART START™ | TinyWire™ |
| EcoSPARK® | MegaBuck™ | Solutions for Your Success™ | TranSiC™ |
| EfficientMax™ | MICROCOUPLER™ | SPM® | TriFault Detect™ |
| ESBC™ | MicroFET™ | STEALTH™ | TRUECURRENT®* |
|  | MicroPak™ | SuperFET® | µSerDes™ |
| Fairchild® | MicroPak2™ | SuperSOT™-3 |  |
| Fairchild Semiconductor® | MillerDrive™ | SuperSOT™-6 | UHC® |
| FACT Quiet Series™ | MotionMax™ | SuperSOT™-8 | Ultra FRFET™ |
| FACT® | mWSave® | SupreMOS® | UniFET™ |
| FAST® | OptoHiT™ | SyncFET™ | VCX™ |
| FastvCore™ | OPTOLOGIC® | | VisualMax™ |
| FETBench™ | OPTOPLANAR® | | VoltagePlus™ |
| FPS™ | | | XS™ |

*Trademarks of System General Corporation, used under license by Fairchild Semiconductor.

DISCLAIMER

FAIRCHILD SEMICONDUCTOR RESERVES THE RIGHT TO MAKE CHANGES WITHOUT FURTHER NOTICE TO ANY PRODUCTS HEREIN TO IMPROVE RELIABILITY, FUNCTION, OR DESIGN. FAIRCHILD DOES NOT ASSUME ANY LIABILITY ARISING OUT OF THE APPLICATION OR USE OF ANY PRODUCT OR CIRCUIT DESCRIBED HEREIN; NEITHER DOES IT CONVEY ANY LICENSE UNDER ITS PATENT RIGHTS, NOR THE RIGHTS OF OTHERS. THESE SPECIFICATIONS DO NOT EXPAND THE TERMS OF FAIRCHILD'S WORLDWIDE TERMS AND CONDITIONS, SPECIFICALLY THE WARRANTY THEREIN, WHICH COVERS THESE PRODUCTS.

LIFE SUPPORT POLICY

FAIRCHILD'S PRODUCTS ARE NOT AUTHORIZED FOR USE AS CRITICAL COMPONENTS IN LIFE SUPPORT DEVICES OR SYSTEMS WITHOUT THE EXPRESS WRITTEN APPROVAL OF FAIRCHILD SEMICONDUCTOR CORPORATION.

As used here in:

- Life support devices or systems are devices or systems which, (a) are intended for surgical implant into the body or (b) support or sustain life, and (c) whose failure to perform when properly used in accordance with instructions for use provided in the labeling, can be reasonably expected to result in a significant injury of the user.
- A critical component in any component of a life support, device, or system whose failure to perform can be reasonably expected to cause the failure of the life support device or system, or to affect its safety or effectiveness.

ANTI-COUNTERFEITING POLICY

Fairchild Semiconductor Corporation's Anti-Counterfeiting Policy. Fairchild's Anti-Counterfeiting Policy is also stated on our external website, www.Fairchildsemi.com, under Sales Support. Counterfeiting of semiconductor parts is a growing problem in the industry. All manufactures of semiconductor products are experiencing counterfeiting of their parts. Customers who inadvertently purchase counterfeit parts experience many problems such as loss of brand reputation, substandard performance, failed application, and increased cost of production and manufacturing delays. Fairchild is taking strong measures to protect ourselves and our customers from the proliferation of counterfeit parts. Fairchild strongly encourages customers to purchase Fairchild parts either directly from Fairchild or from Authorized Fairchild Distributors who are listed by country on our web page cited above. Products customers buy either from Fairchild directly or from Authorized Fairchild Distributors are genuine parts, have full traceability, meet Fairchild's quality standards for handling and storage and provide access to Fairchild's full range of up-to-date technical and product information. Fairchild and our Authorized Distributors will stand behind all warranties and will appropriately address and warranty issues that may arise. Fairchild will not provide any warranty coverage or other assistance for parts bought from Unauthorized Sources. Fairchild is committed to combat this global problem and encourage our customers to do their part in stopping this practice by buying direct or from authorized distributors.

PRODUCT STATUS DEFINITIONS

Definition of Terms

Datasheet Identification	Product Status	Definition
Advance Information	Formative / In Design	Datasheet contains the design specifications for product development. Specifications may change in any manner without notice.
Preliminary	First Production	Datasheet contains preliminary data; supplementary data will be published at a later date. Fairchild Semiconductor reserves the right to make changes at any time without notice to improve design.
No Identification Needed	Full Production	Datasheet contains final specifications. Fairchild Semiconductor reserves the right to make changes at any time without notice to improve the design.
Obsolete	Not In Production	Datasheet contains specifications on a product that is discontinued by Fairchild Semiconductor. The datasheet is for reference information only.

Rev. 166