



Cable Assemblies > Copper Cable Assemblies > M8/M12 Cable Assemblies > M8 Connector: Pigtail Cable, Straight, Male



M8/M12 Application Type: **Sensor/Actuator**

Number of Positions: **4**

Connector & Keying Code: **A**

Connector Type (End A): **M8 Plug**

Cable Assembly Type: **M8 Pigtail**

[All M8 Connector: Pigtail Cable, Straight, Male \(31\)](#)

Features

Product Type Features

Connector Type (End A)	M8 Plug
Cable Assembly Type	M8 Pigtail

Configuration Features

Number of Positions	4
---------------------	---

Electrical Characteristics

Operating Voltage	30 VAC
-------------------	--------

Body Features

Cable Color	Black
Connector Color (End A)	Black
Jacket Material	PUR
Wire Color (Base)	Brown, White, Blue, Black
Connector & Keying Code	A

Contact Features

Contact Current Rating (Max)	4 A
------------------------------	-----

Mechanical Attachment

Thread Size	M8
Connector Orientation (End A)	Straight



Housing Features

Housing Material	Plastic
------------------	---------

Dimensions

Outside Cable Diameter	5.3 mm [.208 in]
Wire Size	.326 mm ²

Usage Conditions

Operating Temperature Range	-40 – 80 °C [-40 – 176 °F]
-----------------------------	----------------------------

Operation/Application

M8/M12 Application Type	Sensor/Actuator
Shielded	Yes

Packaging Features

Packaging Quantity	25
Packaging Method	Box

Other

Field Serviceable	Yes
Cable Assembly Length	3 m
Cable Assembly Configuration	Single Ended

Product Compliance

[For compliance documentation, visit the product page on TE.com>](#)

EU RoHS Directive 2011/65/EU	Compliant
EU ELV Directive 2000/53/EC	Compliant
China RoHS 2 Directive MIIT Order No 32, 2016	No Restricted Materials Above Threshold
EU REACH Regulation (EC) No. 1907/2006	Current ECHA Candidate List: JUNE 2023 (235) Candidate List Declared Against: JUL 2021 (219) Does not contain REACH SVHC
Halogen Content	Low Halogen - Br, Cl, F, I < 900 ppm per homogenous material. Also BFR/CFR/PVC Free
Solder Process Capability	Not applicable for solder process capability

Product Compliance Disclaimer

This information is provided based on reasonable inquiry of our suppliers and represents our current actual knowledge based on the information they provided. This information is subject to change. The part numbers that TE has identified as EU RoHS compliant have a maximum concentration of 0.1% by weight in homogenous materials for lead, hexavalent chromium, mercury, PBB, PBDE, DBP, BBP, DEHP, DIBP, and 0.01% for cadmium, or qualify for an exemption to these limits as defined in the Annexes of Directive 2011/65/EU (RoHS2). Finished electrical and electronic equipment products will be CE marked as required by Directive 2011/65/EU. Components may not be CE marked. Additionally, the part numbers that TE has identified as EU ELV compliant have a maximum concentration of 0.1% by weight in homogenous materials for lead, hexavalent chromium, and mercury, and 0.01% for cadmium, or qualify for an exemption to these limits as defined in the Annexes of Directive 2000/53/EC (ELV). Regarding the REACH Regulation, the information TE provides on SVHC in articles for this part number is based on the latest European Chemicals Agency (ECHA) 'Guidance on requirements for substances in articles' posted at this URL: <https://echa.europa.eu/guidance-documents/guidance-on-reach>

Compatible Parts



Customers Also Bought

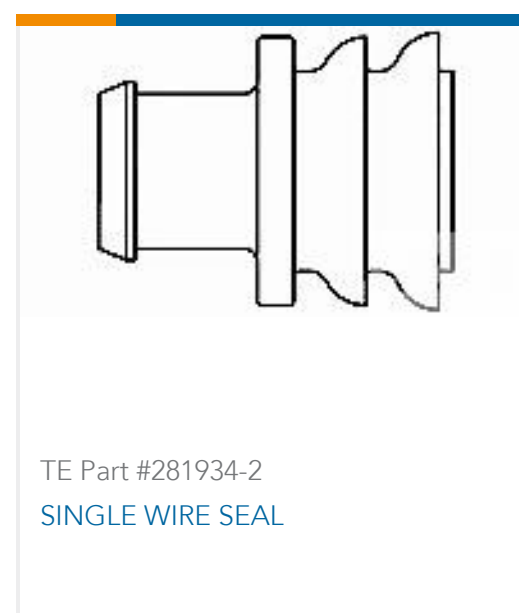

Documents

Product Drawings

M8 x 1.0 straight plug Pigtail Shld

English

CAD Files

3D PDF



3D

Customer View Model

[ENG_CVM_CVM_2273006-2_A.2d_dxf.zip](#)

English

Customer View Model

[ENG_CVM_CVM_2273006-2_A.3d_igs.zip](#)

English

Customer View Model

[ENG_CVM_CVM_2273006-2_A.3d_stp.zip](#)

English

By downloading the CAD file I accept and agree to the [Terms and Conditions](#) of use.

Datasheets & Catalog Pages

[M8 / M12 Connector System Catalog](#)

English

[M8 / M12 Connector System Catalog](#)

Japanese

Product Specifications

[Product Specification](#)

English