

Features

- $BV_{CEO} > -100V$
- $I_C = -3A$ Continuous Collector Current
- $I_{CM} = -8A$ Peak Pulse Current
- $R_{CE(sat)} = 110m\Omega$ (Typ)
- Rated to $+175^\circ C$ – Ideal for High Ambient Temperature Environments
- Complementary Part: DXTN3C100PDQ
- **Totally Lead-Free & Fully RoHS Compliant (Notes 1 & 2)**
- **Halogen and Antimony Free. “Green” Device (Note 3)**
- **The DXTP3C100PDQ is suitable for automotive applications requiring specific change control; this part is AEC-Q101 qualified, PPAP capable, and manufactured in IATF16949 certified facilities.**

<https://www.diodes.com/quality/product-definitions/>

Mechanical Data

- Package: PowerDI5060-8/SWP (Type UXD)
- Package Material: Molded Plastic, “Green” Molding Compound. UL Flammability Classification Rating 94V-0
- Moisture Sensitivity: Level 1 per J-STD-020
- Terminal Finish - Matte Tin Annealed over Copper Lead-Frame; Solderable per MIL-STD-202, Method 208
- Weight: 0.097 grams (Approximate)

Applications

- Power Management
- Load Switches

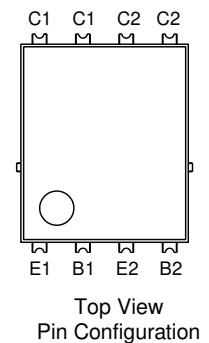
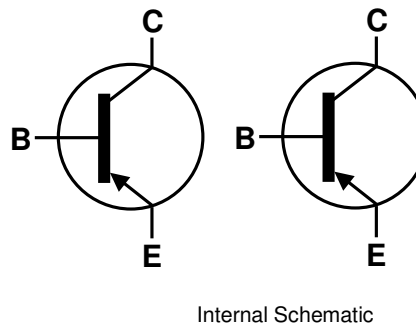
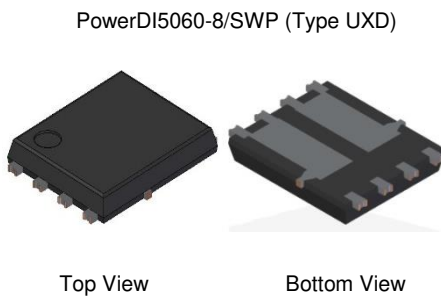

Ordering Information

Product	Compliant	Marking	Reel Size (inches)	Tape Width (mm)	Quantity per reel
DXTP3C100PDQ-13	Automotive	DXTP3C100PD	13	12	1,000

- Notes:
1. No purposely added lead. Fully EU Directive 2002/95/EC (RoHS), 2011/65/EU (RoHS 2) & 2015/863/EU (RoHS 3) compliant.
 2. See <https://www.diodes.com/quality/lead-free/> for more information about Diodes Incorporated’s definitions of Halogen- and Antimony-free, “Green” and Lead-free.
 3. Halogen- and Antimony-free “Green” products are defined as those which contain <900ppm bromine, <900ppm chlorine (<1500ppm total Br + Cl) and <1000ppm antimony compounds.
 4. For packaging details, go to our website at <https://www.diodes.com/design/support/packaging/diodes-packaging/>.

Marking Information

PowerDI5060-8/SWP (Type UXD)

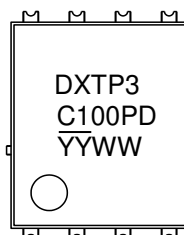

DXTP3 = Product Type Marking Code
 C100PD = Product Type Marking Code
 YYWW = Date Code Marking
 YY = Last Digit of Year (ex: 21 = 2021)
 WW = Week Code (01 to 53)

Absolute Maximum Ratings (@ $T_A = +25^\circ\text{C}$, unless otherwise specified.)

Characteristic	Symbol	Value	Unit
Collector-Base Voltage	V_{CBO}	-100	V
Collector-Emitter Voltage	V_{CEO}	-100	V
Emitter-Base Voltage	V_{EBO}	-7	V
Base Current	I_B	-0.5	A
Continuous Collector Current	I_C	-3	A
Peak Pulse Collector Current	I_{CM}	-8	A

Thermal Characteristics (@ $T_A = +25^\circ\text{C}$, unless otherwise specified.)

Characteristic	Symbol	Value	Unit
Power Dissipation	P_D	1.76	W
Linear Derating Factor		11.7	
Thermal Resistance, Junction to Ambient	$R_{\theta JA}$	85	$^\circ\text{C/W}$
		37	
Thermal Resistance, Junction to Lead	$R_{\theta JL}$	5.7	$^\circ\text{C/W}$
Operating and Storage Temperature Range	T_J, T_{STG}	-55 to +175	$^\circ\text{C}$

ESD Ratings (Note 9)

Characteristic	Symbol	Value	Unit	JEDEC Class
Electrostatic Discharge - Human Body Model	ESD HBM	4000	V	3A
Electrostatic Discharge – Charged Device Model	ESD CDM	1000	V	C3

- Notes:
5. For a device mounted with the collector lead on 25mm x 25mm 1oz copper that is on single-sided 1.6mm FR4 PCB; device with one active die is measured under still air conditions whilst operating in a steady-state.
 6. Same as Note 5, except the device is measured at $t \leq 5$ sec.
 7. For a dual device with one active die.
 8. Thermal resistance from junction to solder-point (at the end of the collector lead).
 9. Refer to JEDEC specification JESD22-A114 and JESD22-A115.

Thermal Characteristics and Derating Information

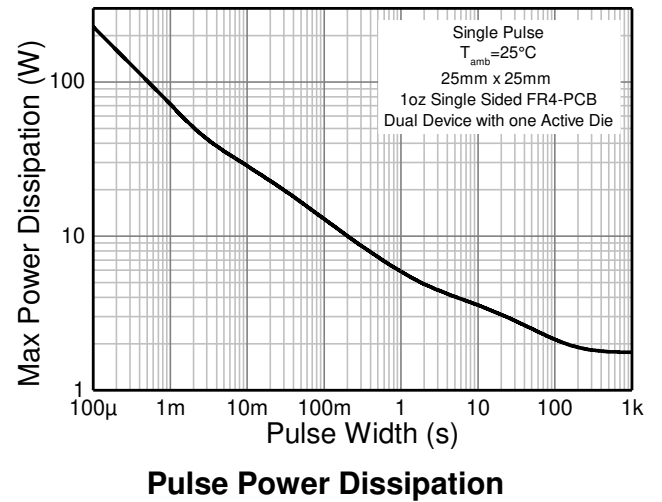
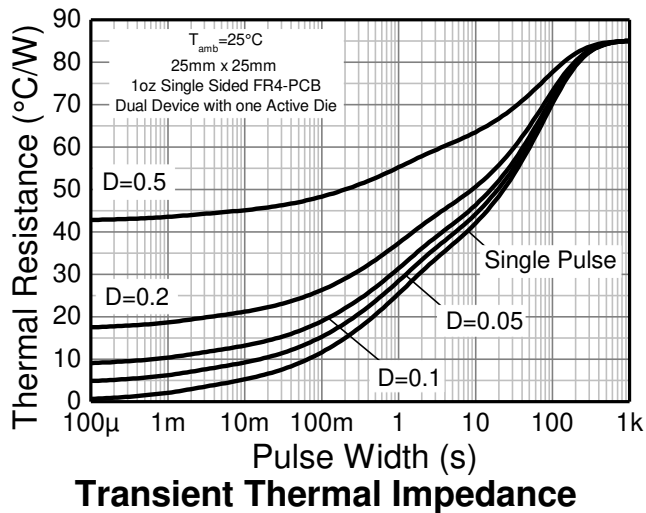
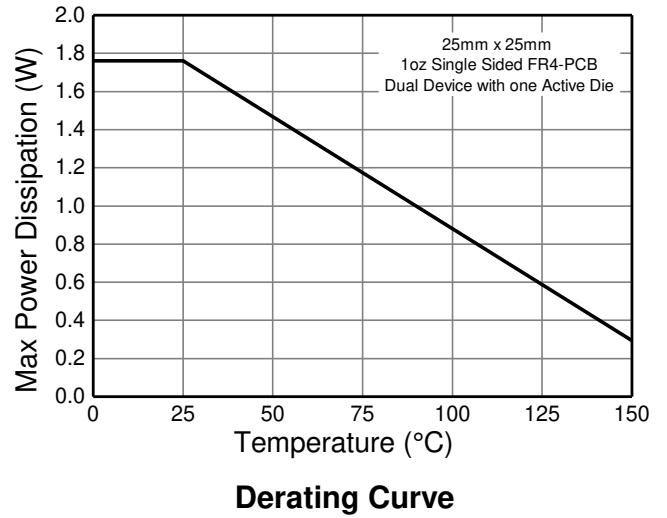
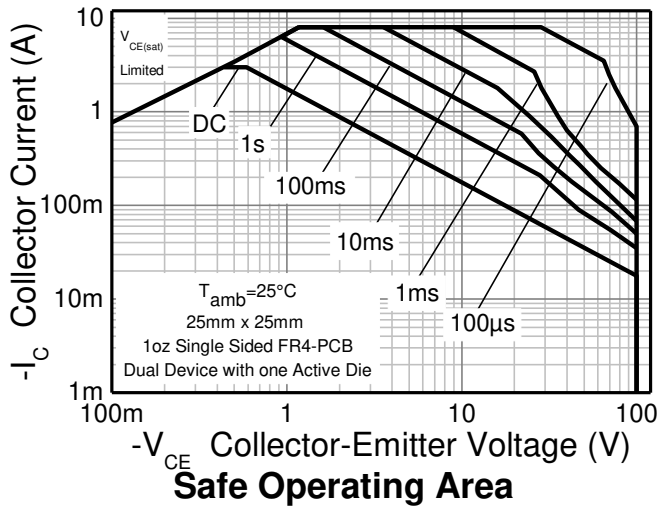

Electrical Characteristics (@ T_A = +25°C, unless otherwise specified.)

Characteristic	Symbol	Min	Typ	Max	Unit	Test Condition
OFF CHARACTERISTICS						
Collector-Base Breakdown Voltage	BV _{CBO}	-100	—	—	V	I _C = -100μA
Collector-Emitter Breakdown Voltage (Note10)	BV _{CEO}	-100	—	—	V	I _C = -10mA
Emitter-Base Breakdown Voltage	BV _{EBO}	-7	—	—	V	I _E = -100μA
Collector-Base Cutoff Current	I _{CBO}	—	—	-100	nA	V _{CB} = -80V
		—	—	-50	μA	V _{CB} = -80V @T _J = 150°C
Emitter Cutoff Current	I _{EBO}	—	—	-100	nA	V _{EB} = -7V
Collector-Emitter Cutoff Current	I _{CES}	—	—	-100	nA	V _{CES} = -80V
ON CHARACTERISTICS (Note10)						
DC Current Gain	h _{FE}	170	305	—	—	I _C = -500mA, V _{CE} = -10V
		160	275	—		I _C = -1A, V _{CE} = -10V
		45	90	—		I _C = -2A, V _{CE} = -10V
		10	20	—		I _C = -3A, V _{CE} = -10V
Collector-Emitter Saturation Voltage	V _{CE(sat)}	—	-70	-110	mV	I _C = -0.5A, I _B = -50mA
		—	-220	-325		I _C = -2A, I _B = -200mA
Collector-Emitter Saturation Resistance	R _{CE(sat)}	—	110	180	mΩ	I _C = -2A, I _B = -200mA
Base-Emitter Saturation Voltage	V _{BE(sat)}	—	-0.91	-1	V	I _C = -1A, I _B = -50mA
		—	-1.02	-1.2		I _C = -2A, I _B = -200mA
Base-Emitter Turn-On Voltage	V _{BE(on)}	—	-0.68	-0.9	V	I _C = -0.1A, V _{CE} = -2V
SMALL SIGNAL CHARACTERISTICS						
Current Gain-Bandwidth Product	f _T	—	100	—	MHz	V _{CE} = -10V, I _C = -100mA, f = 100MHz
Output Capacitance	C _{obo}	—	30	—	pF	V _{CB} = -10V, f = -1MHz
Delay Time	t _d	—	30	—	ns	V _{CC} = -12.5V, I _C = -1A I _{B1} = -I _{B2} = -50mA
Rise Time	t _r	—	30	—	ns	
Turn-On Time	t _{on}	—	60	—	ns	
Storage Time	t _s	—	660	—	ns	
Fall Time	t _f	—	50	—	ns	
Turn-Off Time	t _{off}	—	710	—	ns	

Note: 10. Measured under pulsed conditions. Pulse width ≤ 300μs. Duty cycle ≤ 2%.

Typical Electrical Characteristics (@ $T_A = +25^\circ\text{C}$, unless otherwise specified.)

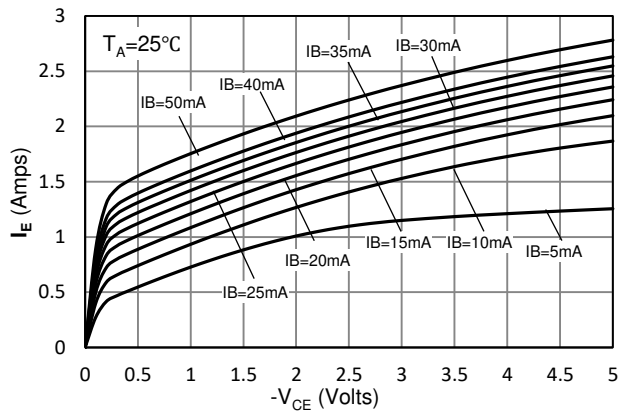

V_{CE} vs I_E

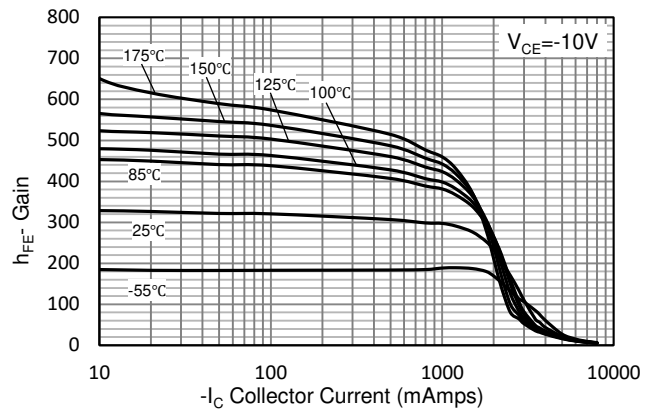

h_{FE} vs I_C

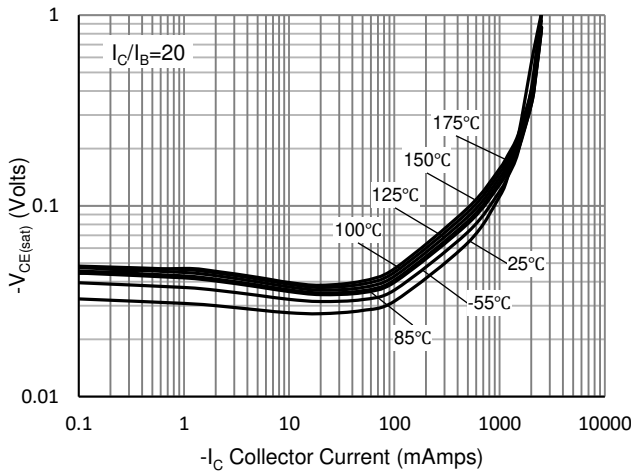

$V_{CE(sat)}$ vs I_C

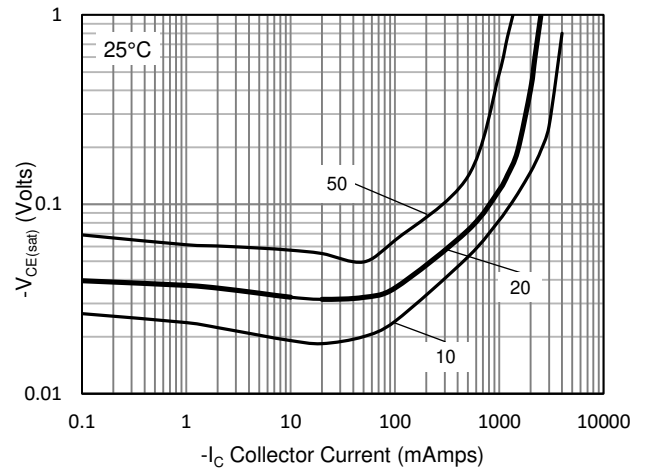

$V_{CE(sat)}$ vs I_C

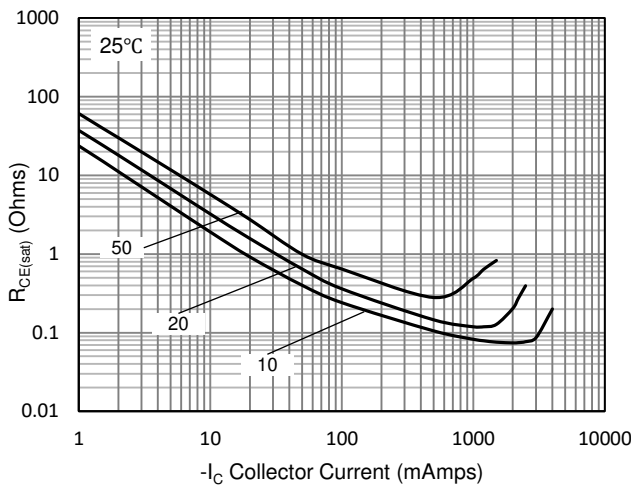

$R_{CE(sat)}$ vs I_C

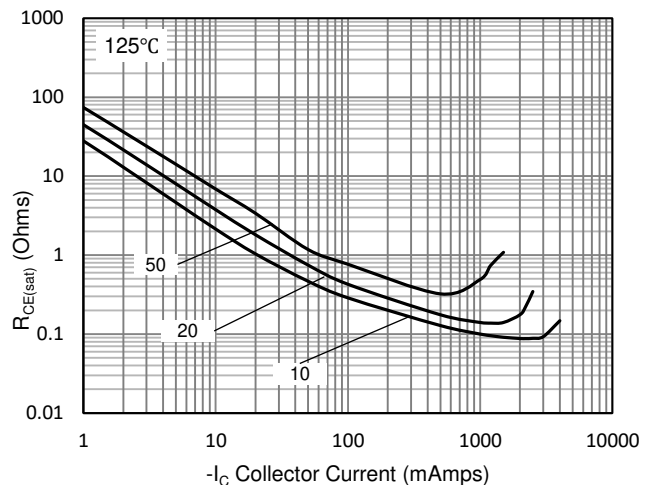

$R_{CE(sat)}$ vs I_C

Typical Electrical Characteristics (@ $T_A = +25^\circ\text{C}$, unless otherwise specified.)

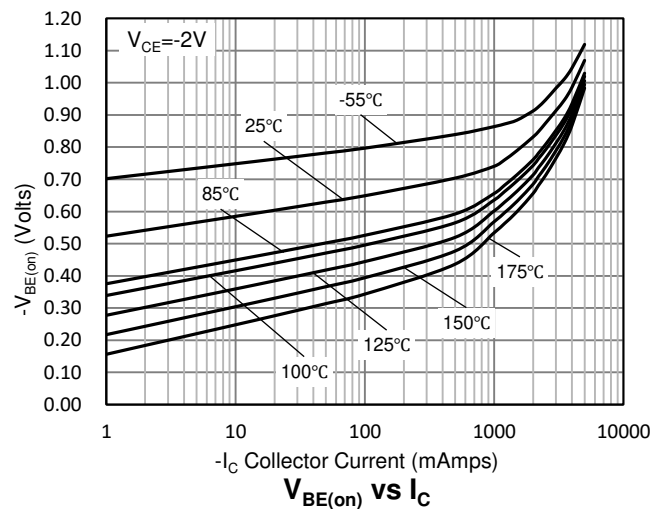
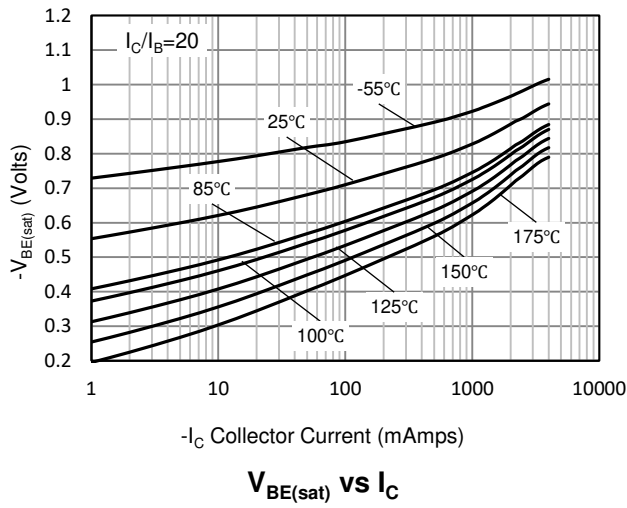

Package Outline Dimensions

Please see <http://www.diodes.com/package-outlines.html> for the latest version.

PowerDI5060-8/SWP (Type UXD)

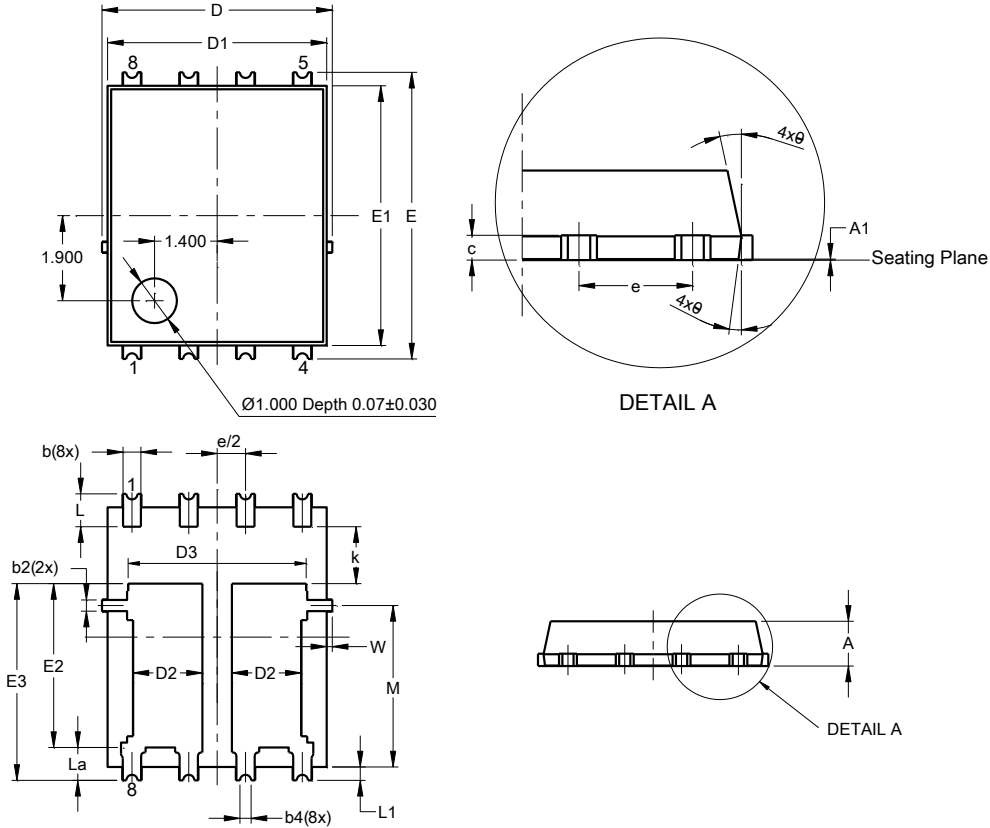

PowerDI5060-8/SWP (Type UXD)			
Dim	Min	Max	Typ
A	0.90	1.10	1.00
A1	0.00	0.05	--
b	0.30	0.50	0.41
b2	0.20	0.35	0.25
b4	0.25REF		
c	0.230	0.330	0.277
D	5.15 BSC		
D1	4.70	5.10	4.90
D2	1.46	1.66	1.55
D3	3.78	4.18	3.98
E	6.40 BSC		
E1	5.60	6.00	5.80
E2	3.46	3.86	3.66
E2a	4.195	4.595	4.395
e	1.27BSC		
k	1.05	--	--
L	0.635	0.835	0.735
La	0.635	0.835	0.735
L1	0.200	0.400	0.300
M	3.205	4.005	3.605
W	0.025	0.225	0.125
θ	10°	12°	11°
θ1	6°	8°	7°
All Dimensions in mm			

Suggested Pad Layout

Please see <http://www.diodes.com/package-outlines.html> for the latest version.

PowerDI5060-8/SWP (Type UXD)

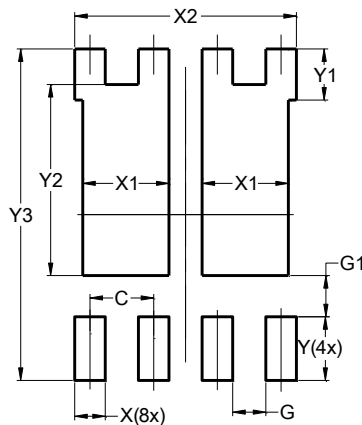

Dimensions	Value (in mm)
C	1.270
G	0.660
G1	0.820
X	0.610
X1	1.720
X2	4.420
Y	1.270
Y1	1.020
Y2	3.810
Y3	6.610

IMPORTANT NOTICE

1. DIODES INCORPORATED AND ITS SUBSIDIARIES (“DIODES”) MAKE NO WARRANTY OF ANY KIND, EXPRESS OR IMPLIED, WITH REGARDS TO ANY INFORMATION CONTAINED IN THIS DOCUMENT, INCLUDING, BUT NOT LIMITED TO, THE IMPLIED WARRANTIES OF MERCHANTABILITY, FITNESS FOR A PARTICULAR PURPOSE OR NON-INFRINGEMENT OF THIRD PARTY INTELLECTUAL PROPERTY RIGHTS (AND THEIR EQUIVALENTS UNDER THE LAWS OF ANY JURISDICTION).
2. The Information contained herein is for informational purpose only and is provided only to illustrate the operation of Diodes products described herein and application examples. Diodes does not assume any liability arising out of the application or use of this document or any product described herein. This document is intended for skilled and technically trained engineering customers and users who design with Diodes products. Diodes products may be used to facilitate safety-related applications; however, in all instances customers and users are responsible for (a) selecting the appropriate Diodes products for their applications, (b) evaluating the suitability of the Diodes products for their intended applications, (c) ensuring their applications, which incorporate Diodes products, comply the applicable legal and regulatory requirements as well as safety and functional-safety related standards, and (d) ensuring they design with appropriate safeguards (including testing, validation, quality control techniques, redundancy, malfunction prevention, and appropriate treatment for aging degradation) to minimize the risks associated with their applications.
3. Diodes assumes no liability for any application-related information, support, assistance or feedback that may be provided by Diodes from time to time. Any customer or user of this document or products described herein will assume all risks and liabilities associated with such use, and will hold Diodes and all companies whose products are represented herein or on Diodes’ websites, harmless against all damages and liabilities.
4. Products described herein may be covered by one or more United States, international or foreign patents and pending patent applications. Product names and markings noted herein may also be covered by one or more United States, international or foreign trademarks and trademark applications. Diodes does not convey any license under any of its intellectual property rights or the rights of any third parties (including third parties whose products and services may be described in this document or on Diodes’ website) under this document.
5. Diodes products are provided subject to Diodes’ Standard Terms and Conditions of Sale (<https://www.diodes.com/about/company/terms-and-conditions/terms-and-conditions-of-sales/>) or other applicable terms. This document does not alter or expand the applicable warranties provided by Diodes. Diodes does not warrant or accept any liability whatsoever in respect of any products purchased through unauthorized sales channel.
6. Diodes products and technology may not be used for or incorporated into any products or systems whose manufacture, use or sale is prohibited under any applicable laws and regulations. Should customers or users use Diodes products in contravention of any applicable laws or regulations, or for any unintended or unauthorized application, customers and users will (a) be solely responsible for any damages, losses or penalties arising in connection therewith or as a result thereof, and (b) indemnify and hold Diodes and its representatives and agents harmless against any and all claims, damages, expenses, and attorney fees arising out of, directly or indirectly, any claim relating to any noncompliance with the applicable laws and regulations, as well as any unintended or unauthorized application.
7. While efforts have been made to ensure the information contained in this document is accurate, complete and current, it may contain technical inaccuracies, omissions and typographical errors. Diodes does not warrant that information contained in this document is error-free and Diodes is under no obligation to update or otherwise correct this information. Notwithstanding the foregoing, Diodes reserves the right to make modifications, enhancements, improvements, corrections or other changes without further notice to this document and any product described herein. This document is written in English but may be translated into multiple languages for reference. Only the English version of this document is the final and determinative format released by Diodes.
8. Any unauthorized copying, modification, distribution, transmission, display or other use of this document (or any portion hereof) is prohibited. Diodes assumes no responsibility for any losses incurred by the customers or users or any third parties arising from any such unauthorized use.

Copyright © 2021 Diodes Incorporated

www.diodes.com