

QT-Brightek Chip LED Series

SMD 1210 RGB LED

Part No.: QBLP650-RGB

Product: QBLP600-RGB	Date: September 08, 2015	Page 1 of 10
	Version# 2.2	

Table of Contents:

Introduction	3
Electrical / Optical Characteristic (T=25 °C)	4
Absolute Maximum Rating	4
Characteristic Curves.....	6
Solder Profile & Footprint.....	7
Packing	8
Labeling	9
Ordering Information	9
Revision History	10
Disclaimer	10

Introduction

Feature:

- Water clear lens
- Package in tape and reel
- Ultra bright 1210 LED package
- Common Anode
- InGaN technology for IB/IG
- AlInGaP technology for R

Description:

These ultra bright 1210 RGB LEDs have a height profile of 0.80mm. Combination of high brightness output and small footprint, these LEDs are ideal for keypad backlighting, status indication, and color mixing applications.

Application:

- Status indication
- Back lighting application

Certification & Compliance:

- TS16949
- ISO9001
- RoHS Compliant

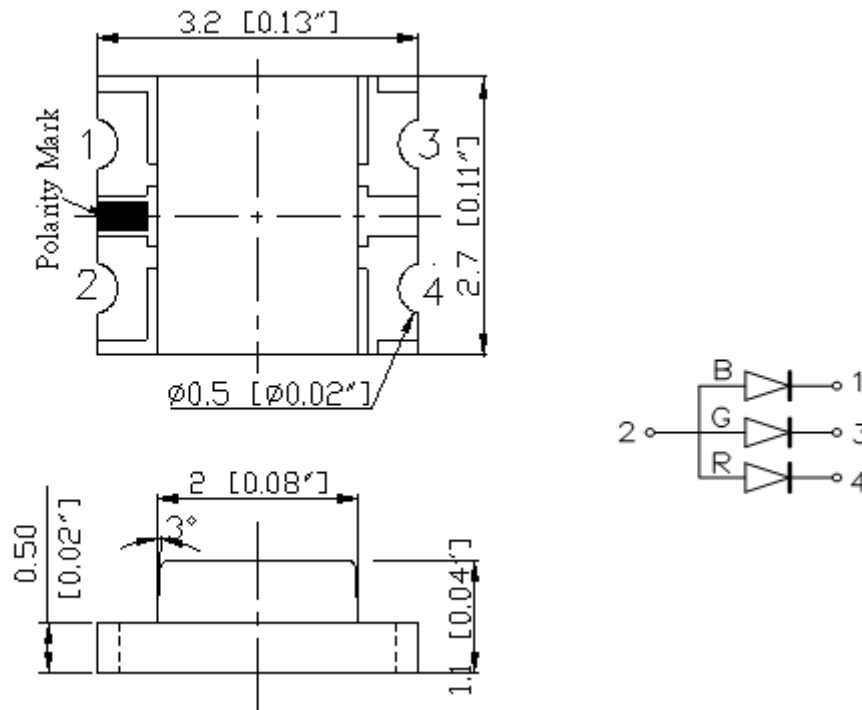
**Dimension:**

Units: mm / tolerance = +/-0.1mm

Electrical / Optical Characteristic (T=25 °C)

Product	Color	I _F (mA)	V _F (V)		λ _D (nm)			I _V (mcd)	
			Typ.	Max.	Min.	Typ.	Max.	Min.	Typ.
QBLP650-RGB	Red	20	2.0	2.5	615	620	630	80	140
	True Green	20	3.4	3.7	520	525	530	320	500
	Blue	20	3.1	3.7	465	470	475	40	100

Absolute Maximum Rating

Material	P _d (mW)	I _F (mA)	I _{FP} (mA)*	V _R (V)	T _{OP} (°C)	T _{ST} (°C)	T _{SO} L (°C)**
InGaN (IB/IG)	111	30	125	5	-40 ~ + 80	-40 ~ +85	260
AlInGaP (R)	75	30	125	5	-40 ~ + 80	-40 ~ +85	260

*Duty 1/8 @ 1KHz

** IR Reflow for no more than 10 sec @ 260 °C

Forward Voltage V_F for AlInGaP @ I_F=20mA

Bin	Min.	Max.	Unit
□	1.7	2.5	V

Forward Voltage V_F for InGaN @ I_F=20mA

Bin	Min.	Max.	Unit
f	2.8	3.1	V
g	3.1	3.4	
h	3.4	3.7	

Luminous Intensity I_V @ $I_F=20mA$

Bin	Min.	Max.	Unit
F	40	50	mcd
G	50	63	
H	63	80	
I	80	100	
J	100	125	
K	125	160	
L	160	200	
M	200	250	
N	250	320	
O	320	400	
P	400	500	
Q	500	630	
R	630	800	

Dominant Wavelength λ_D for Red @ $I_F=20mA$

Bin	Min.	Max.	Unit
s	615	620	nm
t	620	625	
u	625	630	

Dominant Wavelength λ_D for Green @ $I_F=20mA$

Bin	Min.	Max.	Unit
U	520	522.5	nm
V	522.5	525	
W	525	527.5	
X	527.5	530	

Dominant Wavelength λ_D for Blue @ $I_F=20mA$

Bin	Min.	Max.	Unit
G	465	467.5	nm
H	467.5	470	
I	470	472.5	
J	472.5	475	

Characteristic Curves

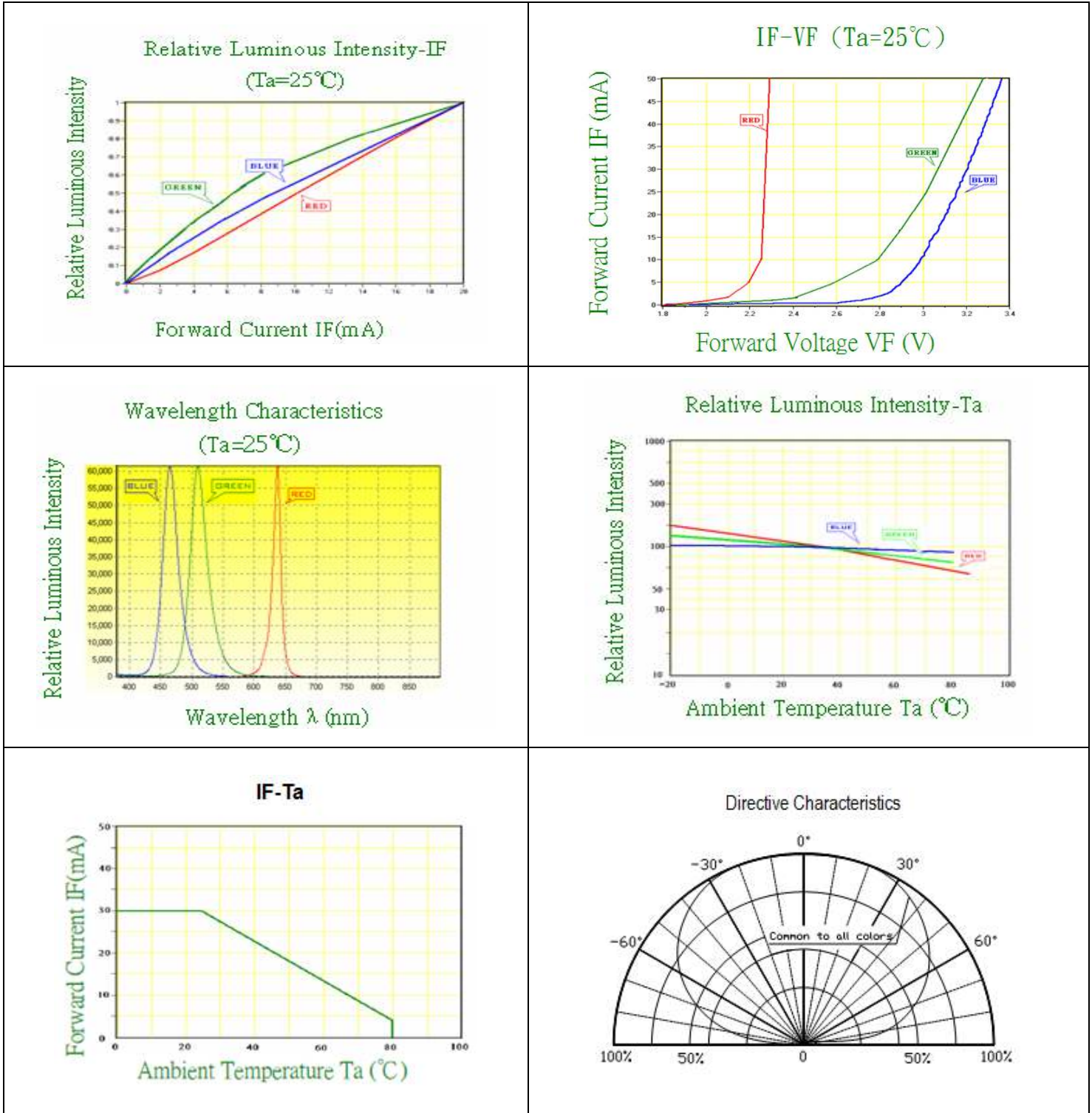

Solder Profile & Footprint

- Recommended tin solder specifications: melting temperature in the range of 178~192 °C
- The recommended reflow soldering profile is as follows (temperatures indicated are as measured on the surface of the LED resin):

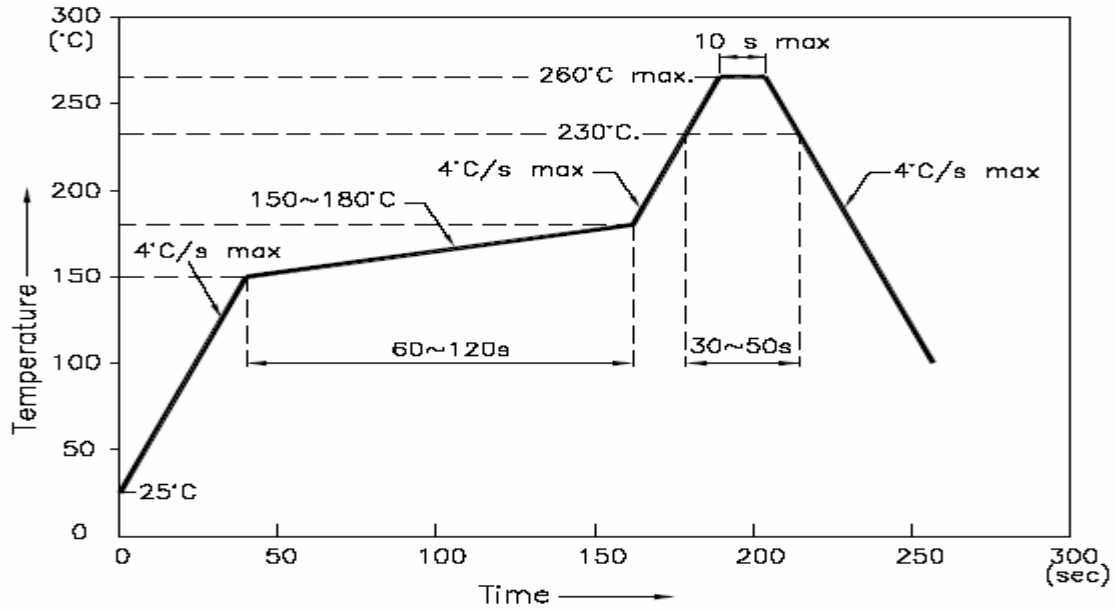

Recommended Pad Layout

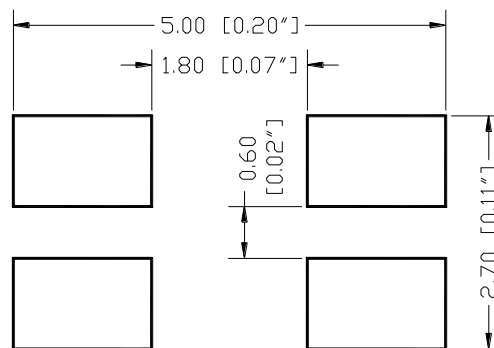

Units: mm

Tolerance: ± 0.1mm

Packing

Reel Dimension:

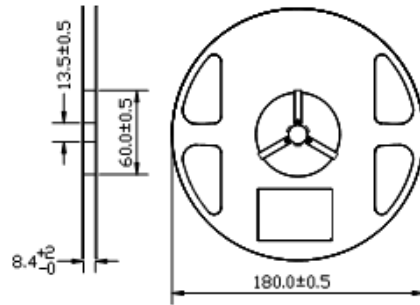

Unit: mm

Tape Dimension:

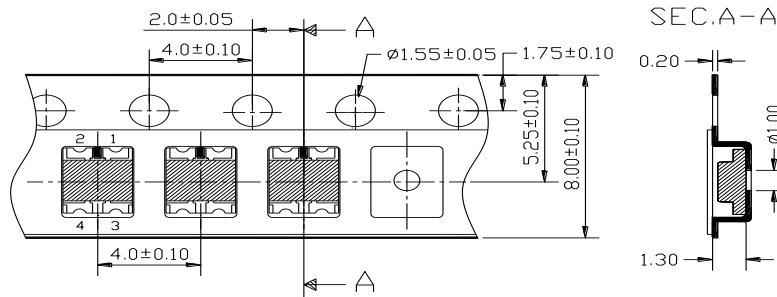

Unit: mm

Arrangement of Tape:

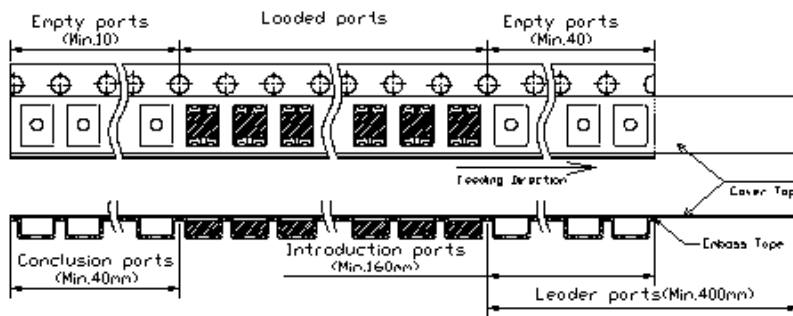

Packaging Specification:

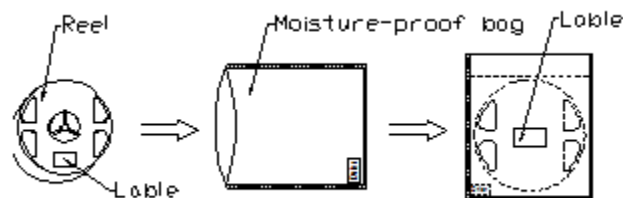

Labeling

Part No: _____

Customer P/N: _____

Item: _____

Q'ty: _____

Vf: _____

Iv: _____

WI: _____

Date: _____

Made in China**Ordering Information**

Part #	Orderable Part #	Spec Range	Quantity per reel
QBLP650-RGB	QBLP650-RGB	Red: Iv=140 mcd typ. @ I _F =20mA, λ _D =615nm to 630nm	3,000 units
		True Green: Iv=500 mcd typ. @ I _F =20mA, λ _D =520nm to 530nm	
		Blue: Iv=100 mcd typ. @ I _F = 20mA, λ _D =465nm to 475nm	

Revision History

Description:	Revision #	Revision Date
New Release of QBLP650-RGB	V1.0	09/20/2010
Quantity and brightness updates	V1.1	06/25/2011
Update format	V2.0	07/15/2013
Amend QTY per reel	V2.1	11/18/2013
Update Packing Spec	V2.2	09/08/2015

Disclaimer

QT-BRIGHTTEK reserves the right to make changes without further notice to any products herein to improve reliability, function or design. QT-BRIGHTTEK does not assume any liability arising out of the application or use of any product or circuit described herein; neither does it convey any license under its patent rights, nor the rights of others.

Life Support Policy

QT-BRIGHTTEK's products are not authorized for use as critical components in life support devices or systems without the express written approval of QT-BRIGHTTEK. As used herein:

1. Life support devices or systems are devices or systems which, (a) are intended for surgical implant into the body, or (b) support or sustain life, and (c) whose failure to perform when properly used in accordance with instructions for use provided in the labeling, can be reasonably expected to result in a significant injury of the user.
2. A critical component in any component of a life support device or system whose failure to perform can be reasonably expected to cause the failure of the life support device or system, or to affect its safety or effectiveness.