

3-1703841-1 ✓ ACTIVE

AMP | Heavy Duty Sealed Connector Series

TE Internal #: 3-1703841-1

Housing for Male Terminals, Wire-to-Wire, 2 Position, .236 in [6 mm] Centerline, Sealable, Green, Signal, Heavy Duty Sealed Connector Series

[View on TE.com >](#)



Connectors > Automotive Connectors > Automotive Housings > Heavy Duty Sealed Connector Series Housings



Connector & Housing Type: **Housing for Male Terminals**

Mating Tab Width: **2.8 mm [ .11 in ]**

Connector System: **Wire-to-Wire**

Number of Positions: **2**

Centerline (Pitch): **6 mm [ .236 in ]**

[All Heavy Duty Sealed Connector Series Housings \(204\)](#)

## Features

### Product Type Features

Connector Shape	Rectangular
Connector & Housing Type	Housing for Male Terminals
Connector System	Wire-to-Wire
Sealable	Yes
Hybrid Connector	No
Primary Locking Feature	On the Terminal

### Configuration Features

Number of Positions	2
Number of Rows	1

### Electrical Characteristics

Operating Voltage	60 VDC
Nominal Voltage Architecture	12 V, 24 V, 42 V, 60 V



### Body Features

Cable Exit Angle	180°, 90°
Primary Product Color	Green
Connector & Keying Code	C

### Contact Features

Contact Size	2.8mm
Contact Type	Tab
Mating Tab Width	2.8 mm[.11 in]
Contact Current Rating (Max)	40 A

### Mechanical Attachment

Terminal Position Assurance	Yes
Strain Relief	Add By Accessory
Mating Alignment Type	Keyed
Mating Alignment	With
Connector Mounting Type	Panel Mount

### Housing Features

Housing Material	PBT GF
Centerline (Pitch)	6 mm[.236 in]

### Dimensions

Connector Height	29.8 mm[1.173 in]
Product Width	48.1 mm[1.894 in]
Product Length	37.5 mm[1.476 in]

### Usage Conditions

Operating Temperature (Max)	70 °C, 80 °C, 85 °C, 90 °C, 100 °C, 105 °C, 110 °C, 120 °C, 125 °C, 130 °C, 140 °C[158 °F][167 °F][176 °F][185 °F][194 °F][212 °F][221 °F][230 °F][248 °F][257 °F][266 °F][284 °F]
Operating Temperature Range	-40 – 140 °C[-40 – 284 °F]

### Operation/Application

Circuit Application	Signal
---------------------	--------

### Industry Standards

Degree of Protection	IP67
UL Flammability Rating	UL 94V-0



### Packaging Features

Packaging Quantity	450
Packaging Method	Carton

### Other

Serviceable	Yes
Connector Position Assurance Capable	No

### Product Compliance

[For compliance documentation, visit the product page on TE.com>](#)

EU RoHS Directive 2011/65/EU	Compliant
EU ELV Directive 2000/53/EC	Compliant
China RoHS 2 Directive MIIT Order No 32, 2016	No Restricted Materials Above Threshold
EU REACH Regulation (EC) No. 1907/2006	Current ECHA Candidate List: JUNE 2023 (235) Candidate List Declared Against: JAN 2023 (233) Does not contain REACH SVHC
Halogen Content	Not Low Halogen - contains Br or Cl > 900 ppm.
Solder Process Capability	Not applicable for solder process capability

#### Product Compliance Disclaimer

This information is provided based on reasonable inquiry of our suppliers and represents our current actual knowledge based on the information they provided. This information is subject to change. The part numbers that TE has identified as EU RoHS compliant have a maximum concentration of 0.1% by weight in homogenous materials for lead, hexavalent chromium, mercury, PBB, PBDE, DBP, BBP, DEHP, DIBP, and 0.01% for cadmium, or qualify for an exemption to these limits as defined in the Annexes of Directive 2011/65/EU (RoHS2). Finished electrical and electronic equipment products will be CE marked as required by Directive 2011/65/EU. Components may not be CE marked. Additionally, the part numbers that TE has identified as EU ELV compliant have a maximum concentration of 0.1% by weight in homogenous materials for lead, hexavalent chromium, and mercury, and 0.01% for cadmium, or qualify for an exemption to these limits as defined in the Annexes of Directive 2000/53/EC (ELV). Regarding the REACH Regulation, the information TE provides on SVHC in articles for this part number is based on the latest European Chemicals Agency (ECHA) 'Guidance on requirements for substances in articles' posted at this URL: <https://echa.europa.eu/guidance-documents/guidance-on-reach>

### Compatible Parts



TE Part # 2112289-1  
PROTECTION CAP, GROUP A, ASSY



TE Part # 3-1418483-1  
2POS, AMP MCP2.8, REC. HSG



TE Part # CAT-H3399-SL34  
Heavy Duty Sealed Connector Series  
Fixing Slides



TE Part # CAT-H3399-B128  
Heavy Duty Sealed Connector Series  
Backshells



TE Part # 828922-1  
2,5MM CAVITY PLUG FOR 5,4MM DI



TE Part # 828905-1  
SINGLE-WIRE-SEAL(5MM HOLE)



TE Part # CAT-T4827-T273  
TIMER, RECEPTACLE AND TAB



TE Part # 1670365-2  
COVER MIXED, 180, 2-3POS, NW4.5

Also in the Series | **Heavy Duty Sealed Connector Series**



Automotive Connector Caps & Covers  
(25)



Automotive Housings(207)



Connector Seals & Cavity Plugs(5)



Data Connectivity Headers(2)



Data Connectivity Housings(18)



Other Automotive Connector  
Accessories(34)



PCB Headers & Receptacles(1)

Customers Also Bought



TE Part #963598-1  
Timer Connector Housing



TE Part #3-1418483-1  
2POS, AMP MCP2.8, REC. HSG



TE Part #953697-2  
MQS, CONNECTOR HOUSING



TE Part #3-967402-1  
2.5MM PIN HOUSING, 2-4POS., ASS



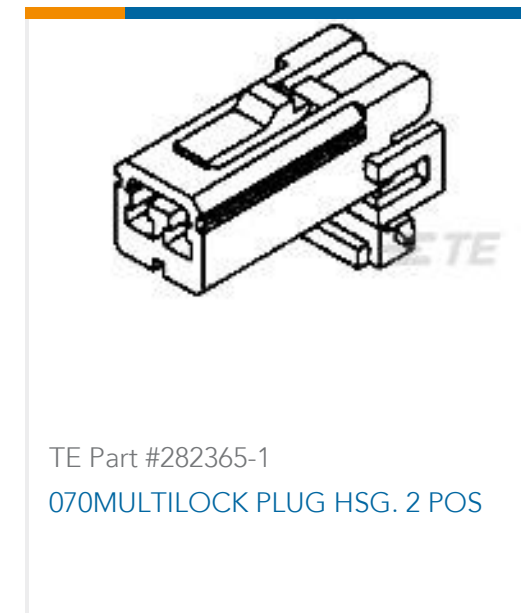

## Documents

### Product Drawings

2POS,TAB 2.8X0.8,TAB HSG,ASSY

English

### CAD Files

Customer View Model

ENG\_CVM\_CVM\_3-1703841-1\_J.2d\_dxf.zip

English

3D PDF

3D

Customer View Model

ENG\_CVM\_CVM\_3-1703841-1\_J.3d\_igs.zip

English

Customer View Model

ENG\_CVM\_CVM\_3-1703841-1\_J.3d\_stp.zip

English

By downloading the CAD file I accept and agree to the [Terms and Conditions](#) of use.

### Datasheets & Catalog Pages

HDSCS Catalog

English

ICT Terminals and Connectors Catalogue

English

CONNECTOR SELECTOR

English

### Product Specifications

Application Specification

English