

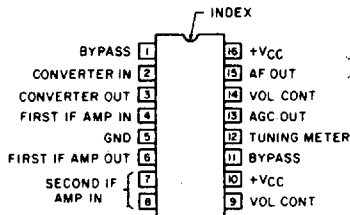

SK3146

AM RF/IF/AF Subsystem
 Outline No. IC-017



SK3149

TV Chroma Amp-Demodulator
 Outline No. IC-017

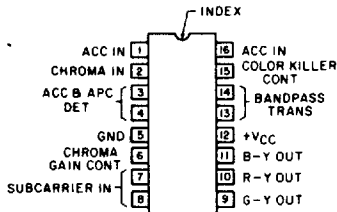

SK3152

6.5W Audio Amp
 Outline No. IC-029

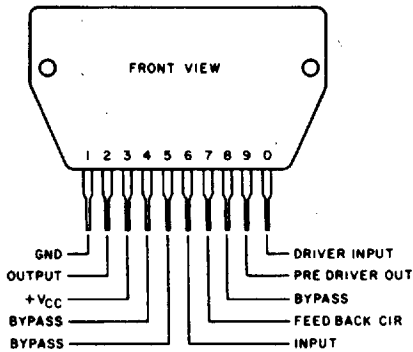

SK3154

15W Audio Amp
 Outline No. IC-031

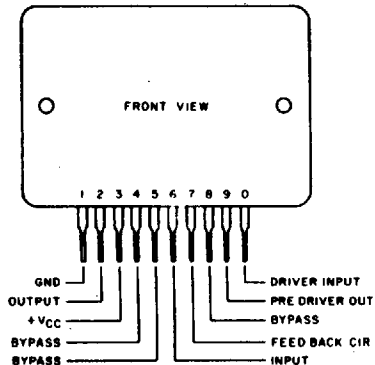

SK3155

10W Audio Amps
 Outline No. IC-028

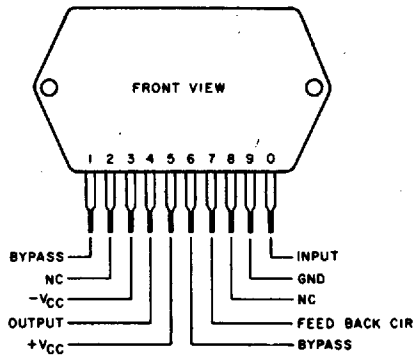

SK3158

TV Chroma Signal Processor
 Outline No. IC-017**

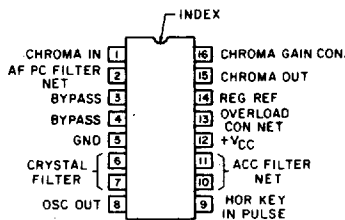

SK3159

FM MPX Stereo Decoder
 Outline No. IC-015

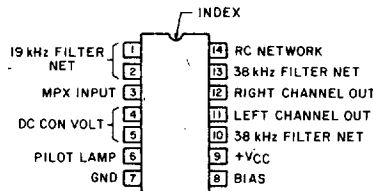

SK3160

FM MPX Stereo Decoder
 Outline No. IC-015

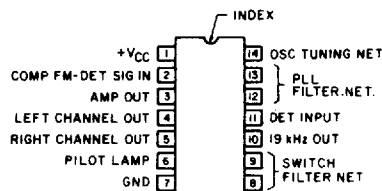

SK3167

TV Chroma Signal Processor
 Outline No. IC-015

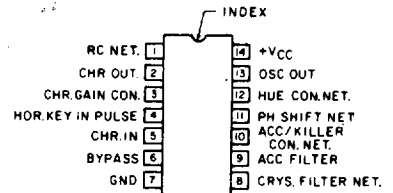

SK3172

FM Multiplex Stereo Decoder
 Outline No. IC-017

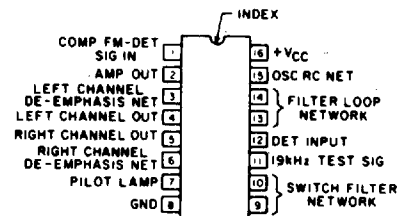

SK3184

7W Audio Power Amp
 Outline No. IC-026

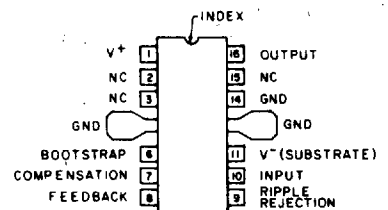

SK3205

TV Chroma Signal Processor
 Outline No. IC-017

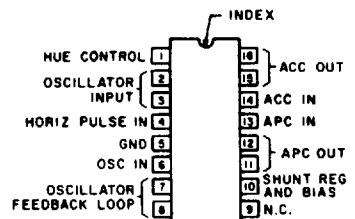

** Leads are quad formed (staggered)